

## Thermostat KSD301

### SPECIFICATION

- Electrical Rating : 16A 125V AC (Resistive Load)  
10A 250V AC (Resistive Load)  
16A 250V AC (Resistive Load)
- Operating Temp : 50 ~ 175°C (UL.CUL 205°C)
- Differential : 10~30K (15K Standard)
- Temp. Tolerance : Operating Temp.±3K±5K
- Heat Durability : 220°C Max. (PPS)
- Circuit Resistance : 50mΩ Max.
- Insulation Resistance : 100MΩ Min.at DC500V
- Dielectric Strength : AC 1000V for One Minute.  
or AC 1800V for One Second.
- Operating Life : 100000 Cycles (16A 125V/10A 250V AC)  
10000 Cycles (16A 250V AC)



### HOW TO ORDER

#### MODEL CODE (FULL CODE)

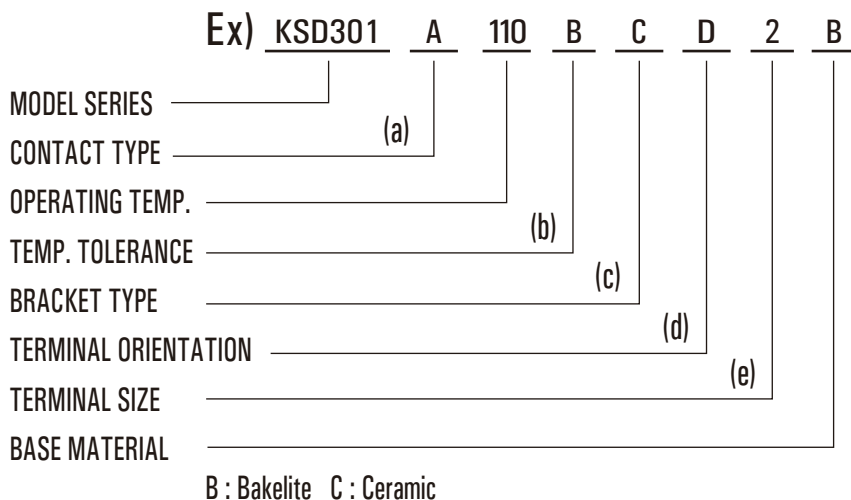

#### (a) CONTACT TYPE :

A = Contact Opens When Temperature Rises to Set Point (Normally Closed)



B = Contact Closes When Temperature Rises to Set Point (Normally Open)



M = Manual Reset

#### (b) TEMP. TOLERANCE : (\*=STANDARD)

Grade	A	*B
Action ± °C	3	5
Reset ± °C	4	8

• The Grade of Temp. Tolerance is "A", When The Operating Temp. is Less Than 105°C.

• The Grade of Temp. Tolerance is "B", When The Operating Temp. is Over 106°C.

**(c) BRACKET TYPE :**

● **FIXED BRACKET**

\* STAINLESS STEEL CAP : D,DL,V,T TYPE

SCREW TYPE : M4x0.7 L:6mm (STD)  
M5x0.8 L:6mm (STD)  
#6-32UNC  
#8-32UNC

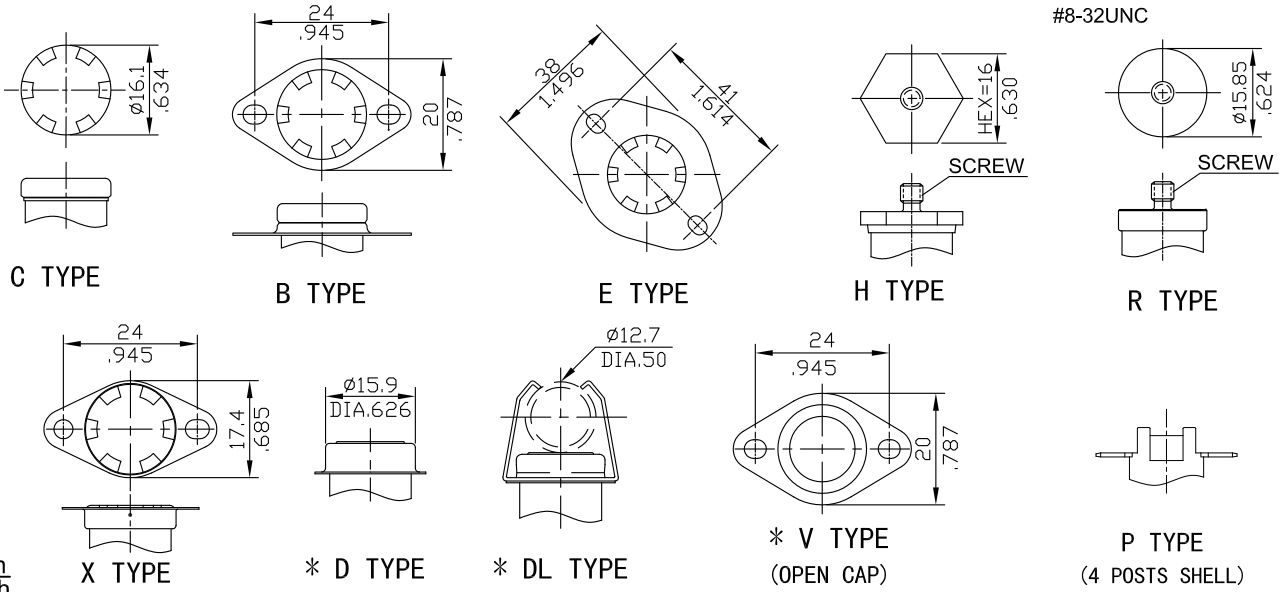

● **LOOSE BRACKET**

\* STAINLESS STEEL CAP : U TYPE

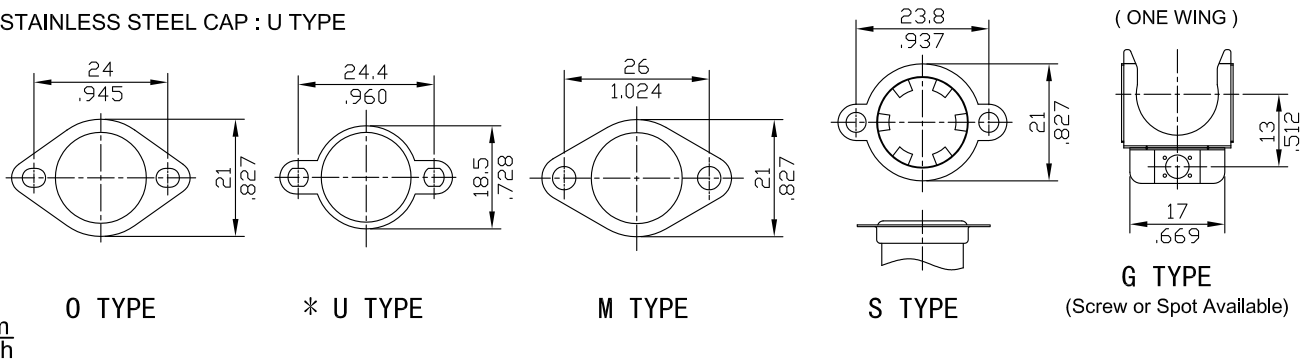

**(d) TERMINAL ORIENTATION:**

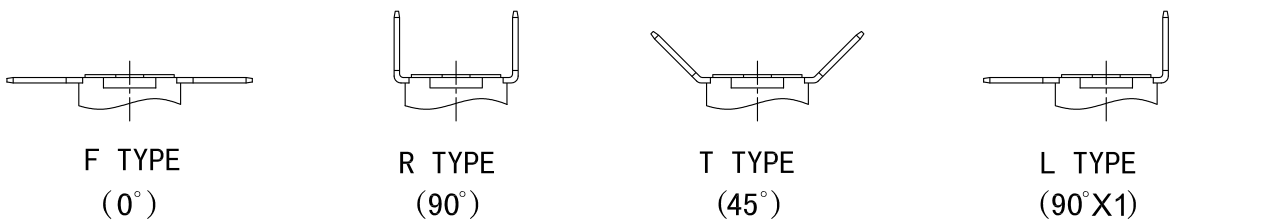

**(e) TERMINAL SIZE:**

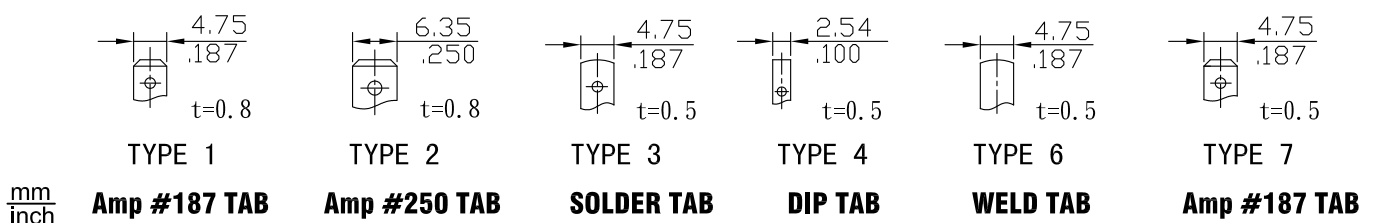

# Thermostat KSD301



## KSD301A-CF2

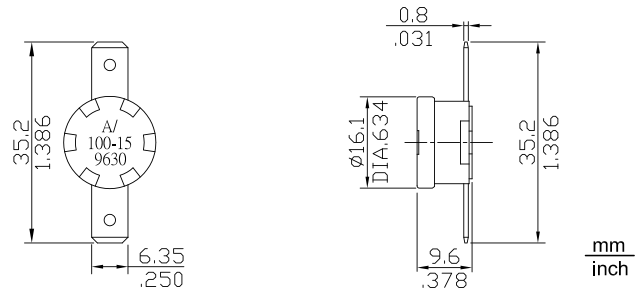

## KSD301A-CR1-OS(ONE SHOT)

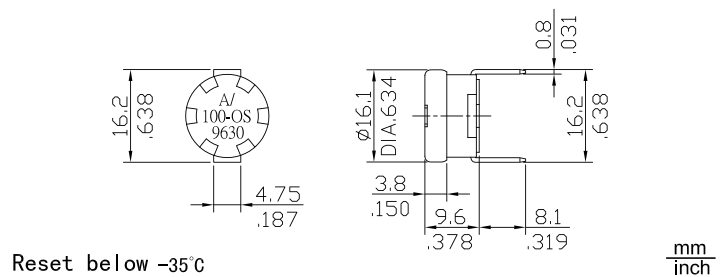

## KSD301A-SF2(LOOSE BRACKET)

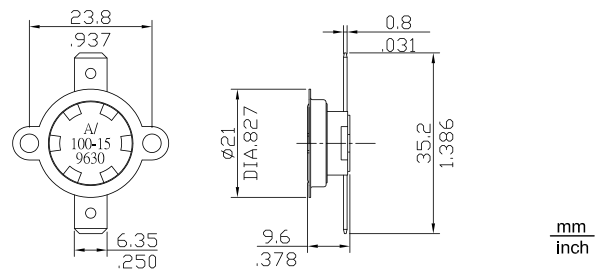

## KSD301A-PF2(4-POST)

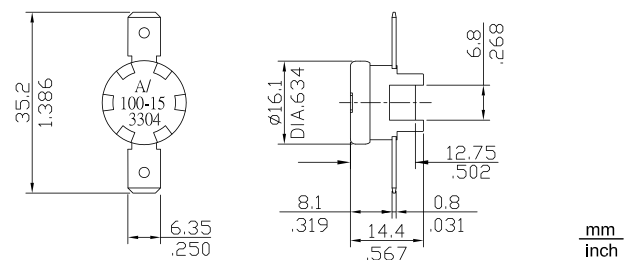

## KSD301A-XF2(FIX BRACKET)

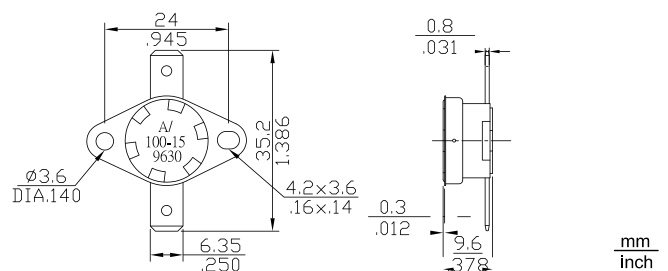

# Thermostat KSD301



## KSD301M-RF2

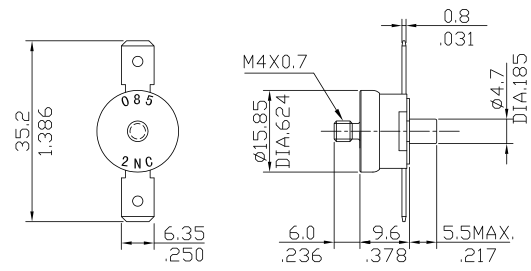

mm  
inch

## KSD301A-HF1

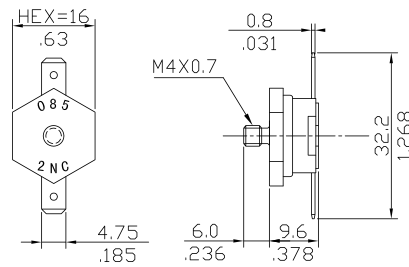

mm  
inch

## KSD301A-HR1

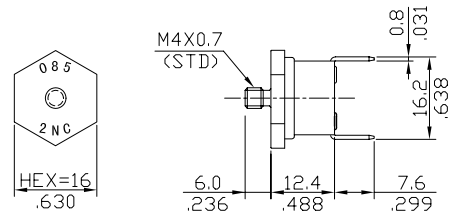

mm  
inch

## KSD301A-RF2-A

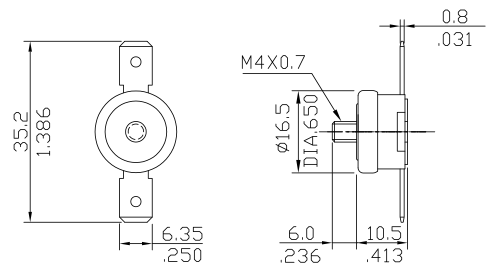

mm  
inch

## KSD301A-RF2-A

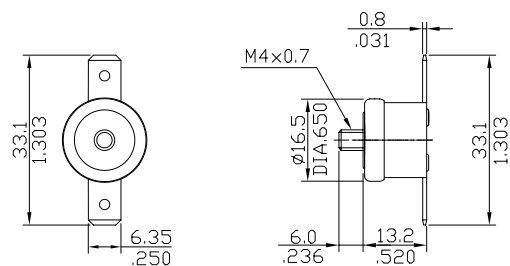

mm  
inch

## KSD301A-BF2

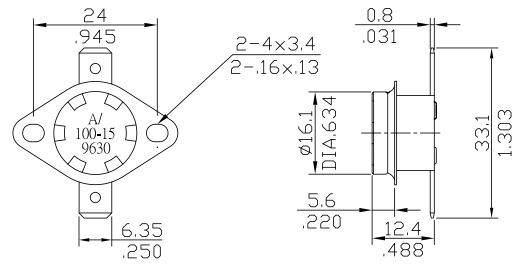

mm  
inch

## KSD301B-CF2

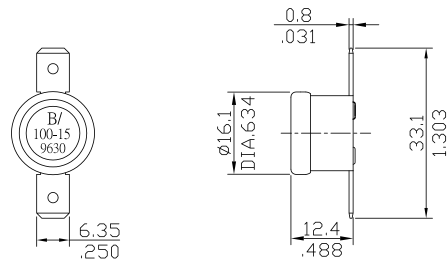

mm  
inch

## KSD301M-DF2

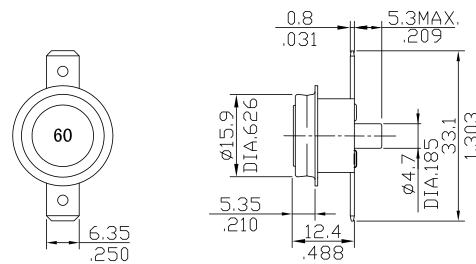

mm  
inch

## KSD301A-CR4



(FOR PCB)

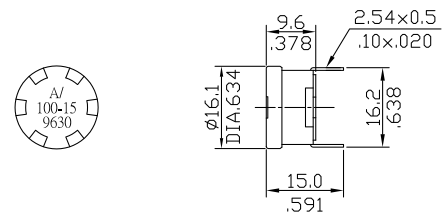

mm  
inch

## KSD301A-DR2-E

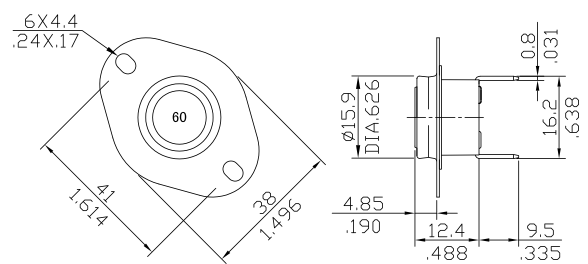

mm  
inch

## KSD301A-SF2-U

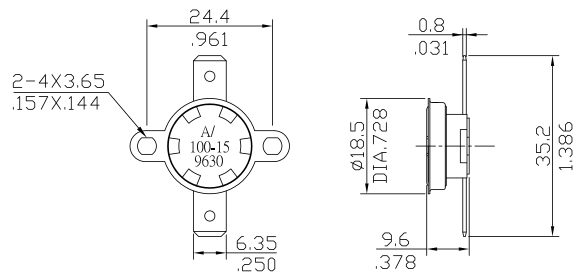

mm  
inch

## KSD301A-SF2(LOOSE BRACKET)

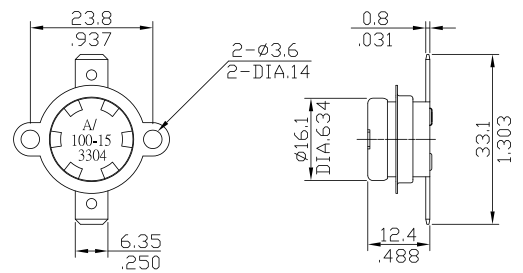

mm  
inch

## KSD301A-XF1(FIX BRACKET)

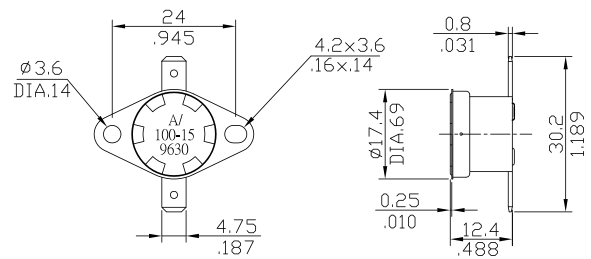

mm  
inch

## KSD301A-BF2-V(OPEN CAP)

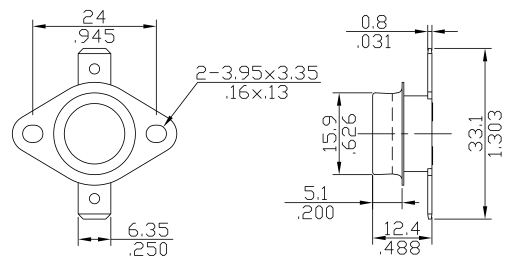

mm  
inch