

HIGH VOLTAGE FAST-SWITCHING NPN POWER TRANSISTOR

- SGS-THOMSON PREFERRED SALESTYPE
- HIGH VOLTAGE CAPABILITY
- U.L. RECOGNISED ISOWATT218 PACKAGE (U.L. FILE # E81734 (N))
- NPN TRANSISTOR WITH INTEGRATED FREEWHEELING DIODE

APPLICATIONS:

- HORIZONTAL DEFLECTION FOR COLOUR TV

DESCRIPTION

The BUH515D is manufactured using Multi-epitaxial Mesa technology for cost-effective high performance and uses a Hollow Emitter structure to enhance switching speeds.

The BUH series is designed for use in horizontal deflection circuits in televisions and monitors.

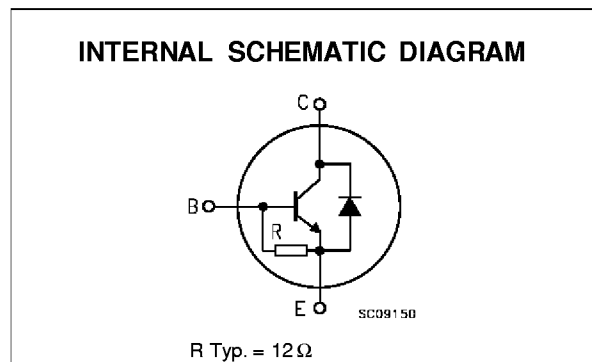
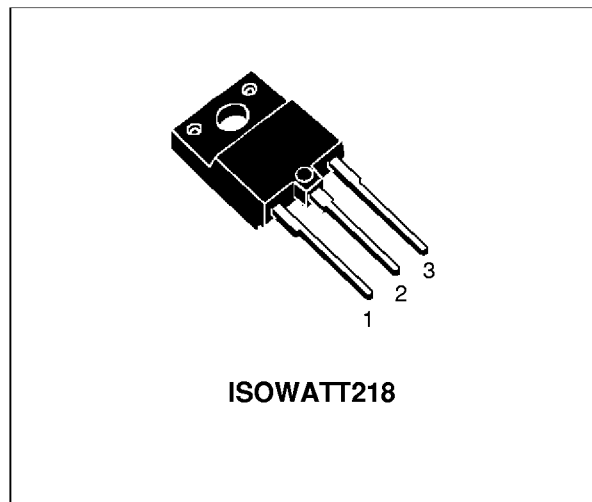

ABSOLUTE MAXIMUM RATINGS

Symbol	Parameter	Value	Unit
V_{CBO}	Collector-Base Voltage ($I_E = 0$)	1500	V
V_{CEO}	Collector-Emitter Voltage ($I_B = 0$)	700	V
V_{EBO}	Emitter-Base Voltage ($I_C = 0$)	5	V
I_C	Collector Current	8	A
I_{CM}	Collector Peak Current ($t_p < 5$ ms)	15	A
I_B	Base Current	5	A
I_{BM}	Base Peak Current ($t_p < 5$ ms)	8	A
P_{tot}	Total Dissipation at $T_c = 25$ °C	50	W
T_{stg}	Storage Temperature	-65 to 150	°C
T_j	Max. Operating Junction Temperature	150	°C

BUH515D

THERMAL DATA

$R_{thj-case}$	Thermal Resistance Junction-case	Max	2.5	$^{\circ}C/W$
----------------	----------------------------------	-----	-----	---------------

ELECTRICAL CHARACTERISTICS ($T_{case} = 25^{\circ}C$ unless otherwise specified)

Symbol	Parameter	Test Conditions	Min.	Typ.	Max.	Unit
I_{CES}	Collector Cut-off Current ($V_{BE} = 0$)	$V_{CE} = 1300 V$ $V_{CE} = 1500 V$ $V_{CE} = 1500 V \quad T_j = 125^{\circ}C$			10 1 2	μA mA mA
I_{EBO}	Emitter Cut-off Current ($I_C = 0$)	$V_{EB} = 5 V$			200	mA
$V_{CE(sat)*}$	Collector-Emitter Saturation Voltage	$I_C = 5 A \quad I_B = 1.25 A$			1.5	V
$V_{BE(sat)*}$	Base-Emitter Saturation Voltage	$I_C = 5 A \quad I_B = 1.25 A$			1.3	V
h_{FE*}	DC Current Gain	$I_C = 5 A \quad V_{CE} = 5 V$ $I_C = 5 A \quad V_{CE} = 5 V \quad T_j = 100^{\circ}C$	5 3		10	
t_s t_f	RESISTIVE LOAD Storage Time Fall Time	$V_{CC} = 400 V \quad I_C = 5 A$ $I_{B1} = 1.5 A \quad I_{B2} = -2.5 A$		2.4 170	3.6 260	μs ns
t_s t_f	INDUCTIVE LOAD Storage Time Fall Time	$I_C = 5 A \quad f = 15625 Hz$ $I_{B1} = 1.25 A \quad I_{B2} = -2.5 A$ $V_{ceflyback} = 1050 \sin\left(\frac{\pi}{10} 10^6\right) t \quad V$		3.5 450		μs ns
V_F	Diode Forward Voltage	$I_F = 5 A$			2	V

* Pulsed: Pulse duration = 300 μs , duty cycle 1.5 %

Safe Operating Area

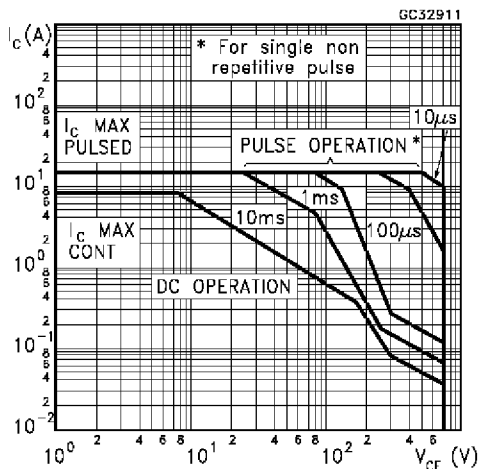

Thermal Impedance

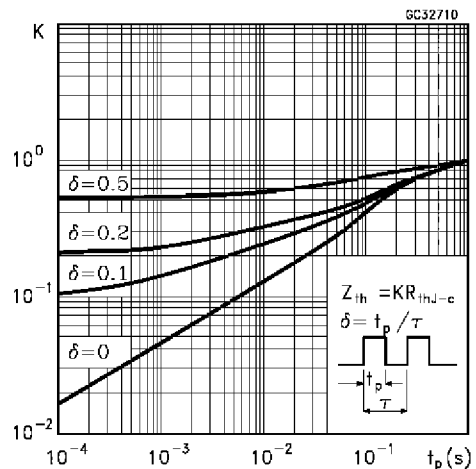

Derating Curve

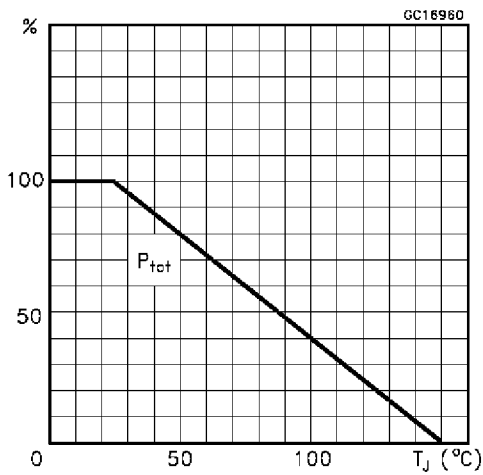

DC Current Gain

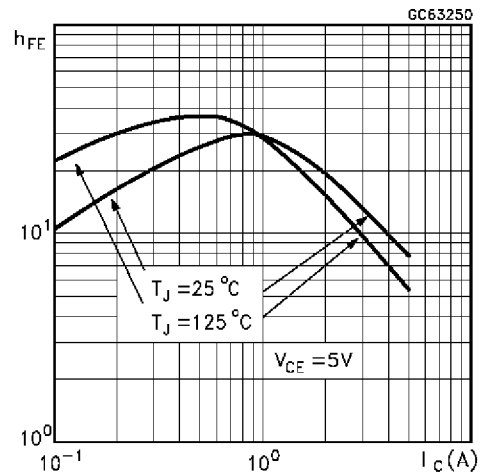

Collector Emitter Saturation Voltage

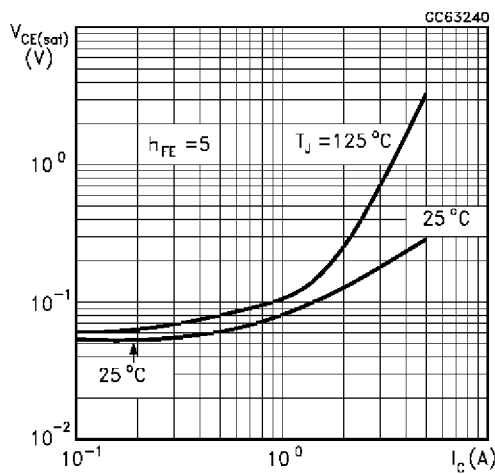

Base Emitter Saturation Voltage

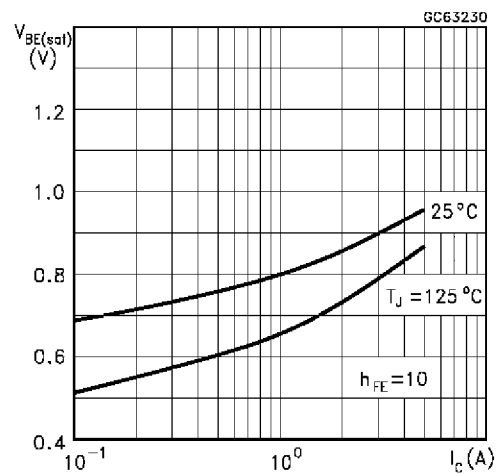

Power Losses at 16 KHz

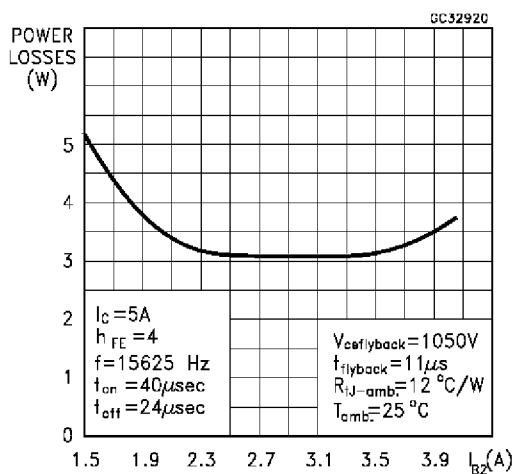

Switching Time Inductive Load at 16KHz (see figure 2)

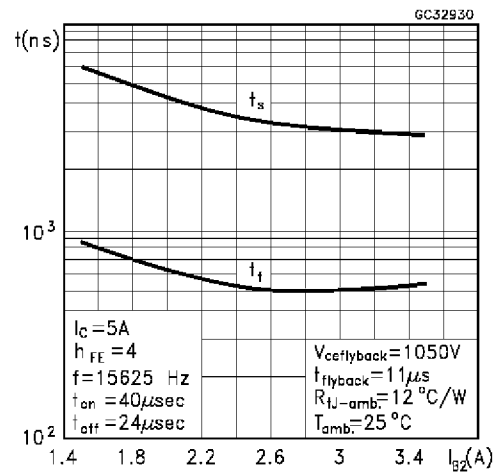

Switching Time Resistive Load

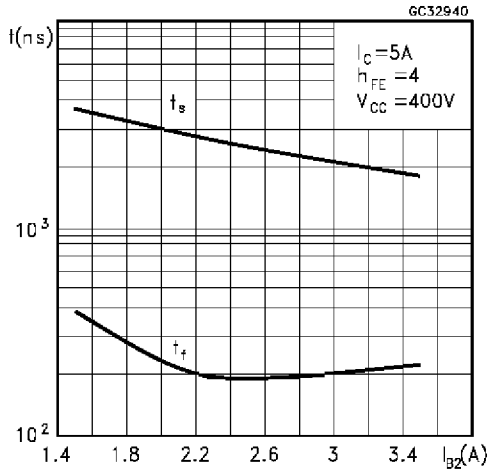

BASE DRIVE INFORMATION

In order to saturate the power switch and reduce conduction losses, adequate direct base current I_{B1} has to be provided for the lowest gain h_{FE} at 100 °C (line scan phase). On the other hand, negative base current I_{B2} must be provided to turn off the power transistor (retrace phase). Most of the dissipation, especially in the deflection application, occurs at switch-off. Therefore it is essential to determine the value of I_{B2} which minimizes power losses, fall time t_f and, consequently, T_j . A new set of curves have been defined to give total power losses, t_s and t_f as a function of I_{B2} at 16 KHz frequencies for choosing the optimum negative drive. The test circuit is illustrated in fig. 1.

Inductance L_1 serves to control the slope of the negative base current I_{B2} to recombine the excess carrier in the collector when base current is still present, this avoid any tailing phenomenon in the collector current.

The values of L and C are calculated from the following equations:

$$\frac{1}{2} L (I_C)^2 = \frac{1}{2} C (V_{CEfly})^2$$

$$\omega = 2 \pi f = \frac{1}{\sqrt{LC}}$$

Where I_C = operating collector current, V_{CEfly} = flyback voltage, f = frequency of oscillation during retrace.

Figure 1: Inductive Load Switching Test Circuit

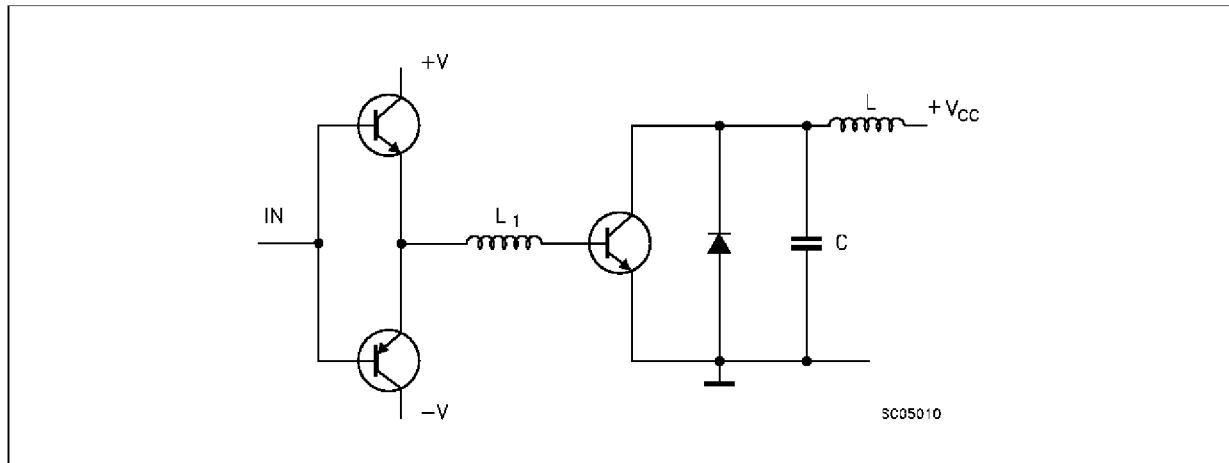
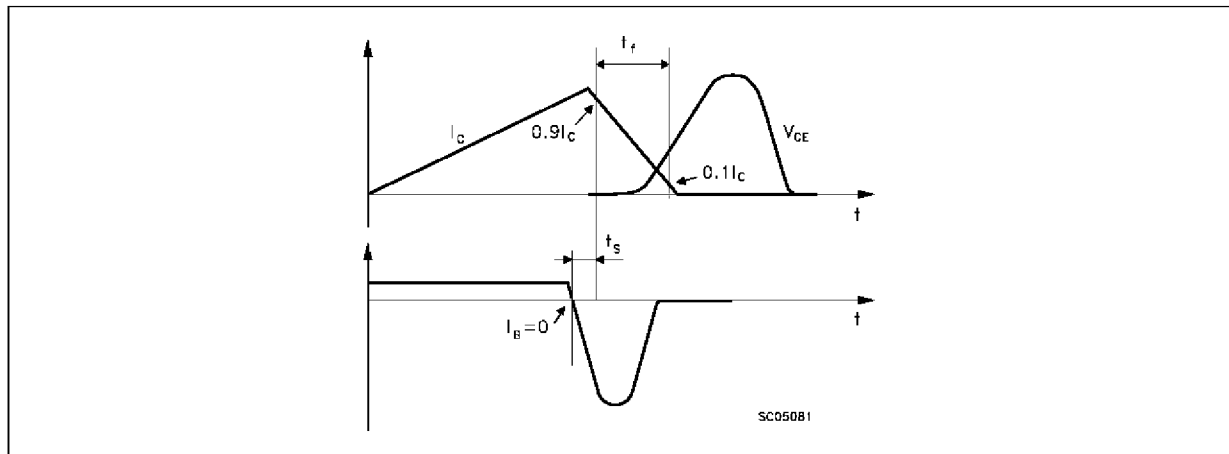
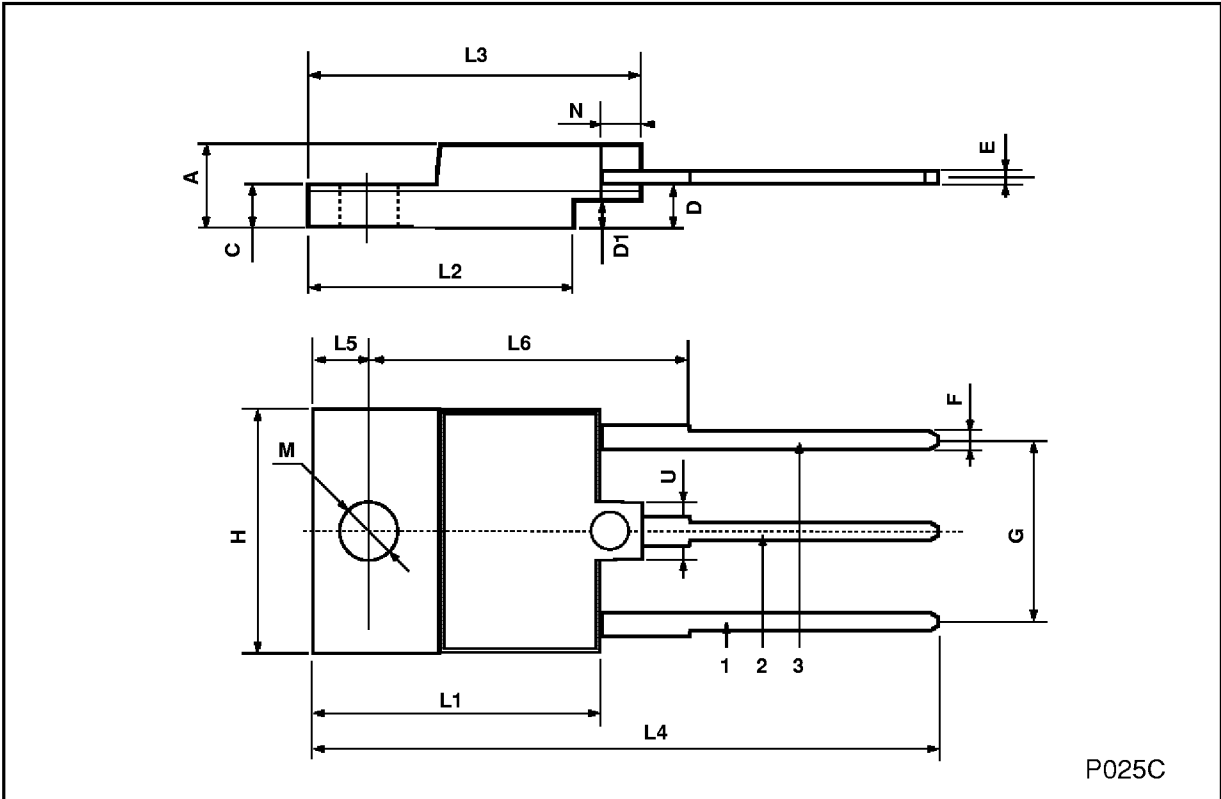

Figure 2: Switching Waveforms in a Deflection Circuit



ISOWATT218 MECHANICAL DATA

DIM.	mm			inch		
	MIN.	TYP.	MAX.	MIN.	TYP.	MAX.
A	5.35		5.65	0.210		0.222
C	3.3		3.8	0.130		0.149
D	2.9		3.1	0.114		0.122
D1	1.88		2.08	0.074		0.081
E	0.75		1	0.029		0.039
F	1.05		1.25	0.041		0.049
G	10.8		11.2	0.425		0.441
H	15.8		16.2	0.622		0.637
L1	20.8		21.2	0.818		0.834
L2	19.1		19.9	0.752		0.783
L3	22.8		23.6	0.897		0.929
L4	40.5		42.5	1.594		1.673
L5	4.85		5.25	0.190		0.206
L6	20.25		20.75	0.797		0.817
M	3.5		3.7	0.137		0.145
N	2.1		2.3	0.082		0.090
U		4.6			0.181	



Information furnished is believed to be accurate and reliable. However, SGS-THOMSON Microelectronics assumes no responsibility for the consequences of use of such information nor for any infringement of patents or other rights of third parties which may result from its use. No license is granted by implication or otherwise under any patent or patent rights of SGS-THOMSON Microelectronics. Specifications mentioned in this publication are subject to change without notice. This publication supersedes and replaces all information previously supplied. SGS-THOMSON Microelectronics products are not authorized for use as critical components in life support devices or systems without express written approval of SGS-THOMSON Microelectronics.

© 1996 SGS-THOMSON Microelectronics - Printed in Italy - All Rights Reserved

SGS-THOMSON Microelectronics GROUP OF COMPANIES

Australia - Brazil - Canada - China - France - Germany - Hong Kong - Italy - Japan - Korea - Malaysia - Malta - Morocco - The Netherlands - Singapore - Spain - Sweden - Switzerland - Taiwan - Thailand - United Kingdom - U.S.A