

HFA25TB60

Ultrafast, Soft Recovery Diode

Features

- Ultrafast Recovery
- Ultrasoft Recovery
- Very Low I_{RRM}
- Very Low Q_{rr}
- Guaranteed Avalanche
- Specified at Operating Conditions

Benefits

- Reduced RFI and EMI
- Reduced Power Loss in Diode and Switching Transistor
- Higher Frequency Operation
- Reduced Snubbing
- Reduced Parts Count

Description

International Rectifier's HFA25TB60 is a state of the art center tap ultra fast recovery diode. Employing the latest in epitaxial construction and advanced processing techniques it features a superb combination of characteristics which result in performance which is unsurpassed by any rectifier previously available. With basic ratings of 600 volts and 25 amps continuous current, the HFA25TB60 is especially well suited for use as the companion diode for IGBTs and MOSFETs. In addition to ultra fast recovery time, the HEXFRED product line features extremely low values of peak recovery current (I_{RRM}) and does not exhibit any tendency to "snap-off" during the t_b portion of recovery. The HEXFRED features combine to offer designers a rectifier with lower noise and significantly lower switching losses in both the diode and the switching transistor. These HEXFRED advantages can help to significantly reduce snubbing, component count and heatsink sizes. The HEXFRED HFA25TB60 is ideally suited for applications in power supplies and power conversion systems (such as inverters), motor drives, and many other similar applications where high speed, high efficiency is needed.

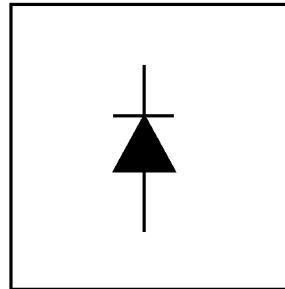

$V_R = 600V$
$V_F(\text{typ.})^* = 1.3V$
$I_{F(AV)} = 25A$
$Q_{rr}(\text{typ.}) = 112nC$
$I_{RRM} = 10A$
$t_{rr}(\text{typ.}) = 23ns$
$di_{(rec)M}/dt(\text{typ.}) = 250A/\mu s$

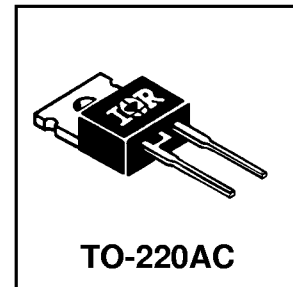

Absolute Maximum Ratings

	Parameter	Max.	Units
V_R	Cathode-to-Anode Voltage	600	V
$I_F @ T_C = 25^\circ C$	Continuous Forward Current		A
$I_F @ T_C = 100^\circ C$	Continuous Forward Current	25	
I_{FSM}	Single Pulse Forward Current	225	
I_{FRM}	Maximum Repetitive Forward Current	100	
$I_{AR}^{\text{①}}$	Maximum Repetitive Avalanche Current	2.0	
$P_D @ T_C = 25^\circ C$	Maximum Power Dissipation	125	W
$P_D @ T_C = 100^\circ C$	Maximum Power Dissipation	50	
T_J	Operating Junction and	-55 to +150	C
T_{STG}	Storage Temperature Range		

* 125°C

HFA25TB60

International
IOR Rectifier

Electrical Characteristics @ T_J = 25°C (unless otherwise specified)

	Parameter	Min.	Typ.	Max.	Units	Test Conditions
V _{BR}	Cathode Anode Breakdown Voltage	600	---	---	V	I _R = 100μA
V _{FM}	Max Forward Voltage	---	1.3	1.7	V	I _F = 25A
		---	1.5	2.0		I _F = 50A
		---	1.3	1.7		I _F = 25A, T _J = 125°C
I _{RM}	Max Reverse Leakage Current	---	1.5	20	μA	V _R = V _R Rated
		---	600	2000		T _J = 125°C, V _R = 0.8 x V _R Rated
C _T	Junction Capacitance	---	55	100	pF	V _R = 200V
L _S	Series Inductance	---	8.0	---	nH	Measured lead to lead 5mm from package body

Dynamic Recovery Characteristics @ T_J = 25°C (unless otherwise specified)

	Parameter	Min.	Typ.	Max.	Units	Test Conditions
t _{rr}	Reverse Recovery Time	---	23	---	ns	I _F = 1.0A, di _F /dt = 200A/μs, V _R = 30V
t _{rr1}	See Fig. 5, 6 & 16	---	50	75		T _J = 25°C
t _{rr2}		---	105	160		T _J = 125°C
I _{RRM1}	Peak Recovery Current	---	4.5	10	A	T _J = 25°C
I _{RRM2}	See Fig. 7 & 8	---	8.0	15		T _J = 125°C
Q _{rr1}	Reverse Recovery Charge	---	112	375	nC	T _J = 25°C
Q _{rr2}	See Fig. 9 & 10	---	420	1200		T _J = 125°C
di _{(rec)M} /dt1	Peak Rate of Fall of Recovery Current	---	250	---	A/μs	T _J = 25°C
di _{(rec)M} /dt2	During t _b See Fig. 11 & 12	---	160	---		T _J = 125°C

Thermal - Mechanical Characteristics

	Parameter	Min.	Typ.	Max.	Units
T _{lead} ②	Lead Temperature	---	---	300	°C
R _{θJC}	Thermal Resistance, Junction to Case	---	---	1.0	K/W
R _{θJA} ③	Thermal Resistance, Junction to Ambient	---	---	80	
R _{θCS} ④	Thermal Resistance, Case to Heat Sink	---	0.5	---	
Wt	Weight	---	2.0	---	
		---	0.07	---	(oz)
	Mounting Torque	6.0	---	12	Kg-cm
		5.0	---	10	lbf•in

- ① L=100μH, duty cycle limited by max T_J
- ② 0.063 in. from Case (1.6mm) for 10 sec
- ③ Typical Socket Mount
- ④ Mounting Surface, Flat, Smooth and Greased

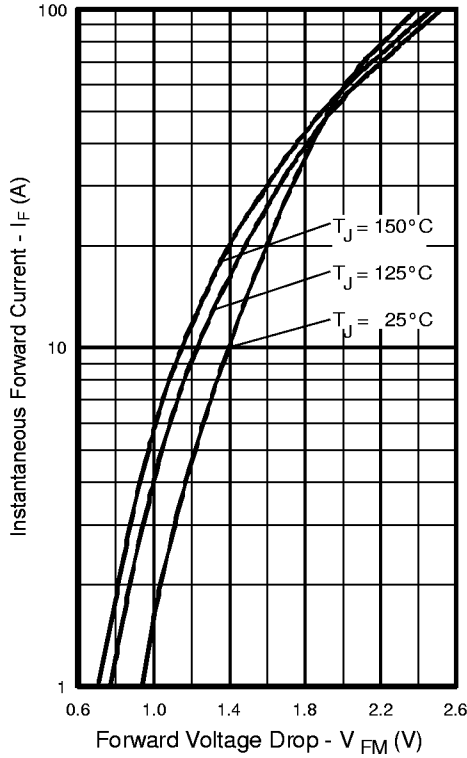

Fig. 1 - Maximum Forward Voltage Drop vs. Instantaneous Forward Current

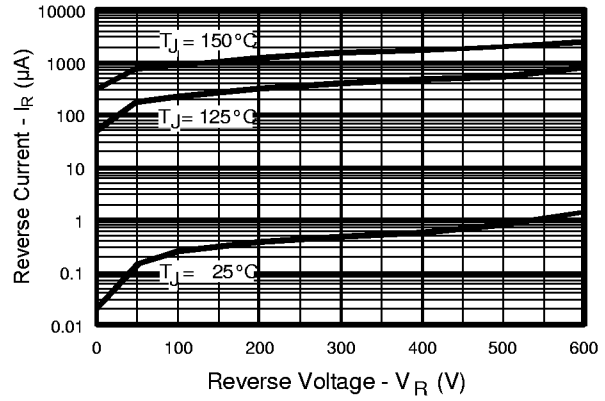

Fig. 2 - Typical Reverse Current vs. Reverse Voltage

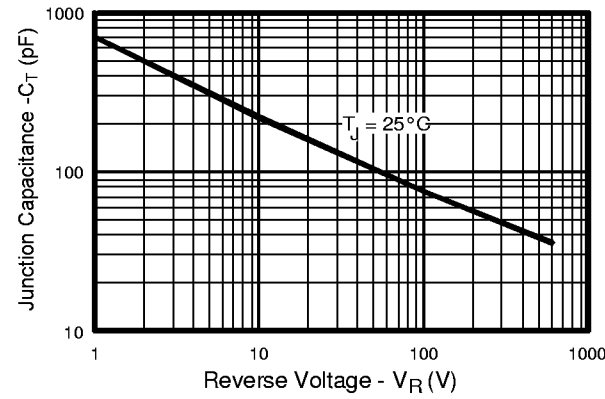

Fig. 3 - Typical Junction Capacitance vs. Reverse Voltage

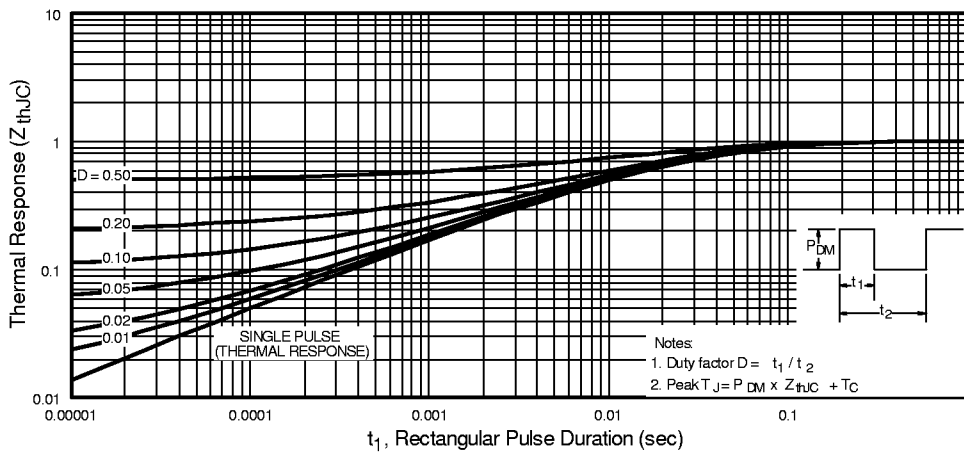

Fig. 4 - Maximum Thermal Impedance Z_{thJC} Characteristics

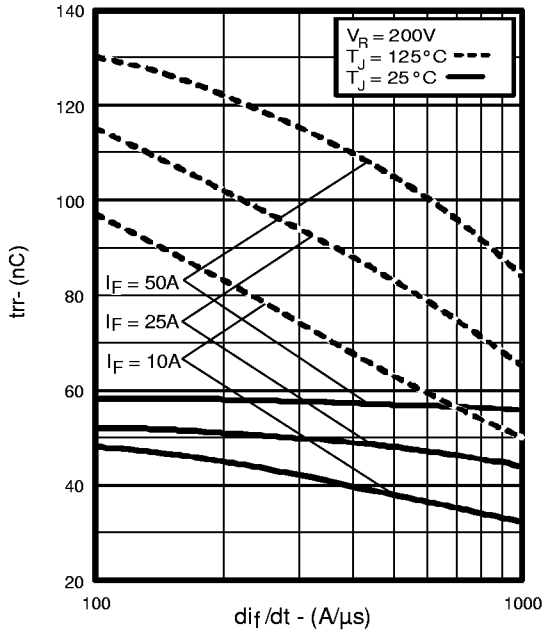

Fig. 5 - Typical Reverse Recovery vs. di_f/dt

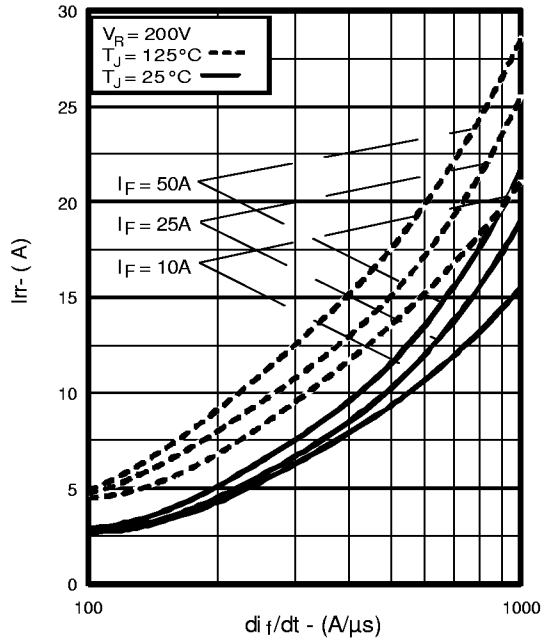

Fig. 6 - Typical Recovery Current vs. di_f/dt

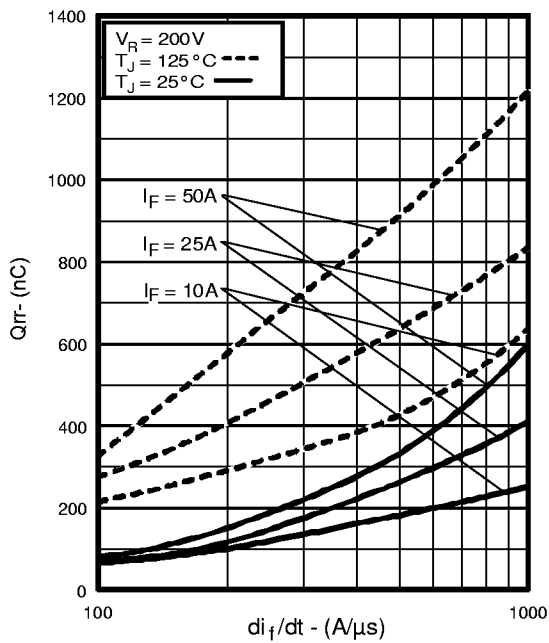

Fig. 7 - Typical Stored Charge vs. di_f/dt

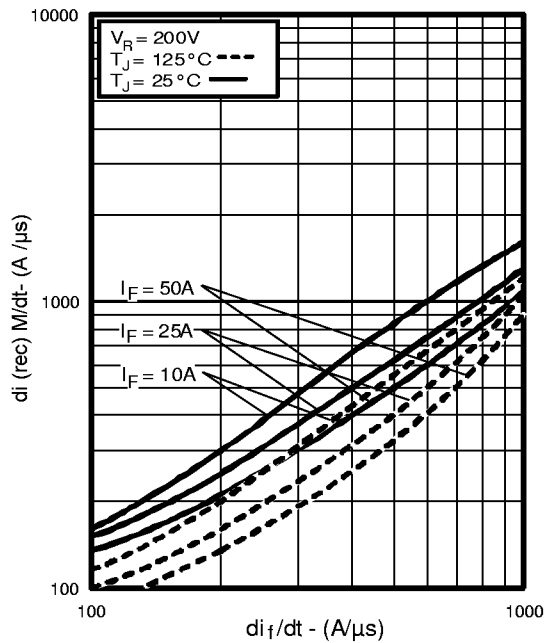

Fig. 8 - Typical $di_{(rec)M}/dt$ vs. di_f/dt

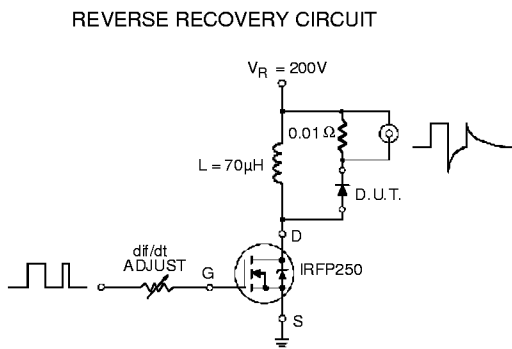
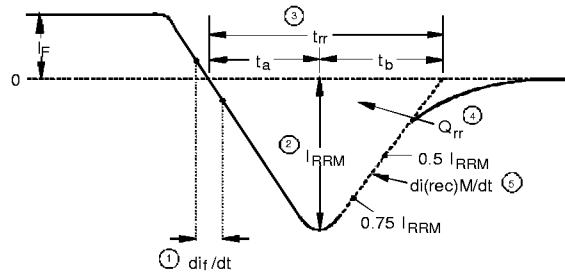

Fig. 9 - Reverse Recovery Parameter Test Circuit



1. di/dt - Rate of change of current through zero crossing
2. I_{RRM} - Peak reverse recovery current
3. t_{rr} - Reverse recovery time measured from zero crossing point of negative going I_F to point where a line passing through $0.75 I_{RRM}$ and $0.50 I_{RRM}$ extrapolated to zero current
4. Q_{rr} - Area under curve defined by t_{rr} and I_{RRM}

$$Q_{rr} = \frac{t_{rr} \times I_{RRM}}{2}$$
5. $di_{(rec)M}/dt$ - Peak rate of change of current during t_b portion of t_{rr}

Fig. 10 - Reverse Recovery Waveform and Definitions

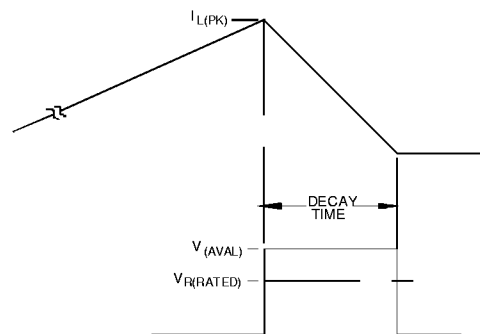
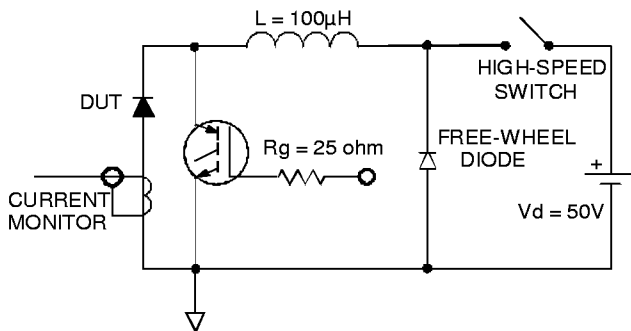
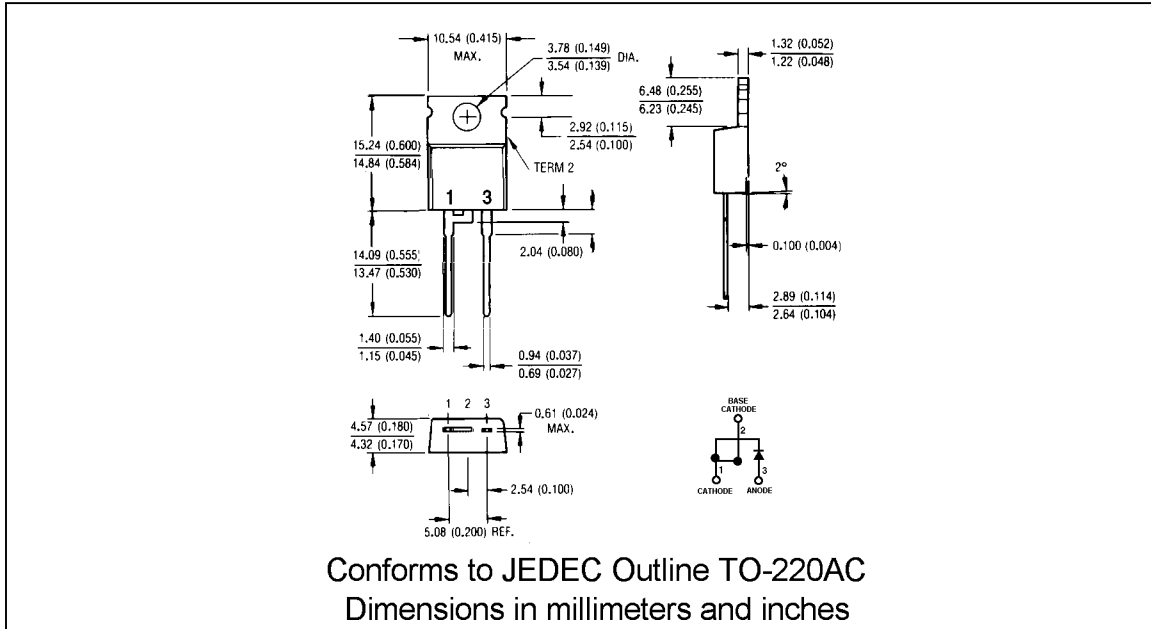

Fig. 11 - Avalanche Test Circuit and Waveforms

HFA25TB60

International
IOR Rectifier



International
IOR Rectifier

WORLD HEADQUARTERS: 233 Kansas St., El Segundo, California 90245, Tel: (310) 322 3331

EUROPEAN HEADQUARTERS: Hurst Green, Oxted, Surrey RH8 9BB, UK Tel: ++ 44 1883 732020

IR CANADA: 7321 Victoria Park Ave., Suite 201, Markham, Ontario L3R 2Z8, Tel: (905) 475 1897

IR GERMANY: Saalburgstrasse 157, 61350 Bad Homburg Tel: ++ 49 6172 96590

IR ITALY: Via Liguria 49, 10071 Borgaro, Torino Tel: ++ 39 11 451 0111

IR FAR EAST: K&H Bldg., 2F, 30-4 Nishi-Ikebukuro 3-Chome, Toshima-Ku, Tokyo Japan 171 Tel: 81 3 3983 0086

IR SOUTHEAST ASIA: 315 Outram Road, #10-02 Tan Boon Liat Building, Singapore 0316 Tel: 65 221 8371

<http://www.irf.com/>

Data and specifications subject to change without notice.

4/97