

SS9018

SS9018

AM/FM Amplifier, Local Oscillator of FM/VHF Tuner

- High Current Gain Bandwidth Product $f_T=1.1$ GHz (Typ)

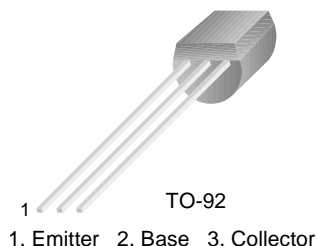

NPN Epitaxial Silicon Transistor

Absolute Maximum Ratings $T_a=25^\circ\text{C}$ unless otherwise noted

Symbol	Parameter	Ratings	Units
V_{CBO}	Collector-Base Voltage	30	V
V_{CEO}	Collector-Emitter Voltage	15	V
V_{EBO}	Emitter-Base Voltage	5	V
I_C	Collector Current	50	mA
P_C	Collector Power Dissipation	400	mW
T_J	Junction Temperature	150	$^\circ\text{C}$
T_{STG}	Storage Temperature	-55 ~ 150	$^\circ\text{C}$

Electrical Characteristics $T_a=25^\circ\text{C}$ unless otherwise noted

Symbol	Parameter	Test Condition	Min.	Typ.	Max.	Units
BV_{CBO}	Collector-Base Breakdown Voltage	$I_C=100\mu\text{A}, I_E=0$	30			V
BV_{CEO}	Collector-Emitter Breakdown Voltage	$I_C=1.0\text{mA}, I_B=0$	15			V
BV_{EBO}	Emitter-Base Breakdown Voltage	$I_E=100\mu\text{A}, I_C=0$	5			V
I_{CBO}	Collector Cut-off Current	$V_{CB}=12\text{V}, I_E=0$			50	nA
h_{FE}	Emitter Cut-off Current	$V_{CE}=5\text{V}, I_C=1.0\text{mA}$	28	100	198	
$V_{CE}(\text{sat})$	Collector-Emitter Saturation Voltage	$I_C=10\text{mA}, I_B=1\text{mA}$			0.5	V
C_{ob}	Output Capacitance	$V_{CB}=10\text{V}, I_E=0$ $f=1\text{MHz}$		1.3	1.7	pF
f_T	Current Gain Bandwidth Product	$V_{CE}=5\text{V}, I_C=5\text{mA}$	700	1100		MHz

h_{FE} Classification

Classification	D	E	F	G	H	I
h_{FE}	28 ~ 45	39 ~ 60	54 ~ 80	72 ~ 108	97 ~ 146	132 ~ 198

Typical Characteristics

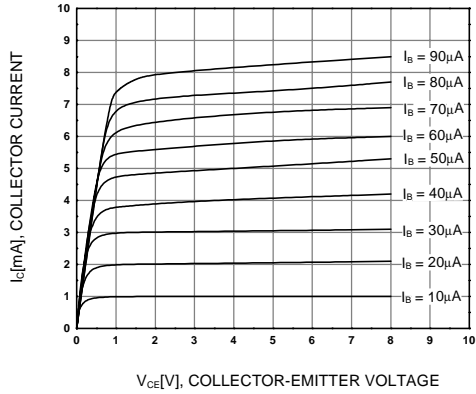

Figure 1. Static Characteristic

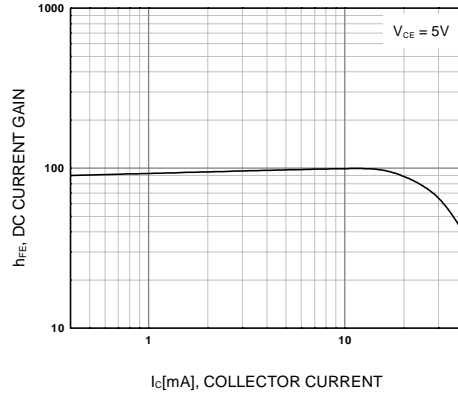

Figure 2. DC current Gain

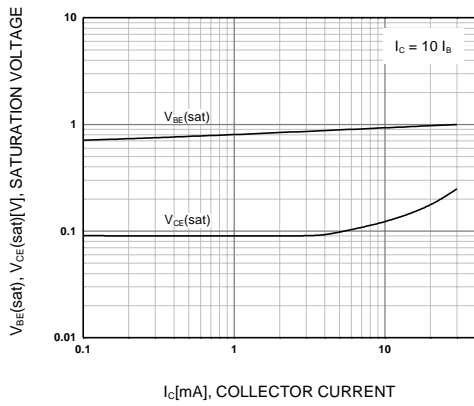

Figure 3. Base-Emitter Saturation Voltage
Collector-Emitter Saturation Voltage

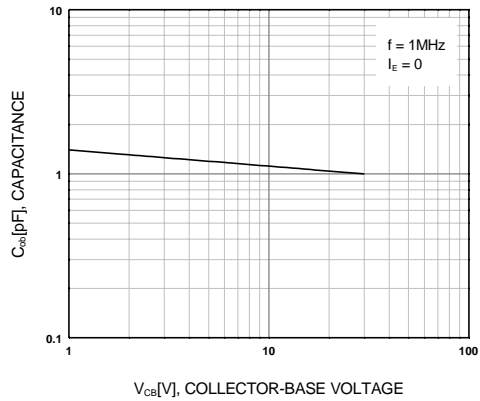

Figure 4. Output Capacitance

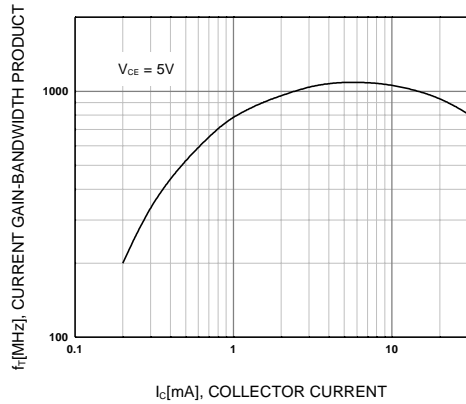
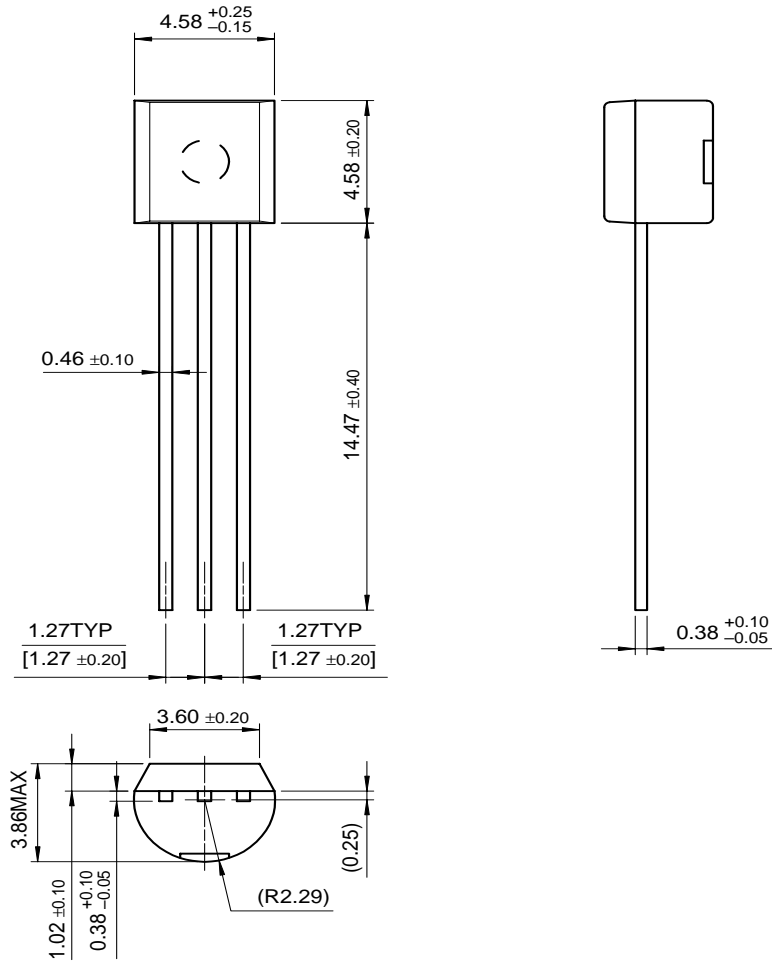

Figure 5. Current Gain Bandwidth Product

Package Dimensions

SS9018

TO-92



Dimensions in Millimeters

TRADEMARKS

The following are registered and unregistered trademarks Fairchild Semiconductor owns or is authorized to use and is not intended to be an exhaustive list of all such trademarks.

ACE _x TM	FAST [®]	MICROWIRE TM	SLIENT SWITCHER [®]	UHC TM
Bottomless TM	FAST _r TM	OPTOLOGIC TM	SMART START TM	UltraFET [®]
CoolFET TM	FRFET TM	OPTOPLANAR TM	SPM TM	VCX TM
CROSSVOLT TM	GlobalOptoisolator TM	PACMAN TM	STAR*POWER TM	
DenseTrench TM	GTO TM	POP TM	Stealth TM	
DOMET TM	HiSeC TM	Power247 TM	SuperSOT TM -3	
EcoSPARK TM	I ² C TM	PowerTrench [®]	SuperSOT TM -6	
E ² CMOS TM	ISOPLANAR TM	QFET TM	SuperSOT TM -8	
EnSigna TM	LittleFET TM	QS TM	SyncFET TM	
FACT TM	MicroFET TM	QT Optoelectronics TM	TinyLogic TM	
FACT Quiet Series TM	MicroPak TM	Quiet Series TM	TruTranslation TM	

STAR*POWER is used under license

DISCLAIMER

FAIRCHILD SEMICONDUCTOR RESERVES THE RIGHT TO MAKE CHANGES WITHOUT FURTHER NOTICE TO ANY PRODUCTS HEREIN TO IMPROVE RELIABILITY, FUNCTION OR DESIGN. FAIRCHILD DOES NOT ASSUME ANY LIABILITY ARISING OUT OF THE APPLICATION OR USE OF ANY PRODUCT OR CIRCUIT DESCRIBED HEREIN; NEITHER DOES IT CONVEY ANY LICENSE UNDER ITS PATENT RIGHTS, NOR THE RIGHTS OF OTHERS.

LIFE SUPPORT POLICY

FAIRCHILD'S PRODUCTS ARE NOT AUTHORIZED FOR USE AS CRITICAL COMPONENTS IN LIFE SUPPORT DEVICES OR SYSTEMS WITHOUT THE EXPRESS WRITTEN APPROVAL OF FAIRCHILD SEMICONDUCTOR CORPORATION.

As used herein:

1. Life support devices or systems are devices or systems which, (a) are intended for surgical implant into the body, or (b) support or sustain life, or (c) whose failure to perform when properly used in accordance with instructions for use provided in the labeling, can be reasonably expected to result in significant injury to the user.
2. A critical component is any component of a life support device or system whose failure to perform can be reasonably expected to cause the failure of the life support device or system, or to affect its safety or effectiveness.

PRODUCT STATUS DEFINITIONS

Definition of Terms

Datasheet Identification	Product Status	Definition
Advance Information	Formative or In Design	This datasheet contains the design specifications for product development. Specifications may change in any manner without notice.
Preliminary	First Production	This datasheet contains preliminary data, and supplementary data will be published at a later date. Fairchild Semiconductor reserves the right to make changes at any time without notice in order to improve design.
No Identification Needed	Full Production	This datasheet contains final specifications. Fairchild Semiconductor reserves the right to make changes at any time without notice in order to improve design.
Obsolete	Not In Production	This datasheet contains specifications on a product that has been discontinued by Fairchild semiconductor. The datasheet is printed for reference information only.

Fairchild Semiconductor

SEARCH | [Parametric](#) | [Cross Reference](#)

space

Product Folders and

Applies

find products

[Home](#) >> [Find products](#) >>

[Products groups](#)

[Analog and Mixed](#)

[Signal](#)

[Discrete](#)

[Interface](#)

[Logic](#)

[Microcontrollers](#)

[Non-Volatile](#)

[Memory](#)

[Optoelectronics](#)

[Markets and](#)

[applications](#)

[New products](#)

[Product selection and](#)

[parametric search](#)

[Cross-reference](#)

[search](#)

SS9018

NPN Epitaxial Silicon Transistor

Contents

[Features](#) | [Applications](#) | [Product status/pricing/packaging](#)

Features

- High Current Gain Bandwidth Product
 $f_T=1.1\text{GHz}$ (Typ)

[back to top](#)

Applications

AM/FM Amplifier, Local Oscillator of FM/VHF Tuner

[back to top](#)

Product status/pricing/packaging

Product	Product status	Pricing*	Package type	Leads	Packing method
SS9018FBU	Full Production	\$0.05	TO-92	3	BULK
SS9018HBU	Full Production	\$0.05	TO-92	3	BULK
SS9018GBU	Full Production	\$0.05	TO-92	3	BULK

* 1,000 piece Budgetary Pricing

[back to top](#)

[Home](#) | [Find products](#) | [Technical information](#) | [Buy products](#) | [Support](#) | [Company](#) | [Contact us](#) | [Site index](#) | [Privacy policy](#)

© Copyright 2002 Fairchild Semiconductor

Related Links

[Request samples](#)

[How to order products](#)

[Product Change Notices \(PCNs\)](#)

[Support](#)

[Distributor and field sales representatives](#)

[Quality and reliability](#)

[Design tools](#)

Datasheet

[Download this datasheet](#)

PDF

[e-mail this datasheet](#)

[E-]

This page

[Print version](#)