

Silicon NPN Power Transistors

2SC3886

DESCRIPTION

- With TO-3P(H)IS package
- High speed
- High voltage

APPLICATIONS

- Horizontal deflection output for high resolution display
- High speed switching regulator output applications

PINNING

PIN	DESCRIPTION
1	Base
2	Collector
3	Emitter

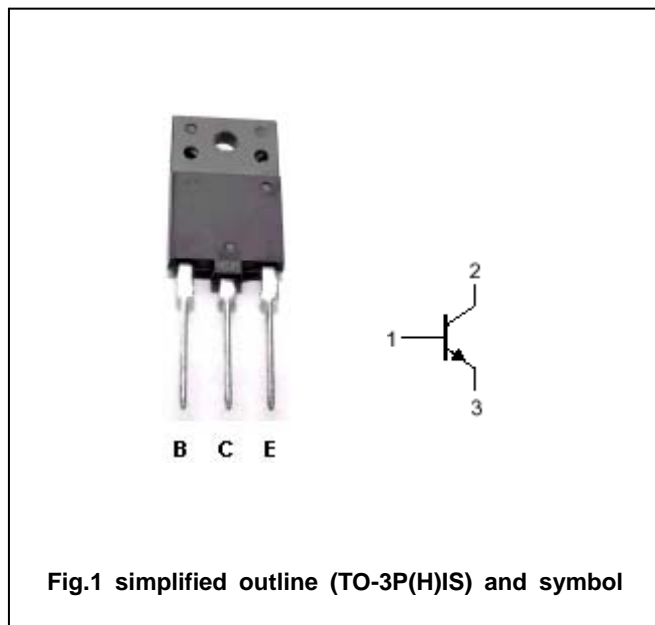

Absolute maximum ratings(Ta=25°C)

SYMBOL	PARAMETER	CONDITIONS	VALUE	UNIT
V_{CBO}	Collector-base voltage	Open emitter	1400	V
V_{CEO}	Collector-emitter voltage	Open base	600	V
V_{EBO}	Emitter-base voltage	Open collector	5	V
I_C	Collector current		8	A
I_{CM}	Collector current-peak		15	A
I_B	Base current		4	A
P_T	Total power dissipation	$T_C=25^\circ\text{C}$	50	W
T_j	Junction temperature		150	$^\circ\text{C}$
T_{stg}	Storage temperature		-55~150	$^\circ\text{C}$

Silicon NPN Power Transistors

2SC3886

CHARACTERISTICS

T_j=25°C unless otherwise specified

SYMBOL	PARAMETER	CONDITIONS	MIN	TYP.	MAX	UNIT
V _{(BR)CEO}	Collector-emitter breakdown voltage	I _C =5mA ; I _B =0	600			V
V _{CEsat}	Collector-emitter saturation voltage	I _C =6A; I _B =1.5A			5	V
V _{BEsat}	Base-emitter saturation voltage	I _C =6A; I _B =1.5A			5	V
I _{CBO}	Collector cut-off current	V _{CB} =1400V; I _E =0			1.0	mA
I _{EBO}	Emitter cut-off current	V _{EB} =5V; I _C =0			10	μ A
h _{FE}	DC current gain	I _C =1A ; V _{CE} =5V	8	15		
C _{ob}	Collector output capacitance	I _E =0 ; V _{CB} =10V, f=1MHz		150		pF
f _T	Transition frequency	I _E =0.1A ; V _{CE} =10V		3	8	MHz

Switching times inductive load

t _s	Storage time	I _{CP} =6A; I _{B1} =1.2A f _H =64kHz L _Y =120 μ H; C _Y =7500pF		2.5	4.0	μ s
t _f	Fall time			0.1	0.5	μ s

Silicon NPN Power Transistors

2SC3886

PACKAGE OUTLINE

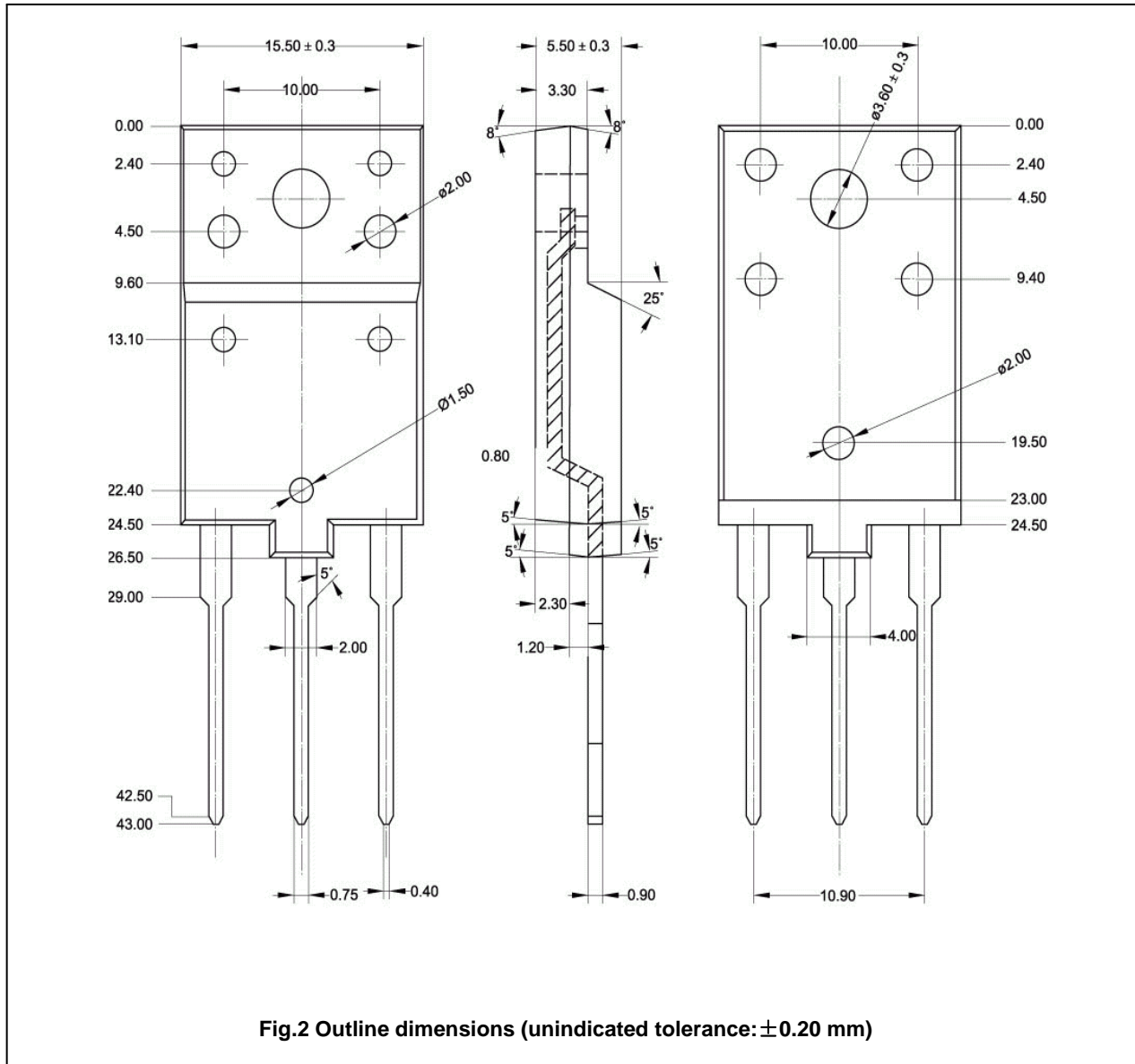

Fig.2 Outline dimensions (unindicated tolerance: ± 0.20 mm)

Silicon NPN Power Transistors

2SC3886

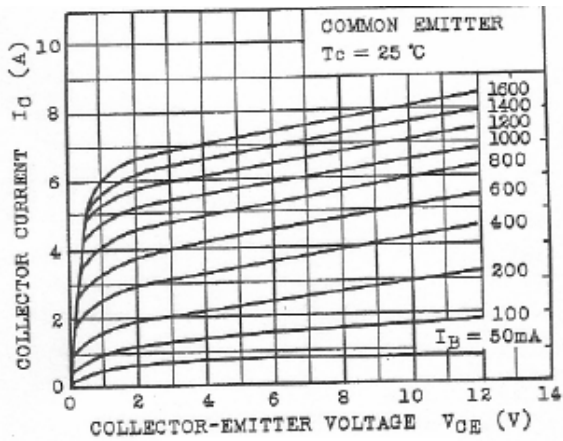

Fig.3 Static Characteristic

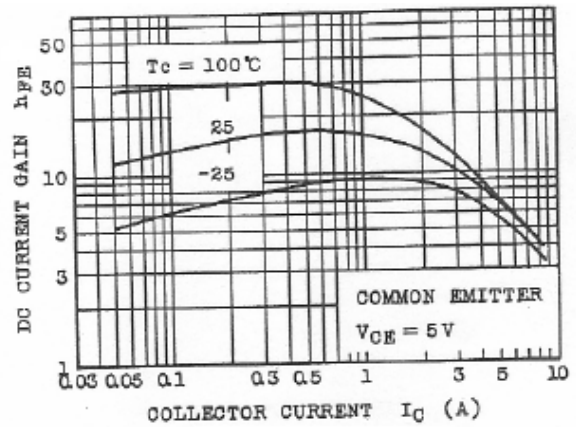

Fig.4 DC current Gain

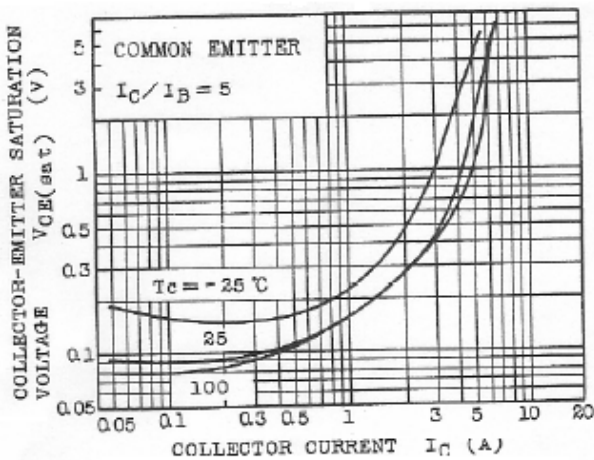

Fig.5 Collector-Emitter Saturation Voltage

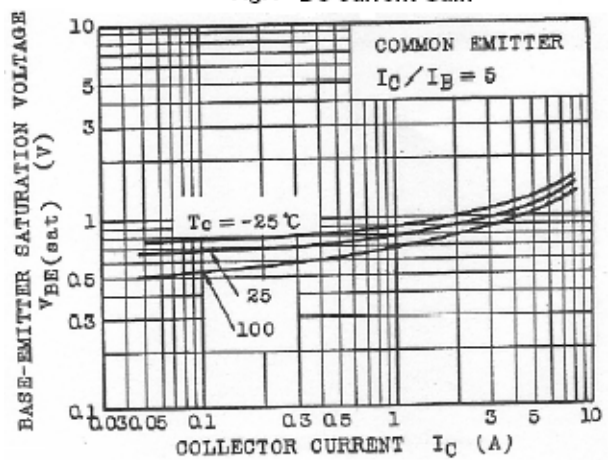

Fig.6 Base-Emitter Saturation Voltage

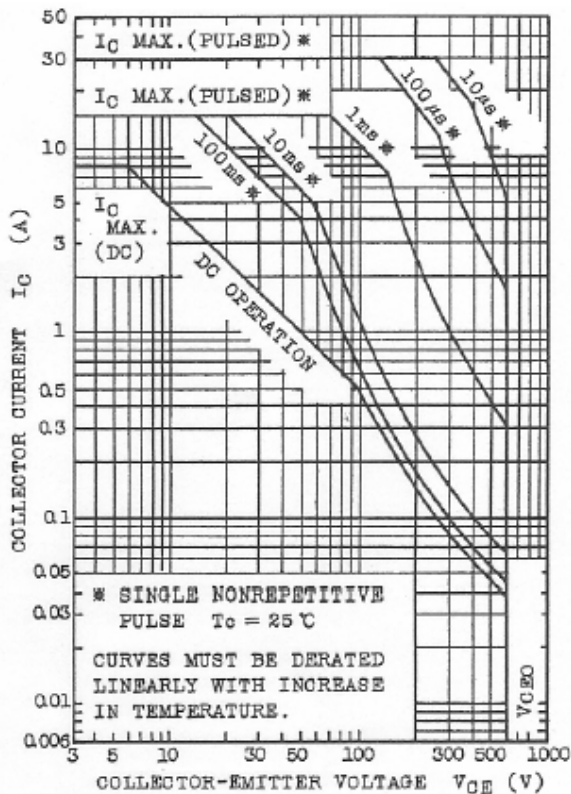

Fig.7 Safe Operating Area