



78MXX

LINEAR INTEGRATED CIRCUIT

3-TERMINAL 0.5A POSITIVE VOLTAGE REGULATOR

DESCRIPTION

The UTC **78MXX** family is monolithic fixed voltage regulator integrated circuit. They are suitable for applications that required supply current up to 0.5A.

FEATURES

- * Output Current up to 0.5A
- * Fixed Output Voltage of 5V, 6V, 8V, 9V, 12V, 15V, 18V and 24V Available
- * Thermal Overload Shutdown Protection
- * Short Circuit Current Limiting
- * Output Transistor SOA Protection

ORDERING INFORMATION

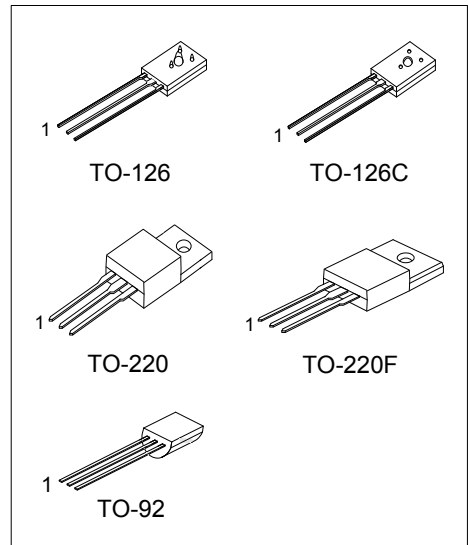

Ordering Number			Package	Pin Assignment			Packing
Normal	Lead Free	Halogen Free		1	2	3	
78Mxx-T60-K	78MxxL-T60-K	78MxxG-T60-K	TO-126	I	G	O	Bulk
78Mxx-T6C-K	78MxxL-T6C-K	78MxxG-T6C-K	TO-126C	I	G	O	Bulk
78Mxx-T92-B	78MxxL-T92-B	78MxxG-T92-B	TO-92	O	G	I	Tape Box
78Mxx-T92-K	78MxxL-T92-K	78MxxG-T92-K	TO-92	O	G	I	Bulk
78Mxx-TA3-T	78MxxL-TA3-T	78MxxG-TA3-T	TO-220	I	G	O	Tube
78Mxx-TF3-T	78MxxL-TF3-T	78MxxG-TF3-T	TO-220F	I	G	O	Tube

<p>78MxxL-T60-K</p> <p>(1)Packing Type (2)Package Type (3)Lead Plating (4)Output Voltage</p>	<p>(1) B: Tape Box, K: Bulk, T: Tube (2) T60: TO-126, T6C: TO-126C, T92: TO-92, TA3: TO-220, TF3: TO-220F (3) G: Halogen Free, L: Lead Free Plating, Blank: Pb/Sn (4) xx: refer to Marking Information</p>
--	--

■ BLOCK DIAGRAM

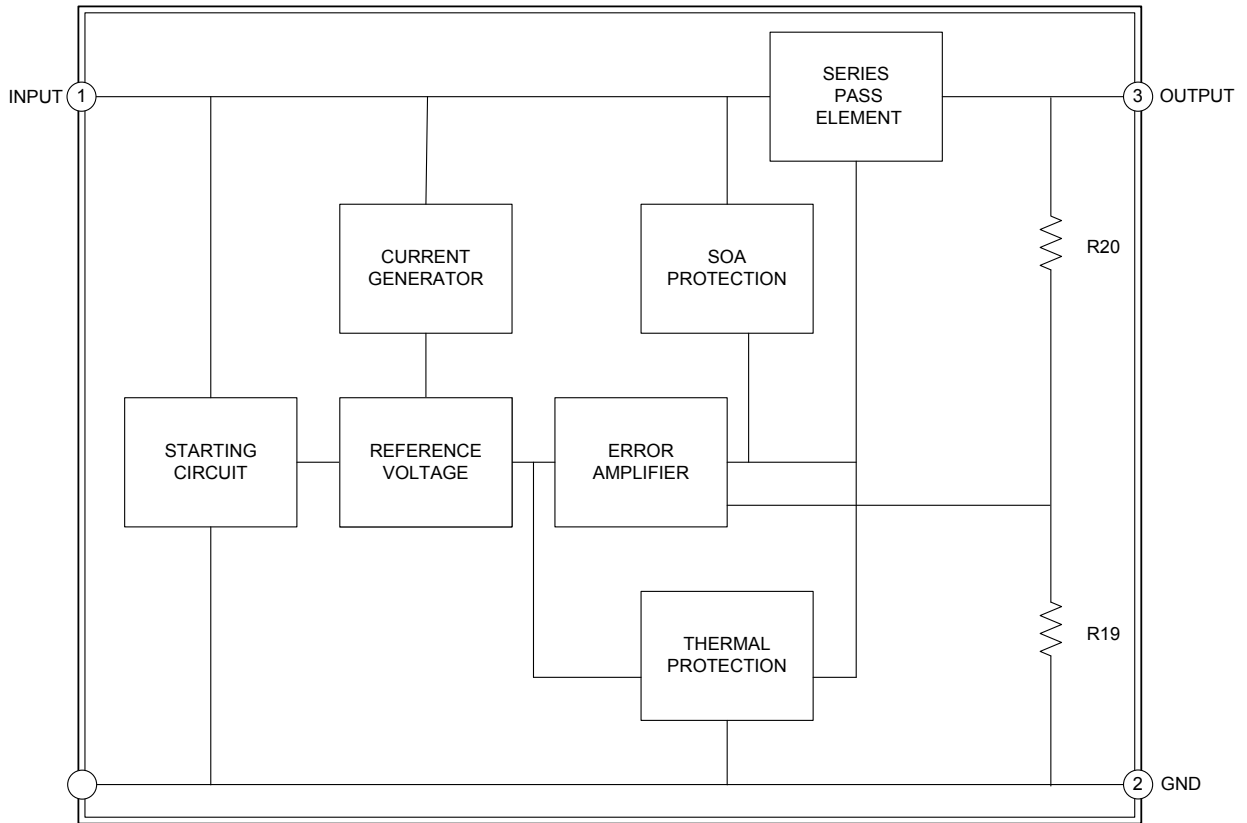

■ ABSOLUTE MAXIMUM RATINGS

(Operating temperature range applies unless otherwise specified)

PARAMETER	SYMBOL	RATING	UNIT
Input Voltage	$V_{OUT}=5\sim 18V$	35	V
	$V_{OUT}=24V$	40	V
Output Current	I_{OUT}	0.5	A
Power Dissipation	P_D	Internally Limited	W
Operating Junction Temperature Range	T_{OPR}	-20 ~ +125	°C
Storage Temperature Range	T_{STG}	-65 ~ +150	°C

Note: Absolute maximum ratings are those values beyond which the device could be permanently damaged. Absolute maximum ratings are stress ratings only and functional device operation is not implied.

■ ELECTRICAL CHARACTERISTICS

FOR UTC78M05

(Refer to the test circuits, $T_{MIN}\leq T_J\leq 125^\circ C$, $I_{OUT}=350mA$, $V_{IN}=10V$, unless otherwise specified, $C_i=0.33\mu F$, $C_o=0.1\mu F$)

PARAMETER	SYMBOL	TEST CONDITIONS	MIN	TYP	MAX	UNIT
Output Voltage	V_{OUT}	$T_J=25^\circ C$	4.80	5.0	5.20	V
		$I_{OUT}=5mA \sim 350mA$ $V_{IN}=7\sim 20V$	4.75		5.25	V
Load Regulation	ΔV_{OUT}	$T_J=25^\circ C$, $I_{OUT}=5mA\sim 0.5A$			100	mV
		$T_J=25^\circ C$, $I_{OUT}=5mA\sim 200mA$			50	mV
Line regulation	ΔV_{OUT}	$V_{IN}=7\sim 25V$, $T_J=25^\circ C$, $I_{OUT}=200mA$			100	mV
		$V_{IN}=8\sim 25V$, $T_J=25^\circ C$, $I_{OUT}=200mA$			50	mV
Quiescent Current	I_Q	$T_J=25^\circ C$		4.0	6.0	mA
Quiescent Current Change	ΔI_Q	$V_{IN}=8\sim 25V$, $I_{OUT}=200mA$			0.8	mA
		$I_{OUT}=5mA\sim 350mA$			0.5	mA
Output Noise Voltage	eN	$10Hz\leq f\leq 100KHz$		40		μV
Ripple Rejection	RR	$V_{IN}=8\sim 18V$, $f=120Hz$ $I_{OUT}=300mA$	62			dB
Peak Output Current	I_{PEAK}	$T_J=25^\circ C$		700		mA
Short-Circuit Current	I_{SC}	$V_{IN}=35V$, $T_J=25^\circ C$		300		mA
Dropout Voltage	V_D	$T_J=25^\circ C$, $I_{OUT}=500mA$		2.0		V

FOR UTC78M06

(Refer to the test circuits, $T_{MIN}\leq T_J\leq 125^\circ C$, $I_{OUT}=350mA$, $V_{IN}=11V$, unless otherwise specified, $C_i=0.33\mu F$, $C_o=0.1\mu F$)

PARAMETER	SYMBOL	TEST CONDITIONS	MIN	TYP	MAX	UNIT
Output Voltage	V_{OUT}	$T_J=25^\circ C$, $I_{OUT}=5\sim 350mA$	5.76	6.0	6.24	V
		$V_{IN}=8\sim 21V$, $I_{OUT}=5mA\sim 350mA$	5.70		6.30	V
Load Regulation	ΔV_{OUT}	$T_J=25^\circ C$, $I_{OUT}=5mA\sim 0.5A$			120	mV
		$T_J=25^\circ C$, $I_{OUT}=5mA\sim 200mA$			60	mV
Line regulation	ΔV_{OUT}	$V_{IN}=8V\sim 25V$, $T_J=25^\circ C$, $I_{OUT}=200mA$			100	mV
		$V_{IN}=9V\sim 25V$, $T_J=25^\circ C$, $I_{OUT}=200mA$			50	mV
Quiescent Current	I_Q	$T_J=25^\circ C$		4.0	6	mA
Quiescent Current Change	ΔI_Q	$I_{OUT}=5mA\sim 350mA$			0.5	mA
		$V_{IN}=9V\sim 25V$, $I_{OUT}=200mA$			0.8	mA
Output Noise Voltage	eN	$10Hz\leq f\leq 100kHz$		45		μV
Ripple Rejection	RR	$V_{IN}=9V\sim 19V$, $f=120Hz$, $T_J=25^\circ C$ $I_{OUT}=300mA$	59			dB
Peak Output Current	I_{PEAK}	$T_J=25^\circ C$		700		mA
Short-Circuit Current	I_{SC}	$V_{IN}=35V$, $T_J=25^\circ C$		300		mA
Dropout Voltage	V_D	$T_J=25^\circ C$		2.0		V

■ ELECTRICAL CHARACTERISTICS (Cont.)

FOR UTC78M08

(Refer to the test circuits, $T_{MIN} \leq T_J \leq 125^\circ\text{C}$, $I_{OUT} = 350\text{mA}$, $V_{IN} = 14\text{V}$, unless otherwise specified, $C_i = 0.33\mu\text{F}$, $C_o = 0.1\mu\text{F}$)

PARAMETER	SYMBOL	TEST CONDITIONS	MIN	TYP	MAX	UNIT
Output Voltage	V_{OUT}	$T_J = 25^\circ\text{C}$	7.68	8.0	8.32	V
		$V_{IN} = 10.5\text{V} \sim 23\text{V}$, $I_{OUT} = 5\text{mA} \sim 350\text{mA}$	7.60		8.40	V
Load Regulation	ΔV_{OUT}	$T_J = 25^\circ\text{C}$, $I_{OUT} = 5\text{mA} \sim 0.5\text{A}$			160	mV
		$T_J = 25^\circ\text{C}$, $I_{OUT} = 5\text{mA} \sim 200\text{mA}$			80	mV
Line regulation	ΔV_{OUT}	$V_{IN} = 10.5\text{V} \sim 25\text{V}$ $T_J = 25^\circ\text{C}$, $I_{OUT} = 200\text{mA}$			100	mV
		$V_{IN} = 11\text{V} \sim 25\text{V}$ $T_J = 25^\circ\text{C}$, $I_{OUT} = 200\text{mA}$			50	mV
Quiescent Current	I_Q	$T_J = 25^\circ\text{C}$		4.0	6	mA
Quiescent Current Change	ΔI_Q	$V_{IN} = 10.5\text{V} \sim 25\text{V}$, $I_{OUT} = 200\text{mA}$			0.8	mA
		$I_{OUT} = 5\text{mA} \sim 350\text{mA}$			0.5	mA
Output Noise Voltage	eN	$10\text{Hz} \leq f \leq 100\text{KHz}$		52		μV
Ripple Rejection	RR	$V_{IN} = 11.5\text{V} \sim 21.5\text{V}$, $f = 120\text{Hz}$, $I_{OUT} = 300\text{mA}$	56			dB
Peak Output Current	I_{PEAK}	$T_J = 25^\circ\text{C}$		700		mA
Short-Circuit Current	I_{SC}	$V_{IN} = 35\text{V}$, $T_J = 25^\circ\text{C}$		300		mA
Dropout Voltage	V_D	$T_J = 25^\circ\text{C}$, $I_{OUT} = 500\text{mA}$		2.0		V

FOR UTC78M09

(Refer to the test circuits, $T_{MIN} \leq T_J \leq 125^\circ\text{C}$, $I_{OUT} = 350\text{mA}$, $V_{IN} = 17\text{V}$, unless otherwise specified, $C_i = 0.33\mu\text{F}$, $C_o = 0.1\mu\text{F}$)

PARAMETER	SYMBOL	TEST CONDITIONS	MIN	TYP	MAX	UNIT
Output Voltage	V_{OUT}	$T_J = 25^\circ\text{C}$	8.64	9	9.36	V
		$V_{IN} = 12.5\text{V} \sim 25\text{V}$, $I_{OUT} = 5\text{mA} \sim 350\text{mA}$	8.55		9.45	V
Load Regulation	ΔV_{OUT}	$T_J = 25^\circ\text{C}$, $I_{OUT} = 5\text{mA} \sim 0.5\text{A}$			200	mV
		$T_J = 25^\circ\text{C}$, $I_{OUT} = 5\text{mA} \sim 200\text{mA}$			100	mV
Line regulation	ΔV_{OUT}	$V_{IN} = 12.5\text{V} \sim 25\text{V}$ $T_J = 25^\circ\text{C}$, $I_{OUT} = 200\text{mA}$			100	mV
		$V_{IN} = 13\text{V} \sim 25\text{V}$ $T_J = 25^\circ\text{C}$, $I_{OUT} = 200\text{mA}$			50	mV
Quiescent Current	I_Q	$T_J = 25^\circ\text{C}$		4.1	6	mA
Quiescent Current Change	ΔI_Q	$V_{IN} = 12.5\text{V} \sim 25\text{V}$, $I_{OUT} = 200\text{mA}$			0.8	mA
		$I_{OUT} = 5\text{mA} \sim 350\text{mA}$			0.5	mA
Output Noise Voltage	eN	$10\text{Hz} \leq f \leq 100\text{kHz}$		65		μV
Ripple Rejection	RR	$V_{IN} = 13\text{V} \sim 23\text{V}$, $f = 120\text{Hz}$ $I_{OUT} = 300\text{mA}$	55			dB
Peak Output Current	I_{PEAK}	$T_J = 25^\circ\text{C}$		700		mA
Short-Circuit Current	I_{SC}	$V_{IN} = 35\text{V}$, $T_J = 25^\circ\text{C}$		300		mA
Dropout Voltage	V_D	$T_J = 25^\circ\text{C}$, $I_{OUT} = 500\text{mA}$		2.0		V

■ ELECTRICAL CHARACTERISTICS (Cont.)

FOR UTC78M12

(Refer to the test circuits, $T_{MIN} \leq T_J \leq 125^\circ\text{C}$, $I_{OUT} = 350\text{mA}$, $V_{IN} = 19\text{V}$, unless otherwise specified, $C_i = 0.33\mu\text{F}$, $C_o = 0.1\mu\text{F}$)

PARAMETER	SYMBOL	TEST CONDITIONS	MIN	TYP	MAX	UNIT
Output Voltage	V_{OUT}	$T_J = 25^\circ\text{C}$	11.52	12.0	12.48	V
		$V_{IN} = 14.5\text{V to } 27\text{V}$, $I_{OUT} = 5\text{mA} \sim 350\text{mA}$	11.40		12.60	V
Load Regulation	ΔV_{OUT}	$T_J = 25^\circ\text{C}$, $I_{OUT} = 5\text{mA} \sim 0.5\text{A}$			240	mV
		$T_J = 25^\circ\text{C}$, $I_{OUT} = 5\text{mA} \sim 2\text{A}$			120	mV
Line regulation	ΔV_{OUT}	$V_{IN} = 14.5\text{V to } 30\text{V}$ $T_J = 25^\circ\text{C}$, $I_{OUT} = 200\text{mA}$			100	mV
		$V_{IN} = 16\text{V to } 30\text{V}$ $T_J = 25^\circ\text{C}$, $I_{OUT} = 200\text{mA}$			50	mV
Quiescent Current	I_Q	$T_J = 25^\circ\text{C}$		4.1	6.0	mA
Quiescent Current Change	ΔI_Q	$V_{IN} = 14.5\text{V to } 30\text{V}$, $I_{OUT} = 200\text{mA}$			0.8	mA
		$I_{OUT} = 5\text{mA} \sim 350\text{mA}$			0.5	mA
Output Noise Voltage	eN	$10\text{Hz} \leq f \leq 100\text{kHz}$		75		μV
Ripple Rejection	RR	$V_{IN} = 15\text{V to } 25\text{V}$, $f = 120\text{Hz}$ $I_{OUT} = 300\text{mA}$	55			dB
Peak Output Current	I_{PEAK}	$T_J = 25^\circ\text{C}$		700		mA
Short-Circuit Current	I_{SC}	$V_{IN} = 35\text{V}$, $T_J = 25^\circ\text{C}$		300		mA
Dropout Voltage	V_D	$T_J = 25^\circ\text{C}$, $I_{OUT} = 500\text{mA}$		2.0		V

FOR UTC78M15

(Refer to the test circuits, $T_{MIN} \leq T_J \leq 125^\circ\text{C}$, $I_{OUT} = 350\text{mA}$, $V_{IN} = 23\text{V}$, unless otherwise specified, $C_i = 0.33\mu\text{F}$, $C_o = 0.1\mu\text{F}$)

PARAMETER	SYMBOL	TEST CONDITIONS	MIN	TYP	MAX	UNIT
Output Voltage	V_{OUT}	$T_J = 25^\circ\text{C}$	14.40	15.0	15.60	V
		$V_{IN} = 17.5\text{V} \sim 30\text{V}$, $I_{OUT} = 5\text{mA} \sim 350\text{mA}$	14.25		15.75	V
Load Regulation	ΔV_{OUT}	$T_J = 25^\circ\text{C}$, $I_{OUT} = 5\text{mA} \sim 0.5\text{A}$			300	mV
		$T_J = 25^\circ\text{C}$, $I_{OUT} = 5\text{mA} \sim 200\text{mA}$			150	mV
Line regulation	ΔV_{OUT}	$V_{IN} = 17.5\text{V} \sim 30\text{V}$ $T_J = 25^\circ\text{C}$, $I_{OUT} = 200\text{mA}$			100	mV
		$V_{IN} = 20\text{V} \sim 30\text{V}$ $T_J = 25^\circ\text{C}$, $I_{OUT} = 200\text{mA}$			50	mV
Quiescent Current	I_Q	$T_J = 25^\circ\text{C}$		4.1	6.0	mA
Quiescent Current Change	ΔI_Q	$V_{IN} = 17.5\text{V} \sim 30\text{V}$, $I_{OUT} = 200\text{mA}$			0.8	mA
		$I_{OUT} = 5\text{mA} \sim 350\text{mA}$			0.5	mA
Output Noise Voltage	eN	$10\text{Hz} \leq f \leq 100\text{KHz}$		90		μV
Ripple Rejection	RR	$V_{IN} = 18.5\text{V} \sim 28.5\text{V}$ $f = 120\text{Hz}$, $I_{OUT} = 300\text{mA}$	54			dB
Peak Output Current	I_{PEAK}	$T_J = 25^\circ\text{C}$		700		mA
Short-Circuit Current	I_{SC}	$V_{IN} = 35\text{V}$, $T_J = 25^\circ\text{C}$		300		mA
Dropout Voltage	V_D	$T_J = 25^\circ\text{C}$, $I_{OUT} = 500\text{mA}$		2.0		V

■ ELECTRICAL CHARACTERISTICS (Cont.)

FOR 78M18

(Refer to the test circuits, $T_{MIN} \leq T_J \leq 125^\circ\text{C}$, $I_{OUT}=350\text{mA}$, $V_{IN}=26\text{V}$, unless otherwise specified, $C_i=0.33\mu\text{F}$, $C_o=0.1\mu\text{F}$)

PARAMETER	SYMBOL	TEST CONDITIONS	MIN	TYP	MAX	UNIT
Output Voltage	V_{OUT}	$T_J = 25^\circ\text{C}$	17.28	18.0	18.72	V
		$V_{IN} = 20.5\text{V to } 33\text{V}$ $I_{OUT} = 5\text{mA} \sim 350\text{mA}$	17.10		18.90	V
Load Regulation	ΔV_{OUT}	$T_J = 25^\circ\text{C}, I_{OUT} = 5\text{mA} \sim 0.5\text{A}$			360	mV
		$T_J = 25^\circ\text{C}, I_{OUT} = 5\text{mA} \sim 200\text{mA}$			180	mV
Line regulation	ΔV_{OUT}	$V_{IN} = 21\text{V to } 33\text{V}$ $T_J = 25^\circ\text{C}, I_{OUT} = 200\text{mA}$			100	mV
		$V_{IN} = 24\text{V to } 33\text{V}$, $T_J = 25^\circ\text{C}, I_{OUT} = 200\text{mA}$			50	mV
Quiescent Current	I_Q	$T_J = 25^\circ\text{C}$		4.2	6	mA
Quiescent Current Change	ΔI_Q	$V_{IN} = 21\text{V to } 33\text{V}, I_{OUT} = 200\text{mA}$			0.8	mA
		$I_{OUT} = 5\text{mA} \sim 350\text{mA}$			0.5	mA
Output Noise Voltage	eN	$10\text{Hz} \leq f \leq 100\text{KHz}$		100		μV
Ripple Rejection	RR	$V_{IN} = 22\text{V to } 32\text{V}, f = 120\text{Hz}$ $I_{OUT} = 300\text{mA}$	53			dB
Peak Output Current	I_{PEAK}	$T_J = 25^\circ\text{C}$		700		mA
Short-Circuit Current	I_{SC}	$V_{IN} = 35\text{V}, T_J = 25^\circ\text{C}$		300		mA
Dropout Voltage	V_D	$T_J = 25^\circ\text{C}$		2.0		V

FOR 78M24

(Refer to the test circuits, $T_{MIN} \leq T_J \leq 125^\circ\text{C}$, $I_{OUT}=350\text{mA}$, $V_{IN}=33\text{V}$, unless otherwise specified, $C_i=0.33\mu\text{F}$, $C_o=0.1\mu\text{F}$)

PARAMETER	SYMBOL	TEST CONDITIONS	MIN	TYP	MAX	UNIT
Output Voltage	V_{OUT}	$T_J = 25^\circ\text{C}$	23.04	24.0	24.96	V
		$V_{IN} = 27\text{V to } 38\text{V}$ $I_{OUT} = 5\text{mA} \sim 350\text{mA}$	22.80		25.20	V
Load Regulation	ΔV_{OUT}	$T_J = 25^\circ\text{C}, I_{OUT} = 5\text{mA} \sim 0.5\text{A}$			480	mV
		$T_J = 25^\circ\text{C}, I_{OUT} = 5\text{mA} \sim 200\text{mA}$			240	mV
Line regulation	ΔV_{OUT}	$V_{IN} = 27\text{V to } 38\text{V}$ $T_J = 25^\circ\text{C}, I_{OUT} = 200\text{mA}$			100	mV
		$V_{IN} = 28\text{V to } 38\text{V}$ $T_J = 25^\circ\text{C}, I_{OUT} = 200\text{mA}$			50	mV
Quiescent Current	I_Q	$T_J = 25^\circ\text{C}$,		4.2	6.0	mA
Quiescent Current Change	ΔI_Q	$V_{IN} = 27\text{V to } 38\text{V}, I_{OUT} = 200\text{mA}$			0.8	mA
		$I_{OUT} = 5\text{mA} \sim 350\text{mA}$			0.5	mA
Output Noise Voltage	eN	$10\text{Hz} \leq f \leq 100\text{KHz}$		170		μV
Ripple Rejection	RR	$V_{IN} = 28\text{V to } 38\text{V}, f = 120\text{Hz}$ $I_{OUT} = 300\text{mA}$	50			dB
Peak Output Current	I_{PEAK}	$T_J = 25^\circ\text{C}$		700		mA
Short-Circuit Current	I_{SC}	$V_{IN} = 35\text{V}, T_J = 25^\circ\text{C}$		300		mA
Dropout Voltage	V_D	$T_J = 25^\circ\text{C}$		2.0		V

Notes 1. The Maximum steady state usable output current is dependent on input voltage, heat sinking, lead length of the package and copper pattern of PCB. The data above represents pulse test conditions with junction temperatures specified at the initiation of test.

2. Power dissipation $< 0.5\text{W}$

■ APPLICATION CIRCUIT

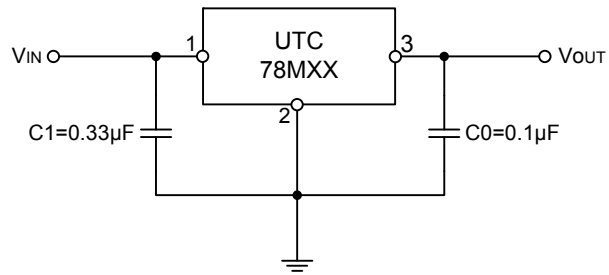

- Notes: 1. To specify an output voltage, substitute voltage value for "MXX".
2. Bypass capacitors are recommended for optimum stability and transient response and should be located as close as possible to the regulators.

TYPICAL CHARACTERISTICS

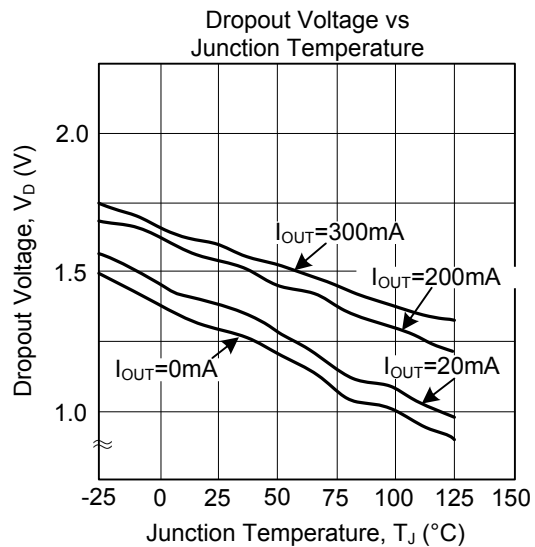
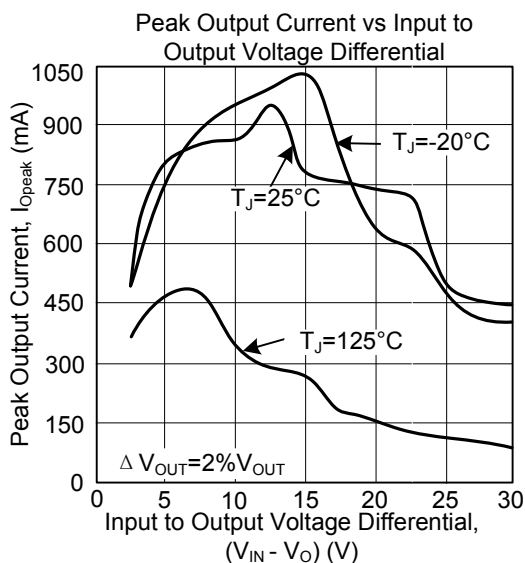
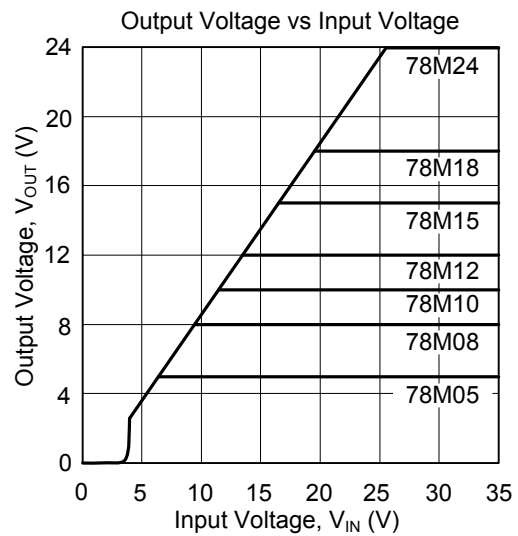
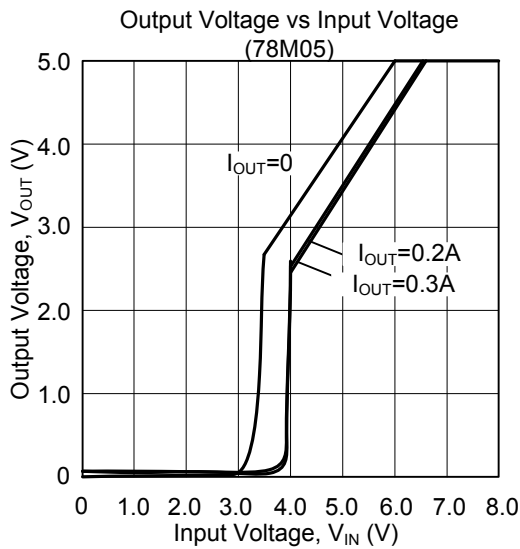
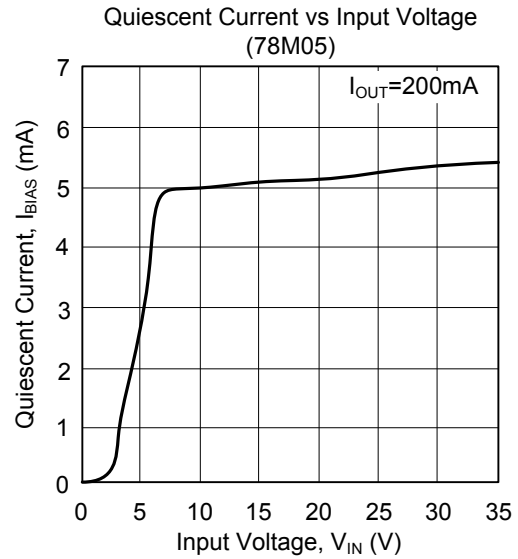
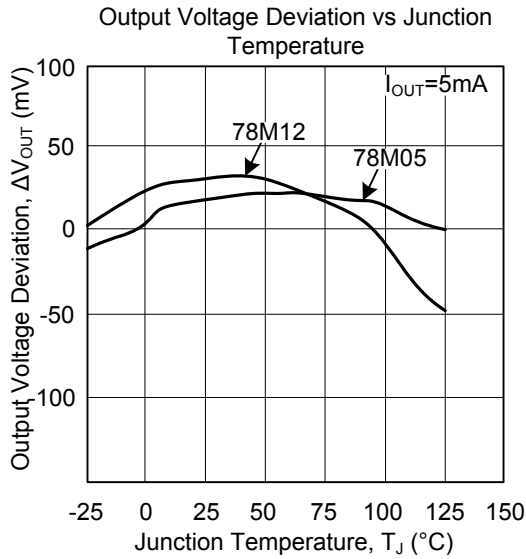

■ TYPICAL CHARACTERISTICS(Cont.)

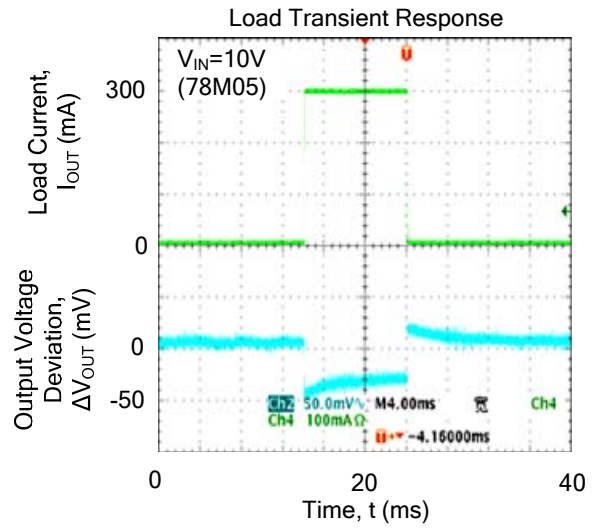
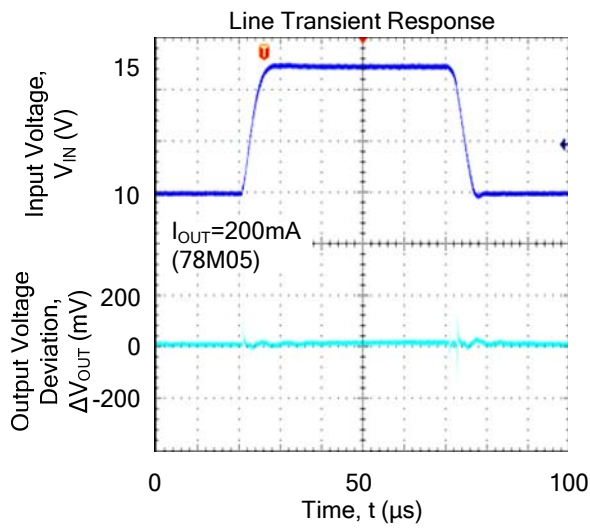

UTC assumes no responsibility for equipment failures that result from using products at values that exceed, even momentarily, rated values (such as maximum ratings, operating condition ranges, or other parameters) listed in products specifications of any and all UTC products described or contained herein. UTC products are not designed for use in life support appliances, devices or systems where malfunction of these products can be reasonably expected to result in personal injury. Reproduction in whole or in part is prohibited without the prior written consent of the copyright owner. The information presented in this document does not form part of any quotation or contract, is believed to be accurate and reliable and may be changed without notice.