

MITSUBISHI ICs (TV)
M51408SP

PAL/NTSC SYSTEM SINGLE-CHIP COLOR TV SIGNAL PROCESSOR

DESCRIPTION

The M51408SP is a single-chip semiconductor integrated circuit with signal processing capabilities compatible with both PAL and NTSC type color televisions.

It features a variety of signal processing functions including video IF, sound IF, picture, color, and deflection signal processing. It also combines tuner and simple transistor output level to facilitate practical PAL / NTSC type color television set design.

PAL / NTSC / SECAM multi-system can be constructed by adding an IC for processing SECAM chroma signals.

FEATURES

- With the exception of tuner and output level, all color television signal processing functions are built-in, enhancing practicality and reliability of the television set itself while contributing to lower power dissipation.
- The intermediate frequency input pins consist of two pins for actuation input and feature high stability toward oscillation.
- Horizontal oscillation can be counted down from 32 times the horizontal frequency using a ceramic oscillator, and requires no adjustment of free run frequency.
- Vertical oscillation can be counted down from 2 times the horizontal frequency produced by horizontal count-down and requires no vertical sync volume. Because count-down is used, the number of external components required for the vertical circuit is minimized.
- Enables use of AFT defeat, picture muting, and sound muting.
- Features direct current control for picture quality, contrast, luminance, color saturation, and volume.
- A multi-system can be constructed by adding a SECAM chroma IC.
 (M51397AP, M52026SP)

APPLICATION

PAL / NTSC / SECAM Multi-System Color TV

RECOMMENDED OPERATING CONDITION

Supply Voltage Range	8.5~9.5V (V ₁₀ , V ₁₉)
Rated Supply Voltage	9.0V (V ₁₀ , V ₁₉)
Current Range	15~22mA (I ₋₁)
Rated Current	18mA (I ₋₁)

PIN CONFIGURATION (TOP VIEW)

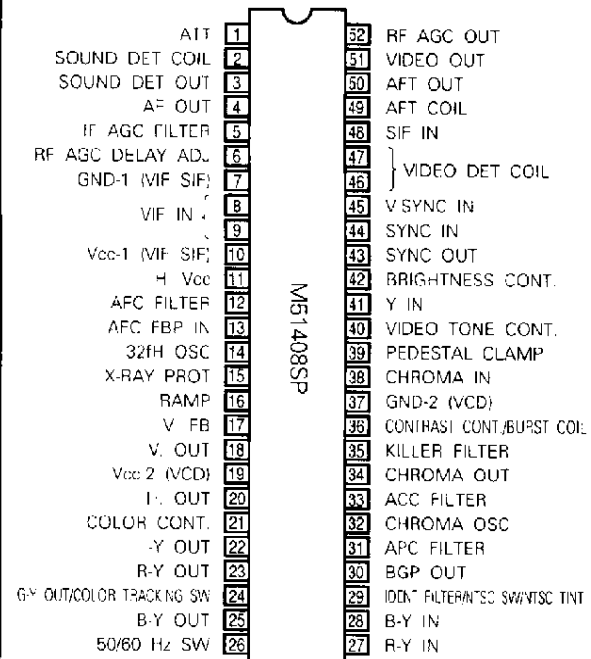

Outline 52P4B

M51408SP

PAL/NTSC SYSTEM SINGLE-CHIP COLOR TV SIGNAL PROCESSOR

BLOCK DIAGRAM

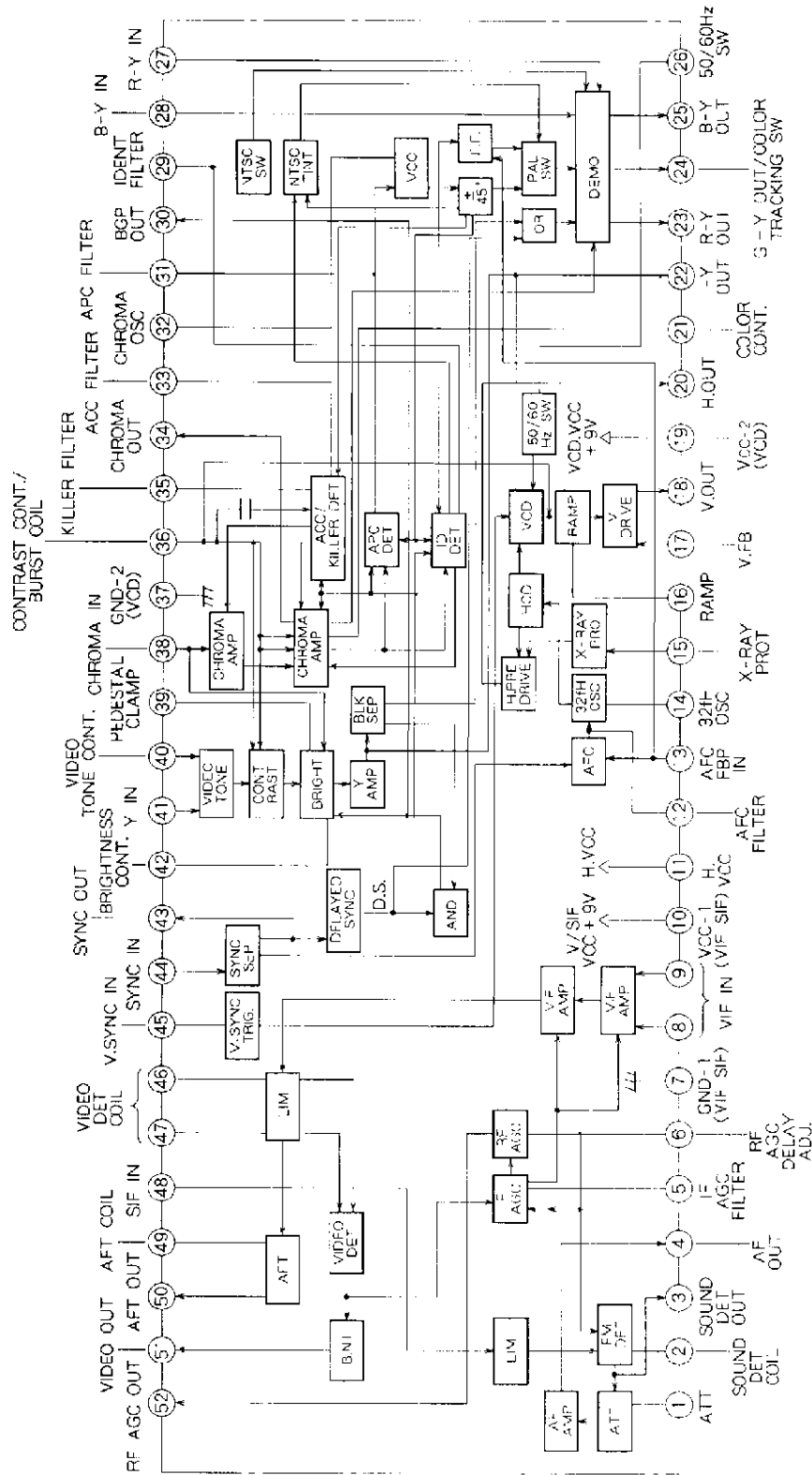

M51408SP

PAL/NTSC SYSTEM SINGLE-CHIP COLOR TV SIGNAL PROCESSOR

ABSOLUTE MAXIMUM RATINGS

Symbol	Parameter	Ratings	Unit
V _{CC}	Supply voltage	10.8	V
P _d	Power dissipation	1.4	W
T _{opr}	Operating temperature	-20~65	°C
T _{stg}	Storage temperature	-40~125	°C

ELECTRICAL CHARACTERISTICS (T_a = 25°C, unless otherwise noted)

VIF/SIF SECTION

Symbol	Parameter	Test point	Input ()	Test conditions *																Limits			Unit				
				1	5	6	V _{CC} , 10	S 2	S 5	S 6	S 6A	S 10	S 10A	S 47	S 48	S 48A	S 49	S 51	S 57	S 52A	Note	Min.		Typ.	Max.		
I _{CC0}	Circuit current	A10	-	-	-	-	9.0V	-	-	○	-	○	-	-	-	-	-	-	-	-	-	-	-	27	36	50	mA
V ₅₁	Video output direct current voltage	51	-	-	-	-	9.0V	○	○	○	-	○	-	-	-	-	-	-	-	-	-	-	-	4.55	4.9	5.35	V
V ₀₅₁	Video output signal voltage	51	A SG1	-	-	-	9.0V	○	-	○	-	○	-	-	-	-	-	-	-	-	-	-	-	1.7	2.0	2.3	V _{P-P}
V ₅₁₁	Sync signal tip voltage	51	A SG2	-	-	-	9.0V	○	-	○	-	○	-	-	-	-	-	-	-	-	-	-	-	2.3	2.6	2.9	V
V _{in min}	Input sensitivity	51A	A SG3	-	-	-	9.0V	○	-	○	-	○	-	-	-	-	-	-	-	-	-	-	1	37	45	51	dB μ
V _{in max}	Maximum allowable input	51A	A SG4	-	-	-	9.0V	○	-	○	-	○	-	-	-	-	-	-	-	-	-	-	2	103	110		dB μ
V _{ATH}	Black spot noise inverter	51	A SG2 SG5	-	-	-	9.0V	○	-	○	-	○	-	-	-	-	-	-	-	-	-	-	3	1.7	2.0	2.3	V
V _{BCL}																								3.3	3.8	4.3	V
BW	Video frequency characteristics	51	A SG8	-	-	-	9.0V	○	-	○	-	○	-	-	-	-	-	-	-	-	-	-	4	5.6	8		MHz
IM	Intermodulation	51	A SG9	-	-	-	9.0V	○	-	○	-	○	-	-	-	-	-	-	-	-	-	-	5	32	45		dB
S/N	Video noise	51A	A SG2	-	-	-	9.0V	○	-	○	-	○	-	-	-	-	-	-	-	-	-	-	6	50	56		dB
V ₅₀	AFT output direct current	50	-	-	-	-	9.0V	○	○	○	-	○	-	-	-	-	-	-	-	-	-	-	-	3.0	4.0	5.0	V
V _{50H}	AFT output maximum voltage	50	A SG6	-	-	-	9.0V	○	-	○	-	○	-	-	-	-	-	-	-	-	-	-	7	8.0	8.7		V
V _{50L}	AFT Output minimum voltage	50	A SG7	-	-	-	9.0V	○	-	○	-	○	-	-	-	-	-	-	-	-	-	-	8		0.3	1.0	V
μAFT	AFT sensitivity	50	A SG5	-	-	-	9.0V	○	-	○	-	○	-	-	-	-	-	-	-	-	-	-	9	40	60	120	mV/kHz
V ₅₀₀	AFT defeat voltage	50	A SG5	-	-	-	9.0V	○	-	○	-	○	-	-	-	-	-	-	-	-	-	-	-	4.35	4.5	4.65	V
V _{52H}	RF AGC maximum voltage	52	A SG11	-	-	2.5V	9.0V	○	-	○	-	○	-	-	-	-	-	-	-	-	-	-	-	7.0	8.0		V
V _{52L}	RF AGC minimum voltage	52	A SG10	-	-	2.5V	9.0V	○	-	○	-	○	-	-	-	-	-	-	-	-	-	-	-		0.01	0.3	V
V. S. MUTE1	Sync mute starting voltage	5 6	-	9.0V	M	9.0V	-	-	-	○	-	○	-	-	-	-	-	-	-	-	-	-	10		0.7	1.2	V
V ₃	AF direct output direct current voltage	3	-	-	-	-	9.0V	-	○	○	-	○	-	-	-	-	-	-	-	-	-	-	-	3.4	3.9	4.5	V
V _{0AF}	AF direct output signal voltage	3	C SG12	-	-	-	9.0V	-	○	○	-	○	-	-	-	-	-	-	-	-	-	-	-	540	630	720	mVrms

* : - Indicates open.



M51408SP

PAL/NTSC SYSTEM SINGLE-CHIP COLOR TV SIGNAL PROCESSOR

VIF/SIF SECTION (cont.)

Symbol	Parameter	Test point	Input ()	Test conditions *																Limits			Unit	
				1	5	6	V _{CC} 10	S 2	S 5	S 6	S 6A	S 10	S 10 A	S 47	S 48	S 49	S 51	S 52	S 52 A	N o	Min.	Typ.		Max.
LIM	Limiting sensitivity	3	C SG14	-	-	-	9.0V	-	○	○	-	○	-	-	○	○	-	○	-	11		42	50	dB μ
AMR	AMR	3	C SG15	-	-	-	9.0V	-	○	○	-	○	-	-	○	○	-	○	-	12	50	60		dB
V _{O4}	AF Driver output	4	C SG12	-	-	-	9.0V	-	○	○	-	○	-	-	○	○	-	○	-		250	460	650	mVrms
V _{O4} max	AF Driver maximum output	4	C SG12	9.0V	-	-	9.0V	-	○	○	-	○	-	-	○	○	-	○	-		700	930	1200	mVrms
ATT	Maximum attenuation	4	C SG12	9.0V	-	-	9.0V	-	○	○	-	○	-	-	○	○	-	○	-	13	70	80		dB
GAF	AF Driver gain																			14	2.1	4.3	5.2	dB
S/N AF	Sound S/N	4	C SG16	9.0V	-	-	9.0V	-	○	○	-	○	-	-	○	○	-	○	-	15	55	66		dB
S MUTE	Sound muting voltage	2	C SG12	9.0V	-	-	9.0V	○	○	○	-	○	-	-	○	○	-	○	-			0.4	1.0	mVrms
V.S. MUTE2	Video sound muting sound output	4	C SG12	9.0V	-	-	9.0V	-	-	-	○	-	-	○	○	-	○	-			0.3	1.0	V	
THD AF	AF Driver maximum output distortion	4	C SG12	9.0V	-	-	9.0V	○	○	○	-	○	-	-	○	○	-	○	-			1	5	%
V ₁	Pin ① voltage	1	-	H	-	-	9.0V	-	○	○	-	○	-	-	○	○	-	○	-		4.8	5.3	5.8	V

* : - Indicates open

SYNC SECTION (Horizontal)

Symbol	Parameter	Test point	Input ()	Test conditions *																Limits			Unit	
				11	11 A	15	16 A	17	19	S 11 A	S 11 B	S 12 A	S 13	S 16	S 17	S 19	S 20	S 22	S 36	S 44 A	S 44 B	N o		Min.
I _{SS}	Sync separation input sensitivity current	I _{SS} 43	I _{SS} Variable	-	-	-	9.0V	-	-	-	-	-	○	-	-	-	-	○	-	16	0.05	0.1	0.2	mA
V _{43H}	Sync separation output maximum voltage	43	D SG17	-	-	-	9.0V	-	-	-	-	-	○	-	-	-	-	○	-	17	8.0	8.9		V _{O-P}
V _{43L}	Sync separation output minimum voltage	43	D SG17	-	-	-	9.0V	-	-	-	-	-	○	-	-	-	-	○	-	18	2.5	3.0	3.5	V _{O-P}
T _{BGP-}	B. G. P. Timing	D 30	D SG18	-	-	-	9.0V	-	-	-	-	-	○	-	-	-	-	○	-	19	0	1	2	μs
T _{BGP-1}																						2.5	3.5	5.0
V _{BGP-H}	B. G. P. Amplitude	30	D SG18	-	-	-	9.0V	-	-	-	-	-	○	-	-	-	-	○	-	20	5.4	6.2	7.0	V _{O-P}
V _{BGP-L}																							0	0.3
I _{CC 11}	H. Vcc current	A11	-	-	12.0V	-	-	-	○	○	○	-	-	-	-	-	-	-	-		12.0	16.0	20.0	mA
f _H	Horizontal free run frequency	20	-	-	12.0V	-	-	○	-	○	○	-	-	-	-	-	-	-	-		15.20	15.625	15.95	kHz
V _{11 min}	Horizontal oscillator starting voltage	11 20	-	-	0V	-	-	○	-	○	○	-	-	-	-	-	-	-	-	21		4.5	5.4	V
f _{PHI}	Horizontal pull-in range	D20	D SG18 f Variable	9.0V	9.0V	0V	-	9.0V	○	-	○	○	-	-	○	○	-	○	-	22	-500	-600		Hz
f _{PHL}																						+500	+600	
V _{2CH}	Horizontal output maximum voltage	20	D SG18	9.0V	9.0V	0V	-	9.0V	○	-	○	○	-	-	○	○	-	○	-	23	3.2	3.8		V _{O-P}

* : - Indicates open

M51408SP

PAL/NTSC SYSTEM SINGLE-CHIP COLOR TV SIGNAL PROCESSOR

SYNC SECTION (Horizontal) (cont.)

Symbol	Parameter	Test point	Input ()	Test conditions *																								Limits			Unit	
				11	11A	15	16A	17	19	S11	S11A	S11B	S12	S12A	S13	S16	S17	S19	S20	S22	S36	S44	S44A	S25 Note	Min.	Typ.	Max.					
V20I	Horizontal output minimum voltage	20	D SG18	9.0V	9.0V	0V	-	-	9.0V	0	-	0	0	0	-	0	0	-	0	0	-	0	0	-	0	0	-	24		0	0.3	V _{O-P}
T _H	Horizontal output pulse width	20	D SG18	9.0V	9.0V	0V	-	-	9.0V	0	-	0	0	0	-	0	0	-	0	0	-	0	0	-	0	0	-	25	22	24	26	μs
V20H (6V)	Pin ⑩ = 6v horizontal output maximum voltage	20	-	6.0V	-	C	-	-	0	-	0	0	-	-	-	-	-	-	-	-	-	-	-	-	-	-	-	1.2	1.8	2.4	V _{O-P}	
f _H (VCC)	Free run frequency Increase/ Decrease power supply voltage	20	-	9V	15V	C	-	-	0	-	0	0	-	-	-	-	-	-	-	-	-	-	-	-	-	-	15.20	15.625	15.95	kHz		
V _{PRO}	Overvoltage detection operating voltage	15 20	-	9.0V	-	V ₁₅ variable	-	-	0	-	0	0	-	-	-	-	-	-	-	-	-	-	-	-	-	-	0.63	0.73	0.83	V		

* : - Indicates open.

SYNC SECTION (Vertical)

Symbol	Parameter	Test point	Input ()	Test conditions *																								Limits			Unit
				11	11A	15	16A	17	19	36	S11	S11A	S11B	S12	S12A	S13	S16	S17	S19	S20	S22	S36	S44	S44A	S25 Note	Min.	Typ.	Max.			
f _{V50}	Vertical free run frequency 50Hz	16	D SG18	9.0V	9.0V	0V	0V	-	9.0V	4.5V	0	-	0	0	0	-	0	0	-	0	0	-	0	0	-	0	0	43.4	44.4	45.4	Hz
f _{V50}	Vertical pull-in frequency (50Hz)	16	0 SG20 variable	9.0V	9.0V	0V	0V	-	9.0V	4.5V	0	-	0	0	0	-	0	0	-	0	0	-	0	0	-	0	0	27	55.6	56.6	Hz
T _{V50}	Vertical output pulse width(50Hz)	16	D SG17	9.0V	9.0V	0V	0V	-	9.0V	4.5V	0	-	0	0	0	-	0	0	-	0	0	-	0	0	-	0	0	494	544	594	μs
V _{18H}	Vertical output maximum voltage	18	D SG17	9.0V	9.0V	0V	0V	-	3.7V	9.0V	4.5V	0	-	0	0	0	-	0	0	-	0	0	-	0	0	-	28	4.2	5		V _{O-P}
V _{18L}	Vertical output minimum voltage	18	D SG17	9.0V	9.0V	0V	0V	-	3.7V	9.0V	4.5V	0	-	0	0	0	-	0	0	-	0	0	-	0	0	-	29		0	0.3	V _{O-P}
G _{VV}	Vertical open loop gain	17 18	E SG19	-	-	-	-	-	14.5V	3.7V	9.0V	0	-	-	-	-	-	-	-	-	-	-	-	-	-	-	16	22	28	dB	
V _{19 min}	Vertical oscillator starting voltage	16 19	-	9.0V	9.0V	0V	0V	-	9.0V	4.5V	0	-	0	0	0	-	0	0	-	0	0	-	0	0	-	0	0		5	6.5	V
V _{RAMP}	Ramp peak voltage	16	D SG17	9.0V	9.0V	0V	0V	-	9.0V	4.5V	0	-	0	0	0	-	0	0	-	0	0	-	0	0	-	0	0	4.60	4.90	5.30	V _{O-P}
V _{RAMP}	Ramp peak amplitude	16	D SG17	9.0V	9.0V	0V	0V	-	9.0V	4.5V	0	-	0	0	0	-	0	0	-	0	0	-	0	0	-	0	0	1.20	1.45	1.85	V _{P-P}
f _{V60}	Vertical free run frequency 60Hz	16	D SG18	9.0V	9.0V	0V	0V	-	9.0V	4.5V	0	-	0	0	0	-	0	0	-	0	0	-	0	0	-	0	0	51.8	52.8	53.8	Hz
f _{VP60}	Vertical pull-in frequency 60Hz	16	D SG20 variable	9.0V	9.0V	0V	0V	-	9.0V	4.5V	0	-	0	0	0	-	0	0	-	0	0	-	0	0	-	0	0	65.7	66.7	67.7	Hz
T _{V60}	Vertical output pulse width 60Hz	16	D SG17	9.0V	9.0V	0V	0V	-	9.0V	4.5V	0	-	0	0	0	-	0	0	-	0	0	-	0	0	-	0	0	494	544	594	μs
V _{th50/60}	50Hz, 60Hz SW threshold voltage	16 26	D SG18	9.0V	9.0V	0V	0V	-	9.0V	4.5V	0	-	0	0	0	-	0	0	-	0	0	-	0	0	-	0	0	2.05	2.25	2.45	V

* : - Indicates open.

M51408SP

PAL/NTSC SYSTEM SINGLE-CHIP COLOR TV SIGNAL PROCESSOR

VIDEO SECTION

Symbol	Parameter	Point	Input ()	Test conditions *																			Limits			Unit										
				1A	16A	19A	21A	22A	29A	36A	38A	39A	40A	S19A	S19A	S22A	S24A	S27A	S28A	S28A	S35A	S36A	S39A	S42A	S44A		Note	Min.	Typ.	Max.						
I _{CC19}	Circuit current	A19	—	—	9.0 V	—	—	—	—	4.5 V	2.7 V	—	—	—	—	—	—	—	—	—	—	—	—	—	—	—	—	30	40	50	mA					
Y _{max}	Maximum output	22	F SG21	—	9.0 V	—	—	—	—	9.0 V	Variable	—	—	—	—	—	—	—	—	—	—	—	—	—	—	—	35	5.0	6.2	—	V _{P-P}					
G _V	Standard gain	22	F SG22	—	9.0 V	—	—	—	—	4.5 V	Variable	—	—	—	—	—	—	—	—	—	—	—	—	—	—	—	36	11	15	19	dB					
G _{V min}	Contrast control characteristics	22	F SG22	—	9.0 V	—	—	—	—	2.5 V	Variable	—	—	—	—	—	—	—	—	—	—	—	—	—	—	—	37	—	-45	30	dB					
G _{V max}																																+2	+6	+8.5		
V _{BRT-I-norm}	Brightness control characteristics I	22	D SG18	12 V	9.0 V	—	—	—	—	4.5 V	Variable	—	—	—	—	—	—	—	—	—	—	—	—	—	—	—	—	—	—	—	—	—				
V _{BRT-I-L}																																	2.75	3.1	3.45	V _{O-P}
V _{BRT-I-H}																																	2.25	2.6	2.95	V _{O-P}
V _{BRT-II-norm}	Brightness control characteristics II	22	D SG18	12 V	9.0 V	—	—	—	—	4.5 V	Variable	—	—	—	—	—	—	—	—	—	—	—	—	—	—	—	—	—	—	—	—	—				
V _{BRT-II-L}																																	2.75	3.1	3.45	V _{O-P}
V _{BRT-II-H}																																	1.85	2.0	2.35	V _{O-P}
G _P	Peaking value	22	F SG23 SG24	—	9.0 V	—	—	—	—	4.5 V	Variable	—	—	—	—	—	—	—	—	—	—	—	—	—	—	—	38	7.5	11	14.5	dB					
G _{T norm}	Video tone control characteristics	22	F SG24	—	9.0 V	—	—	—	—	4.5 V	Variable	—	—	—	—	—	—	—	—	—	—	—	—	—	—	—	—	—	—	—	—	—				
G _{T min}																																	4.5 V	6.5 V	—	dB
G _{T max}																																	21	15	-11	dB
f _{b (γ)}	Frequency characteristics	22	F SG25	—	9.0 V	—	—	—	—	4.5 V	Variable	—	—	—	—	—	—	—	—	—	—	—	—	—	—	—	40	7	8	—	MHz					
DG _V	Differential gain	22	F SG22	—	9.0 V	—	—	—	—	4.5 V	Variable	—	—	—	—	—	—	—	—	—	—	—	—	—	—	—	—	41	—	1	6	%				
V ₄₀	Pin ④ voltage	40	—	—	9.0 V	—	—	—	—	4.5 V	M	—	—	—	—	—	—	—	—	—	—	—	—	—	—	—	—	4.15	4.45	4.75	V					
V _{BLK V}	Vertical blanking voltage	22	—	12 V	9.0 V	—	—	—	—	2.5 V	Variable	—	—	—	—	—	—	—	—	—	—	—	—	—	—	—	42	7.3	7.7	—	V _{O-P}					
V _{BLK TV50}	Vertical blanking width	22	—	12 V	9.0 V	—	—	—	—	2.5 V	Variable	—	—	—	—	—	—	—	—	—	—	—	—	—	—	—	43	1.31	1.38	1.44	ms					
V _{BLK H}	Horizontal blanking threshold voltage	22 25A	H SG28 0.5 V _{P-P}	—	9.0 V	—	—	—	—	2.5 V	Variable	—	—	—	—	—	—	—	—	—	—	—	—	—	—	—	44	6.35	6.8	—	V _{O-P}					
V _{DC REG}	DC regeneration variable characteristics	22	F SG17	—	9.0 V	—	—	—	—	4.5 V	—	—	—	—	—	—	—	—	—	—	—	—	—	—	—	—	45	-1.2	-0.2	1.0	V					

* : Indicates open.

M51408SP

PAL/NTSC SYSTEM SINGLE-CHIP COLOR TV SIGNAL PROCESSOR

CHROMA SECTION 1

Symbol	Parameter	Test point	Input ()	Test conditions *																			Limits			Unit																			
				11 A	16 A	19 V	21 V	22 A	29 V	36 V	38 V	39 V	40 V	42 V	S19 A	S19 V	S22 A	S22 V	S24 A	S24 V	S27 A	S27 V	S28 A	S28 V	S29 A		S29 V	S35 A	S35 V	S36 A	S36 V	S39 A	S39 V	S42 A	S42 V	Note	Min.	Typ.	Max.						
C _{max}	Chroma maximum output	34	G SG26 0dB	12 V	9.0 V	6.5 V	6.5 V	9.0 V																												0.6	1.0	1.5	V _{P-P}						
G _c	Chroma maximum gain	34	G SG26 -26dB	12 V	9.0 V	6.5 V	6.5 V	9.0 V																												36	40	46	dB						
Acc - I	ACC Characteristics	34	G SG26 -20dB	12 V	9.0 V		4.5 V	9.0 V																																					
Acc - II																																								G SG26 +6dB	47	-4	+0.6	+3.5	dB
V _{ik}	Killer operation input level	G 21	G SG26 Variable	12 V	9.0 V		4.5 V	9.0 V																													-42	-35	-30	dB					
V _{ok}	Killer color residual	34	G SG26 0dB	12 V	9.0 V		9.0 V	9.0 V																															-	15	35	mV _{P-P}			
C _{norm}	Chroma normal output	34	G SG26 0dB	12 V	9.0 V		4.5 V	9.0 V																															0.11	0.16	0.27	V _{P-P}			
C _{S min}	Color control characteristics I	34	G SG26 0dB	12 V	9.0 V	2.5 V	4.5 V	9.0 V																																					
C _{S max}																																												5	8
C _{u min}	Color control characteristics II	34	G SG26 0dB	12 V	9.0 V	2.5 V	6.5 V	9.0 V																																					
C _{u max}																																													
f _{PC L}	APC Pull - in	21 G	G SG27 0dB	12 V	9.0 V	4.5 V	9.0 V																																						
f _{PC H}																																													-0.3
f _{PC}	Total APC range	G 21	G SG27 0dB	12 V	9.0 V	4.5 V	9.0 V																																		0.6	1.2	-	kHz	
V ₂₃	Demodulated output DC voltage	23A	-	12 V	9.0 V		4.5 V	9.0 V																																					
V ₂₄		24A	-	12 V	9.0 V		4.5 V	9.0 V																																					
V ₂₅		25A	-	12 V	9.0 V		4.5 V	9.0 V																																					

* : - Indicates open.

CHROMA SECTION 2

Symbol	Parameter	Test point	Input ()	Test conditions *																			Limits			Unit																								
				11 A	16 A	19 V	21 V	22 A	25 V	36 V	38 V	39 V	40 V	42 V	S19 A	S19 V	S22 A	S22 V	S24 A	S24 V	S27 A	S27 V	S28 A	S28 V	S35 A		S35 V	S36 A	S36 V	S39 A	S39 V	S42 A	S42 V	Note	Min.	Typ.	Max.													
V ₂₃₋₂₄	Demodulated output DC offset voltage	-	-																																															
V ₂₄₋₂₅		-	-																																															
V ₂₅₋₂₃		-	-																																															
D _{max-P}	Demodulated output maximum amplitude	25A	G SG26 0dB	12 V	9.0 V	6.5 V	6.5 V	9.0 V																																										
D _{B-Y}	B-Y Demodulation sensitivity	25A	H SG28 0.2 V _{P-P}	12 V	9.0 V		4.5 V	9.0 V																																							2.1	3.4	4.3	V _{P-P}
$(\frac{R-Y}{B-Y})_P$	Demodulation ratio	23A	H SG28 0.2 V _{P-P}	12 V	9.0 V		4.5 V	9.0 V																																										
$(\frac{G-Y}{B-Y})_P$		24A	H SG28 0.2 V _{P-P}	12 V	9.0 V		4.5 V	9.0 V																																										
$(\frac{R-Y}{B-Y})_P$		25A	H SG28 0.2 V _{P-P}	12 V	9.0 V		4.5 V	9.0 V																																										

* : - Indicates open.

M51408SP

PAL/NTSC SYSTEM SINGLE-CHIP COLOR TV SIGNAL PROCESSOR

CHROMA SECTION 2 (cont.)

Symbol	Parameter	Test point	Input ()	Test conditions *																				Limits			Unit				
				11A	16A	19	21	22A	29	36	38	39	40	42	S19	S19A	S22	S24	S27	S27A	S28	S28A	S35	S36	S39	S42		No. of tests	Min.	Typ.	Max.
Δ DHR-Y	Demodulated output 1H level	23A	H SG28 0.2 VP-P	12V	9.0V	2.5V	2.5V	9.0V	-	-	-	-	-	-	-	-	-	-	-	-	-	-	-	-	-	57	-	-	35	mVP-P	
Δ DHG-Y		24A	-	12V	9.0V	2.5V	2.5V	9.0V	-	-	-	-	-	-	-	-	-	-	-	-	-	-	-	-	-	-	-	-	-	-	-
CLB-Y	Demodulated output carrier leak	25A	-	12V	9.0V	2.5V	2.5V	9.0V	-	-	-	-	-	-	-	-	-	-	-	-	-	-	-	-	-	-	-	-	-	0.2	VP-P
CLR-Y		23A	-	12V	9.0V	2.5V	2.5V	9.0V	-	-	-	-	-	-	-	-	-	-	-	-	-	-	-	-	-	-	-	-	-	-	-
CLG-Y		24A	-	12V	9.0V	2.5V	2.5V	9.0V	-	-	-	-	-	-	-	-	-	-	-	-	-	-	-	-	-	-	-	-	-	-	-
V21	Pin ② voltage	21	G SG26 0dB	12V	9.0V	M	4.5V	9.0V	-	-	-	-	-	-	-	-	-	-	-	-	-	-	-	-	-	-	-	4.2	4.5	4.8	V
V21K		21	-	-	-	-	-	-	-	-	-	-	-	-	-	-	-	-	-	-	-	-	-	-	-	-	-	-	0.1	0.35	V
D _{BWR} -Y	Demodulated output bandwidth	23	H SG30	12V	9.0V	-	4.5V	9.0V	-	-	-	-	-	-	-	-	-	-	-	-	-	-	-	-	-	-	-	0.8	1	-	MHz
D _{BWG} -Y		24	-	12V	9.0V	-	4.5V	9.0V	-	-	-	-	-	-	-	-	-	-	-	-	-	-	-	-	-	-	-	-	-	-	-
D _{BWU} -Y		25	-	12V	9.0V	-	4.5V	9.0V	-	-	-	-	-	-	-	-	-	-	-	-	-	-	-	-	-	-	-	-	-	-	-
C _{in max}	Chroma input dynamic range	G 34	G SG25 Variable	12V	9.0V	-	4.5V	9.0V	-	-	-	-	-	-	-	-	-	-	-	-	-	-	-	-	-	-	-	1.0	1.4	-	VP-P
\angle R-Y-P	Demodulated phase angle	23A	H SG28 0.2 VP-P	12V	9.0V	-	4.5V	9.0V	-	-	-	-	-	-	-	-	-	-	-	-	-	-	-	-	-	-	-	-	90	-	deg.
\angle G-Y-P		25A	-	12V	9.0V	-	4.5V	9.0V	-	-	-	-	-	-	-	-	-	-	-	-	-	-	-	-	-	-	-	-	240	-	deg.
		24A	-	12V	9.0V	-	4.5V	9.0V	-	-	-	-	-	-	-	-	-	-	-	-	-	-	-	-	-	-	-	-	-	-	-

* : - Indicates open.

CHROMA SECTION 3

Symbol	Parameter	Test point	Input ()	Test conditions *																				Limits			Unit				
				11A	16A	19	21	22A	29	36	38	39	40	42	S19	S19A	S22	S24	S27	S27A	S28	S28A	S35	S36	S39	S42		No. of tests	Min.	Typ.	Max.
Δ V _{p-c}	Color tracking characteristics	22	F SG22	12V	9.0V	-	4.0V 4.5V	9.0V 9.0V	-	-	-	-	-	-	-	-	-	-	-	-	-	-	-	-	-	-	-	-	-	-	-
		25A	G SG26 0dB	12V	9.0V	-	4.0V 4.5V	9.0V	-	-	-	-	-	-	-	-	-	-	-	-	-	-	-	-	-	-	-	-	6	2	2
SS _v	Service switch operation	22	F SG22	12V	9.0V	-	4.5V	9.0V	-	-	-	-	-	-	-	-	-	-	-	-	-	-	-	-	-	-	-	-	-	100	mVP-P
SS _c		34	G SG26 0dB	12V	9.0V	-	4.5V	9.0V	-	-	-	-	-	-	-	-	-	-	-	-	-	-	-	-	-	-	-	-	-	100	mVP-P
SS _v		16	-	-	-	-	-	-	-	-	-	-	-	-	-	-	-	-	-	-	-	-	-	-	-	-	-	-	-	0.3	V _G -P
CTS	Color tracking switch operation	G 34	G SG26 0dB	12V	9.0V	-	4.5V	9.0V	-	-	-	-	-	-	-	-	-	-	-	-	-	-	-	-	-	-	-	3	6	9	dB
VMS	Video, chroma, muting switch operation	22	F SG17	12V	9.0V	-	4.5V	9.0V	-	-	-	-	-	-	-	-	-	-	-	-	-	-	-	-	-	-	-	5.6	6.2	6.8	V _G -P
CMS _H -Y		23A	G SG26 CdB	12V	9.0V	-	4.5V	9.0V	-	-	-	-	-	-	-	-	-	-	-	-	-	-	-	-	-	-	-	-	-	100	mVP-P
CMS _G -Y		24A	-	12V	9.0V	-	4.5V	9.0V	-	-	-	-	-	-	-	-	-	-	-	-	-	-	-	-	-	-	-	-	-	-	-
CMS _B -Y		23A	-	12V	9.0V	-	4.5V	9.0V	-	-	-	-	-	-	-	-	-	-	-	-	-	-	-	-	-	-	-	-	-	-	-
B _{max-N}	Demodulated output maximum amplitude NTSC	C 25A	G SG31 0dB	12V	9.0V	6.5V	2.6V	6.5V	-	-	-	-	-	-	-	-	-	-	-	-	-	-	-	-	-	-	-	4.0	5	-	VP-P
(R-Y) _N	Derodulation ratio	23A	G SG31 0dB	12V	9.0V	-	2V	4.5V	-	-	-	-	-	-	-	-	-	-	-	-	-	-	-	-	-	-	-	0.88	1.0	1.08	-
(B-Y) _N		25A	-	12V	9.0V	-	2V	4.5V	-	-	-	-	-	-	-	-	-	-	-	-	-	-	-	-	-	-	-	-	-	-	-
(G-Y) _N		24A	-	12V	9.0V	-	2V	4.5V	-	-	-	-	-	-	-	-	-	-	-	-	-	-	-	-	-	-	-	0.20	0.28	0.36	-
(B-Y) _N		25A	-	12V	9.0V	-	2V	4.5V	-	-	-	-	-	-	-	-	-	-	-	-	-	-	-	-	-	-	-	-	-	-	-

* : - Indicates open.

PAL/NTSC SYSTEM SINGLE-CHIP COLOR TV SIGNAL PROCESSOR

Note11. Limiting Sensitivity "LIM"

- a. Decreasing the level of SG19, test the input level at test point 3 when the 400 Hz element is 3dB down from "AF direct output signal voltage" V_{CAF} .

Note12. AMR "AMR"

- a. Test the 400 Hz element at test point 3 and make it "Vam."

$$AMR = 20 \log \frac{V_{OA}(mV_{rms})}{V_{am}(mV_{rms})} \text{ (dB)}$$

Note13. Maximum Attenuation "ATT"

- a. Test 400Hz element at pin ④ output.

$$ATT = 20 \log \frac{V_{O4 \text{ max}}}{\text{Test Value}} \text{ (dB)}$$

Note14. AF Driver Gain "GAF"

$$GAF = 20 \log \frac{V_{O4 \text{ max}}}{V_{OA}} \text{ (dB)}$$

Note15. Sound S/N "S/N AF"

- a. Test 20Hz~100kHz noise at pin ④ output.

$$S/N \text{ AF} = 20 \log \frac{V_{O4 \text{ max}}}{\text{Test Value}} \text{ (dB)}$$

Note16. Sync Separation Input Sensitivity Current "Iss"

- a. The current value is expressed as the value of constant current source I_{SS} where low voltage (approx. 3V) can be obtained for pin ④ output as current of constant current source I_{SS} is gradually increased.

Note17. Sync Separation Output Maximum Voltage "V43H"

Note18. Sync Separation Output Minimum Voltage "V43L"

- a. V_{43H} , V_{43L} are shown in the figure below.

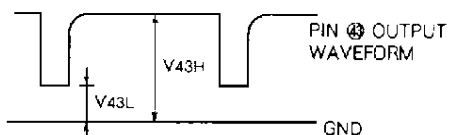

Note19. BGP Timing "TBGP-I, TBGP-II"

Note20. BGP Amplitude "VBGP-H, VBGP-L"

- a. T_{BGP-I} , T_{BGP-II} , V_{BGP-H} , V_{BGP-L} are shown in the figure below.

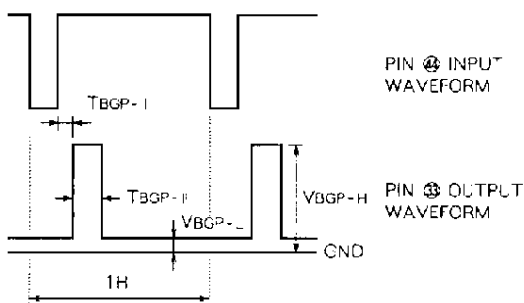

Note21. Horizontal Oscillator Starting Voltage "V11 min"

- a. Expressed as applied voltage of pin ⑪ where pin output waveform can be generated as the applied voltage of pin ⑪ is gradually increased from low voltage (approx. 3V).

Note22. Horizontal Pull-In Range "fPHL, fPHH"

- a. Decrease the frequency of input signal SG, B the proper amount and set while the input signal and output waveform of pin ⑫ are not in sync.
- b. Next, gradually increase the input frequency and test the input signal frequency exactly when the input signal and output waveform of pin ⑫ become synchronized.
- c. Perform in the same manner for pull-in range for upper side
- d. Expressed as difference from reference value of 15625 Hz.

Note23. Horizontal Output Maximum Voltage "V20H"

Note24. Horizontal Output Minimum Voltage "V20L"

Note25. Horizontal Output Pulse Width "TH"

- a. V_{20H} , V_{20L} , and T_H are shown in the figure below

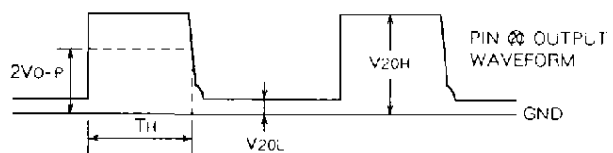

Note26. Overvoltage Detection Operation Voltage "VPRO"

- a. Expressed as applied voltage of pin ⑮ where output waveform of pin ⑮ such as shown in the figure below can be obtained as the applied voltage of pin ⑮ is gradually increased.

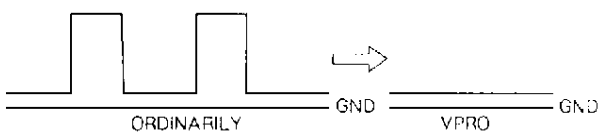

- b. Then release pin ⑮ applied voltage and make sure it is maintained.

Note27. Vertical Pull-In Frequency 50 (Hz) "fpv50"

- a. Increase the frequency of input signal SG20 the proper amount and set while the input signal and output waveform of pin ⑯ are not in sync.
- b. Next, gradually decrease the input frequency and test the input signal frequency exactly when the input signal and output waveform of pin ⑯ become synchronized.

Note28. Vertical Output Maximum Voltage "V18H"

PAL/NTSC SYSTEM SINGLE-CHIP COLOR TV SIGNAL PROCESSOR

Note29. Vertical Output Minimum Voltage "V18L"

- a. V18H and V18L are shown in the figure below.

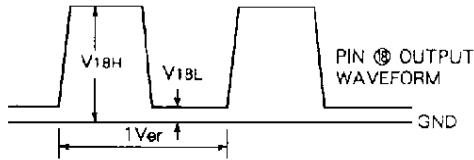

Note30. Vertical Open Loop Gain "Gv"

- a. Input SG19 (2 kHz, 100mVp-p, CW) into pin 17 and test the output amplitude of pin 18.

b. $G_{v} = 20 \log \frac{\text{Pin 18 Output Amplitude (mVp-p)}}{100\text{mVp-p}}$ (dB)

Note31. Vertical Oscillator Starting Voltage "V19 min"

- a. Expressed as applied voltage of pin 19 where pin output waveform of pin 16 can be generated as the applied voltage of pin 19 is gradually increased from low voltage (approx. 3V).

Note32. Ramp Peak Voltage "VRAMP"

Note33. Ramp Amplitude "VRAMP"

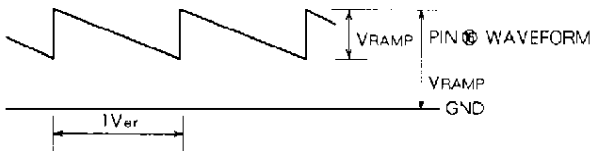

Note34. 50/60 Threshold Voltage "VTH50/60"

- a. Lower 2 voltage past 4V area.
b. Test 2 voltage when 16 output pulse frequency is switched from approx. 44Hz to approx. 53Hz.

Note35. Maximum Output "Ymax"

- a. Adjust applied voltage of pin 39 so that the DC potential of pin 22 is 4.5V.

Note36. Standard Gain "GY"

- a. Adjust applied voltage of pin 39 so that the DC potential of pin 22 is 3.0V.

b. $G_{Y} = 20 \log \frac{\text{Test Value mVp-p}}{200\text{mVp-p}}$ (dB)

Note37. Contrast Control Characteristics "GY min, GY max"

- a. Adjust applied voltage of pin 39 so that the DC potential of pin 22 is 3.0V.

(Apply voltage of pin 39 described in Note36.)

- b. Change 39 applied voltage to 2.5V / 6.5V and make VA and VB the test values of pin 22 output signal.

c. $G_{Y \text{ min}} = 20 \log \frac{V_{A} \text{ (mVp-p)}}{G_{Y \text{ Test Value (mVp-p)}}$ (dB)

$G_{Y \text{ max}} = 20 \log \frac{V_{B} \text{ (mVp-p)}}{G_{Y \text{ Test Value (mVp-p)}}$ (dB)

Note38. Peaking Value "GP"

- a. Adjust applied voltage of pin 39 so that the DC potential of pin 22 is 3.0V.

(Apply voltage of pin 39 described in Note36.)

- b. Make VA the output signal voltage of pin 22 at time of SG23 input, and make VB the output signal voltage of pin 22 at time of SG24 input.

c. $G_{P} = 20 \log \frac{V_{B}}{V_{A}}$ (dB)

Note39. Video Tone Control Characteristics "Gr norm, Gr min, Gr max"

- a. Adjust applied voltage of pin 39 so that the DC potential of pin 22 is 3.0V.

(Apply voltage of pin 39 described in Note36.)

- b. Change 40 applied voltage to 4.5V / 6.5V / 2.5V and make VA, VB, and VC the output signal voltages of pin 22.

c. $G_{T \text{ min}} = 20 \log \frac{V_{B}}{V_{A}}$ (dB), $G_{T \text{ max}} = 20 \log \frac{V_{C}}{V_{A}}$ (dB)

Gr norm (dB) is the amount of change with VB when GP was tested in Note38.

Note40. Frequency Characteristics "fa (v)"

- a. Adjust applied voltage of pin 39 so that the DC potential of pin 22 is 3.0V.

(Apply voltage of pin 39 described in Note36.)

- b. Test the frequency of SG.K 3 dB down from the VA value when GP was tested in Note38.

Note41. Differential Gain "DGY"

- a. Adjust applied voltage of pin 39, change DC potential of pin 22 to 4.0V and 2.0V, and make VA and VB the output signal voltages of pin 22.

b. $DGY = \frac{|V_{A} - V_{B}|}{V_{B}} \times 100\%$

Note42. Vertical Blanking Voltage "VBLK v"

Note43. Vertical Blanking Width (50) "VBLK TV50"

- a. In order to facilitate testing, apply 3.0V of applied voltage to pin 39 so that scanning period potential of pin 22 decreases.

- b. VBLK v and VBLK tv are shown in the figure below.

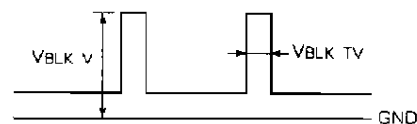

PAL/NTSC SYSTEM SINGLE-CHIP COLOR TV SIGNAL PROCESSOR

Note44. Horizontal Blanking Threshold Voltage "V_{BLK H}"

- In order to facilitate testing, apply 3.0V of applied voltage to pin ② so that scanning period potential of pin ③ decreases.
- Expressed as electric potential of pin ③ where no 25A output signal is obtained while gradually increasing the 22A applied voltage.

Note45. DC Playback Ratio Variable Characteristics "Y_{DCREG}"

- Make V_A the output pedestal potential of pin ③ when S42 is OFF, and make V_B the output pedestal potential of pin ③ when S42 is ON.
- $Y_{DCREG} = V_A - V_B$ (V)

Note46. Chroma Maximum Gain "G_c"

- Set SG26 to -26dB (Burst: 2.5mV_{PP}, Chroma: 5.0mV_{PP}) and test the output signal voltage of pin ④.
- $G_c = 20 \log \frac{\text{Test Value (mV}_{PP})}{5mV_{PP}}$ (dB)

Note47. ACC Characteristics "ACC-I, ACC-II"

- Change the SG26 input level to 0, -20, +6dB and make ④ output signal voltages V_A, V_B, and V_C respectively.
- $ACC-I = 20 \log \frac{V_B}{V_A}$ (dB), $ACC-II = 20 \log \frac{V_C}{V_A}$ (dB)

Note48. Killer Operation Input Level "V_{ik}"

- Expressed as the input level where direct current voltage of pin ① becomes low when SG26 input level is decreased.

Note49. Killer Color Residual "V_{ok}"

- Input SG29 and test output signal voltage of pin ④.

Note50. Chroma Normal Output "C_{norm}"

- Input SG26 and test the output signal voltage of pin ④ when ③ applied voltage is 4.5V.

Note51. Color Control Characteristics I "C_{s min}, C_{s max}"

- Change applied voltage of pin ② to 2.5V, 6.5V and make V_A and V_B the output signal voltages of pin ④.
- $C_{s \min} = 20 \log \frac{V_A}{C_{norm} \text{ Test Value}}$ (dB)
 $C_{s \max} = 20 \log \frac{V_B}{C_{norm} \text{ Test Value}}$ (dB)

Note52. Color Control Characteristics II "C_{u min}, C_{u max}"

- Change ③ applied voltage to 2.5V, 6.5V and make V_A and V_B the output signal voltages of pin ④.
- $C_{u \min} = 20 \log \frac{V_A}{C_{norm} \text{ Test Value}}$ (dB)
 $C_{u \max} = 20 \log \frac{V_B}{C_{norm} \text{ Test Value}}$ (dB)

Note53. APC Pull-In range "f_{pc L}, f_{pc H}"

- Input SG27, decrease burst and chroma frequency (f_{sb} = f_{sc}) the proper amount and set so that the DC voltage of pin ② is low.
- Test the input frequency where the DC voltage of pin ② changes from low to high (=4.5) while gradually increasing the frequency.
- Test upper side pull-in frequency in the same manner.
- Limit value is expressed as difference from reference value 4433619Hz.

Note54. Total APC Range "f_{pc}"

Note55. B-Y Demodulation Sensitivity "D_{B-Y}"

Note 56. PAL Demodulation Ratio $\left(\frac{R-Y}{B-Y}\right)_P, \left(\frac{G-Y}{B-Y}\right)_P$

- Input SG28 0.2V_{PP} and test output signal voltages of 23A, 24A, and 25A.
- $\left(\frac{R-Y}{B-Y}\right)_P = \frac{23A \text{ Output Signal Voltage}}{25A \text{ Output Signal Voltage}}$
 $\left(\frac{G-Y}{B-Y}\right)_P = \frac{24A \text{ Output Signal Voltage}}{25A \text{ Output Signal Voltage}}$

Note57. Demodulated Output 1H Level Difference

"ΔDHR-Y, ΔDHG-Y"

- ΔDHR-Y and ΔDHG-Y are shown in the figure below.

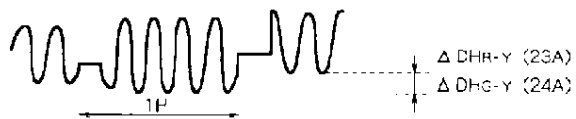

Note58. Demodulated Output Bandwidth

"D_{BW R-Y}, D_{BW G-Y}, D_{BW B-Y}"

- Input SG30 and test while changing the input frequency.
Test the input frequency when output is 3dB down at time of 4.443MHz (approx. +10kHz) input.
- Make the limit value the input frequency test value -4.433 (MHz).

Note59. Chroma Input Dynamic Range "C_{in max}"

- Expressed as the input level where the output waveform of pin ④ begins to distort as the SG26 level is increased.

Note60. Demodulated Phase Angle "∠R-Y-P, ∠G-Y-P"

- Test the phase difference of R-Y output (23A) and G-Y output (24A) relative to the phase difference of B-Y output (25A).

PAL/NTSC SYSTEM SINGLE-CHIP COLOR TV SIGNAL PROCESSOR

Note61. Color Tracking Characteristics "ΔV_{P-C}"

- a. Adjust applied voltage of pin ⑨ so that the DC potential of pin ⑫ is 3.0V. (Apply voltage of pin ⑨ described in Note36.)
- b. Input SG22 into input F, change ⑩ applied voltage to 4.0V, 4.5V and make V_A and V_B the test values of the output signal of pin ⑫.
- c. Next add SG17 to input D.
- d. Add SG26 to input G, change ⑩ applied voltage to 4.0V, 4.5V and make V_C and V_D the test values of B-Y output (25A).
- e. $\Delta V_{P-C} = 20 \log \frac{V_B}{V_A} - 20 \log \frac{V_D}{V_C}$ (dB)

Note62. Service Switch Operation "SS_V, SS_C, SS_V"

- a. Adjust applied voltage of pin ⑨ so that the DC potential of pin ⑫ is 3.0V. (Apply voltage of pin ⑨ described in Note36.)
- b. Input SG22 into input F, turn S36 on, and test scanning period amplitude of the output signal of pin ⑫. (SS_V test of above.)
- c. Add SG17 to input D.
- d. Add SG26 to input G, turn S36 ON, and test pin ⑫ output signal amplitude. (SS_C test)

Note63. Color Tracking Switch Operation "CTS"

- a. Test output signal amplitude of pin ⑫ when S24 is OFF, and make V_A the test value.
- b. Make V_B the test value of "Chroma Normal Output" of Note50.
- c. $CTS = 20 \log \frac{V_B}{V_A}$ (dB)

Note64. Video Chroma Muting Switch Operation "VMS, CMS_{R-Y}, CMS_{G-Y}, CMS_{B-Y}"

- a. Input SG17 into input F, turn S39 ON, and test scanning period potential of the output signal of pin ⑫. (VMS Test)
- b. Input SG17 into input D, input SG26 into input G, turn S39 on, and test scanning period amplitude for R-Y output (23A), G-Y output (24A), B-Y output (25A). (CMS_{R-Y}, CMS_{G-Y}, CMS_{B-Y} Test)

Note65. NTSC Demodulation Ratio $\left(\frac{R-Y}{B-Y}\right)_N, \left(\frac{G-Y}{B-Y}\right)_N$

- a. Test output signal voltage at 23A, 24A, and 25A.
- b. $\left(\frac{R-Y}{B-Y}\right)_N = \frac{23A \text{ Output Signal Voltage}}{25A \text{ Output Signal Voltage}}$
 $\left(\frac{G-Y}{B-Y}\right)_N = \frac{23A \text{ Output Signal Voltage}}{25A \text{ Output Signal Voltage}}$

Note66. NTSC Demodulated Phase Angle "∠R-Y-N, ∠G-Y-N"

- a. Test the phase difference of R-Y output (23A) and G-Y output (24A) relative to the phase difference of B-Y output (25A).

Note67. Tint Control Characteristics "T_{min}, T_{max}"

- a. Set oscilloscope to X-Y, and connect 25A to X and 23A to Y.
- b. Open S29 and set frequency of SG27 to 4.433619MHz.
- c. When set, the oscilloscope waveform should be 180°.
- d. Short S29, and make T_{min} the remainder when 180° is subtracted from the angle when 29 is made 3 V.
- e. Make T_{max} the remainder when 180° is subtracted from the angle when ⑨ is made 1V.

Note68. NTSC Operation Voltage "V_{NTSC}"

- a. Decrease the voltage of ⑨ past the area of 5V.
- b. Test the voltage of ⑨ when signal ceases to be output by 25A.

M51408SP

PAL/NTSC SYSTEM SINGLE-CHIP COLOR TV SIGNAL PROCESSOR

Precautions When Testing Items Related to Chroma

The conditions listed below are usually set when testing items related to chroma (chroma maximum output, Notes 46–68).

- 1) Input: signal SG.A into D input.
- 2) Turn switches S5, S11A, S12, S12A, S13, S20, and S44 on.

Coil and Potentiometer Adjustment

VIF / SIF Type Coil Adjustment

1. Set V_{BRH} test conditions described in Note3.
2. Detune AFT coil.
3. Then adjust the applied voltage of pin ⑤ so that the tank response of pin ⑥ is 0.3V_{P-P}.
4. Adjust the DET coil so that the peak is 38.9MHz.

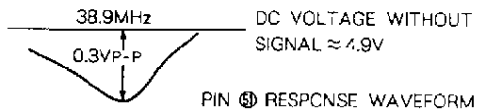

5. Set μ AFT test conditions of Note9 and adjust the AFT coil so that the electric potential is 4.5V at 38.9MHz as shown in the figure below.

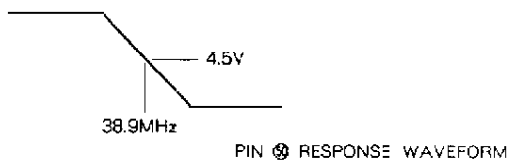

6. Set conditions for AF driver output V04 and adjust SIF coil so that distortion is minimized.

Horizontal Blanking Pulse Generation Potentiometer Adjustment

Adjust the one-shot multivibrator's potentiometer so that the timing of the horizontal blanking pulse and pulse width are as shown in the figure below.

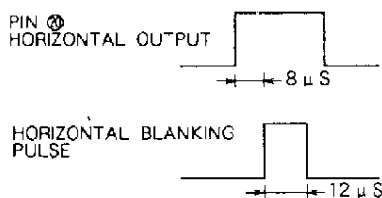

Set 8 μ s via the pin ⑤ potentiometer of TTLIC M74LS221P, and set 12 μ s via the pin ⑦ potentiometer.

Chroma Burst Coil and 1H D.L Section Adjustment

1. Set chroma normal output (C_{norm}) test conditions described in Note49 and adjust the pin ⑧ burst coil so that output amplitude of pin ④ is minimized.
2. Set conditions for demodulated output maximum amplitude D_{max} , open pin ⑨, and change applied voltage to 4.5V.
3. Monitoring test point 25A with an oscilloscope, re-adjust potentiometer and 1H D.L coil so that the amplitude difference for the entire 1H is minimized.
4. In order to confirm, monitor test point 23A (R-Yout) also.

M51408SP

PAL/NTSC SYSTEM SINGLE-CHIP COLOR TV SIGNAL PROCESSOR

INPUT SIGNAL

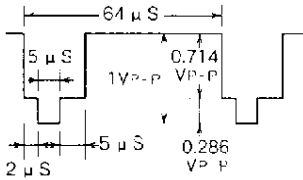
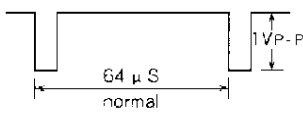
SG No.	Signals (50Ω termination)
SG1	$f_0 = 38.9\text{MHz}$, 90dB μ , $f_m = 16\text{kHz}$, AM77.8%
SG2	$f_0 = 38.9\text{MHz}$, 80dB μ , CW
SG3	$f_0 = 38.9\text{MHz}$, CW, variable level
SG4	$f_0 = 38.9\text{MHz}$, $f_m = 16\text{kHz}$, 16.0%, variable level
SG5	$f_0 = 38.9\text{MHz} \pm 5\text{MHz}$, 80dB μ , sweep signal
SG6	$f_0 = 37.9\text{MHz}$, 80dB μ , CW
SG7	$f_0 = 39.9\text{MHz}$, 80dB μ , CW
SG8	$f_1 = 38.9\text{MHz}$, 90dB μ , CW $f_2 = 33 \pm 5\text{MHz}$, 70dB μ , CW } Mixed Singnal
SG9	$f_1 = 38.9\text{MHz}$, 90dB μ , CW $f_2 = 34.47\text{MHz}$, 70dB μ , CW $f_3 = 33.4\text{MHz}$, 70dB μ , CW } Mixed Singnal
SG10	$f_0 = 38.9\text{MHz}$, 110dB, CW
SG11	$f_0 = 38.9\text{MHz}$, 60dB μ , CW
SG12	$f_0 = 5.5\text{MHz}$, 90dB μ , $f_m = 400\text{Hz}$, FM $\pm 25\text{kHz}$ dev.
SG13	$f_0 = 38.9\text{MHz}$, 90dB μ , 10-stage wave, 87.5% TV modulation ($f_{sc} = 4.43\text{MHz}$)
SG14	$f_0 = 5.5\text{MHz}$, $f_m = 400\text{Hz}$, FM $\pm 25\text{kHz}$ dev. variable level
SG15	$f_0 = 5.5\text{MHz}$, 90dB μ , $f_m = 400\text{Hz}$, AM30%
SG16	$f_0 = 5.5\text{MHz}$, 90dB μ , CW
SG17	Make input for sync separation PAL type APL 100% normal video signal shown in the figure on the right. Vertical must be interlaced at 50Hz. 
SG18	Horizontal sync signal duty 92% input level, and sync are variable. 
SG19	$f = 2\text{kHz}$, 100mVp-p, CW

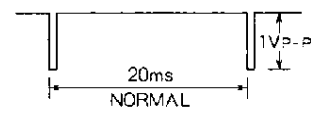
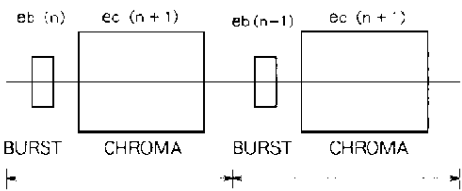
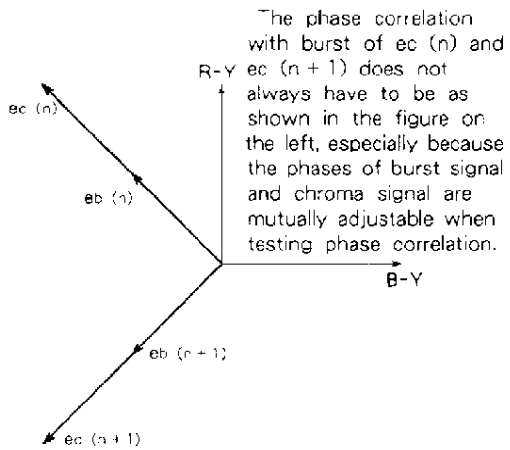
SG No.	Signals (50Ω termination)
SG20	 Vertical sync signal duty 92% input level and sync are variable.
SG21	$f = 200\text{kHz}$, 2Vp-p, CW
SG22	$f = 200\text{kHz}$, 200mVp-p, CW
SG23	$f = 200\text{kHz}$, 50mVp-p, CW
SG24	$f = 3\text{MHz}$, 50mVp-p, CW
SG25	$f = 3\text{MHz} \sim 10\text{MHz}$ (Variable), 50mVp-p, CW PAL Simple chroma signal  0dB is $eb = 50\text{mVp-p}$, $ec = 100\text{mVp-p}$. $f_{sb(n)} - f_{sc(n)} = 4.433619\text{MHz}$ (Same phase)
SG26	The correlation of phases for the signals given above is shown in the figure below.  The phase correlation with burst of $ec(n)$ and $ec(n+1)$ does not always have to be as shown in the figure on the left, especially because the phases of burst signal and chroma signal are mutually adjustable when testing phase correlation.

PAL/NTSC SYSTEM SINGLE-CHIP COLOR TV SIGNAL PROCESSOR

INPUT SIGNAL (cont.)

SG No.	Signals (50Ω termination)
SG27	With PAL simple chroma signals for SG26, the phase of burst and chroma signals should be the same and the frequency should be variable.
SG28	f = 4.53MHz, CW, Variable level
SG29	With PAL simple chroma signals for SG26, burst signal eb = 0mV _{P-P} , amplitude of chroma ec = 100mV _{P-P} .
SG30	f = 5.43MHz, CW, 0.2V _{P-P}
SG31	<p>SG26 PAL simple chroma signal (chroma signal fsc = 4.53MHz, burst signal fsb = 4.433619MHz) signal positioning is shown in the figure below.</p>
SG32	<p>The signal positioning for PAL simple chroma signal for SG26, signal positioning is shown in the figure below.</p>

M51408SP

PAL/NTSC SYSTEM SINGLE-CHIP COLOR TV SIGNAL PROCESSOR

TEST CIRCUIT

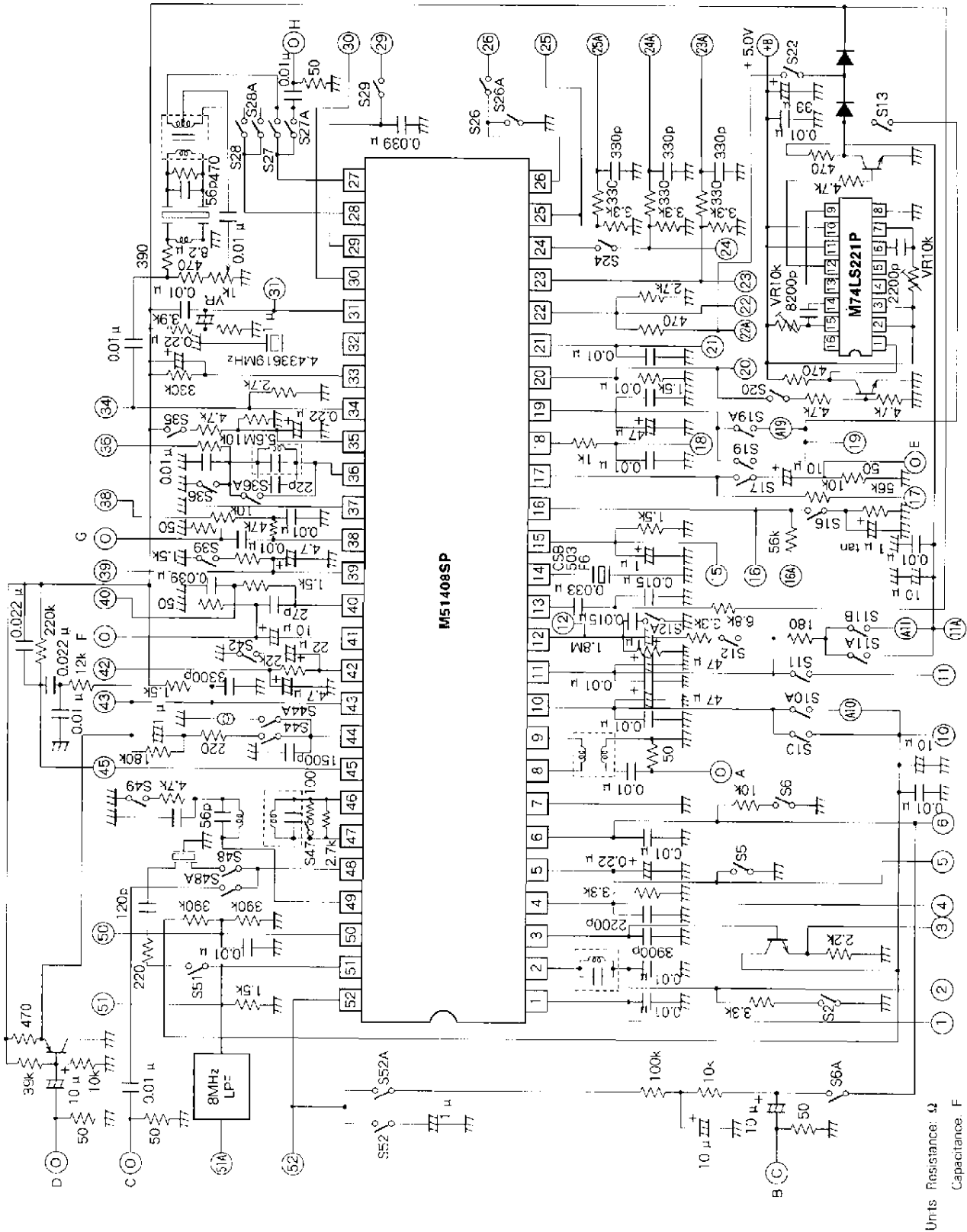

M51408SP

PAL/NTSC SYSTEM SINGLE-CHIP COLOR TV SIGNAL PROCESSOR

TYPICAL CHARACTERISTICS

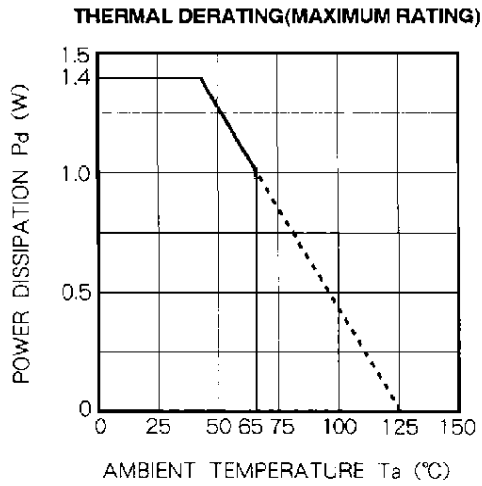

PAL/NTSC SYSTEM SINGLE-CHIP COLOR TV SIGNAL PROCESSOR

APPLICATION EXAMPLE

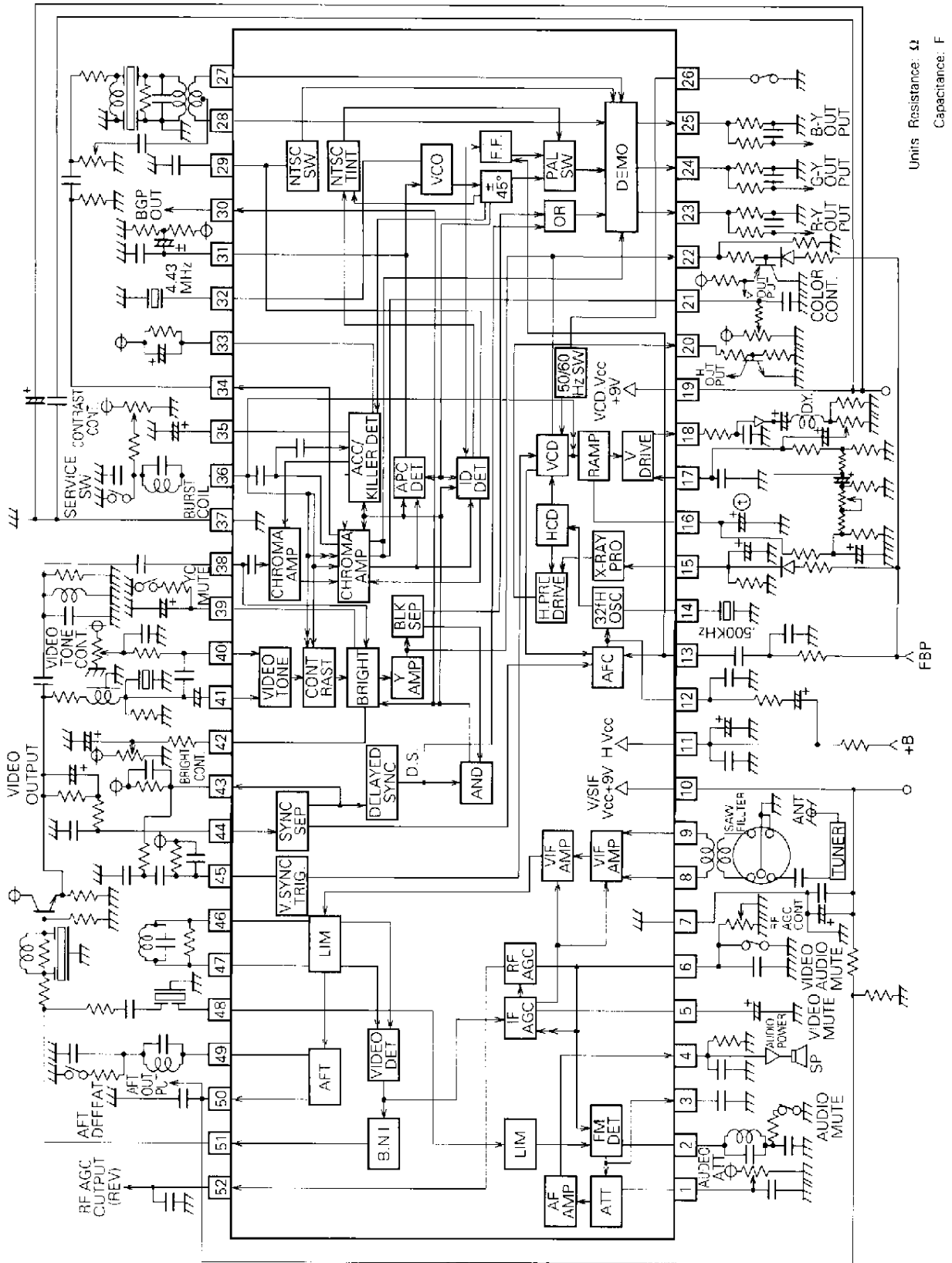

PAL/NTSC SYSTEM SINGLE-CHIP COLOR TV SIGNAL PROCESSOR

DESCRIPTION OF PIN

Pin No.	Name	Peripheral circuit: of pins	Pin No.	Name	Peripheral circuit: of pins
①	ATT		⑤	IF AGC FILTER	
②	SOUND DET COIL		⑥	RF AGC DELAY ADJ.	
③	SOUND DET OUT		⑦	GND 1 (VIF SIF)	—
④	AF OUT		⑧	VIF IN	
			⑨	VIF IN	
			⑩	Vcc 1 (VIF SIF)	—

PAL/NTSC SYSTEM SINGLE-CHIP COLOR TV SIGNAL PROCESSOR

DESCRIPTION OF PIN (cont.)

Pin No.	Name	Peripheral circuit of pins	Pin No.	Name	Peripheral circuit of pins
⑪	H.Vcc		⑮	X-RAY PROT	
⑫	AFC FILTER		⑯	RAMP	
⑬	AFC FBP IN		⑰	V.FB	
⑭	32fh OSC		⑱	V.OUT	
			⑲	Vcc-2 (VCC)	

M51408SP

PAL/NTSC SYSTEM SINGLE-CHIP COLOR TV SIGNAL PROCESSOR

DESCRIPTION OF PIN (cont.)

Pin No.	Name	Peripheral circuit of pins	Pin No.	Name	Peripheral circuit of pins
20	H.OUT		25	B-Y OUT	
21	COLOR CONT.		26	5C/60 Hz SW	
22	Y OUT		27	R-Y IN	
23	R-Y OUT		28	B-Y IN	
24	G-Y OUT/ COLOR TRACKING SW		29	IDENT FI. TFR/ NTSC SW/ NTSC TINT	

M51408SP

PAL/NTSC SYSTEM SINGLE-CHIP COLOR TV SIGNAL PROCESSOR

DESCRIPTION OF PIN (cont.)

Pin No.	Name	Peripheral circuit of pins	Pin No.	Name	Peripheral circuit of pins
30	BGP OUT		34	CHROMA OUT	
31	A ² C FILTER		35	KILLER FILTER	
32	CHROMA OSC		36	CONTRAST CONT. / BURST COIL	
33	ACC FILTER		37	GND-2 (VCD)	---
38	CHROMA IN	---	38	CHROMA IN	
39	PEDESTAL CLAMP	---	39	PEDESTAL CLAMP	

M51408SP

PAL/NTSC SYSTEM SINGLE-CHIP COLOR TV SIGNAL PROCESSOR

DESCRIPTION OF PIN (cont.)

Pin No.	Name	Peripheral circuit of pins	Pin No.	Name	Peripheral circuit of pins
40	VIDEO TONE CONT.		44	SYNC IN	
41	Y IN		45	V.SYNC IN	
42	BRIGHTNESS CONT.		46	VIDEO DET COIL	
43	SYNC OUT		47	VIDEO DET COIL	
			48	SIF IN	

M51408SP

PAL/NTSC SYSTEM SINGLE-CHIP COLOR TV SIGNAL PROCESSOR

DESCRIPTION OF PIN (cont.)

Pin No.	Name	Peripheral circuit of pins
49	AFT COIL	
50	AFT OUT	
51	VIDEO OUT	
52	RF AGC OUT	