

M54567P/FP

4-UNIT 1.5A DARLINGTON TRANSISTOR ARRAY WITH CLAMP DIODE

DESCRIPTION

M54567P and M54567FP are four-circuit Darlington transistor arrays with clamping diodes. The circuits are made of PNP and NPN transistors. Both the semiconductor integrated circuits perform high-current driving with extremely low input-current supply.

FEATURES

- High breakdown voltage ($BV_{CEO} \geq 50V$)
- High-current driving ($I_{c(max)} = 1.5A$)
- With clamping diodes
- Driving available with NMOS IC output
- Wide operating temperature range ($T_a = -20$ to $+75^\circ C$)

APPLICATION

Drives of relays and printers, digit drives of indication elements (LEDs and lamps), and power amplification

FUNCTION

The M54567P and M54567FP each have four circuits, which are made of PNP transistors and NPN Darlington transistors. The input has $8k\Omega$, and a spike-killer clamping diode is provided between the output pin (collector) and COM pin. All output transistor emitters are connected to the GND pin. Collector current is 1.5A maximum. The maximum collector-emitter voltage is 50V. The M54567FP is enclosed in a molded small flat package, enabling space-saving design.

PIN CONFIGURATION

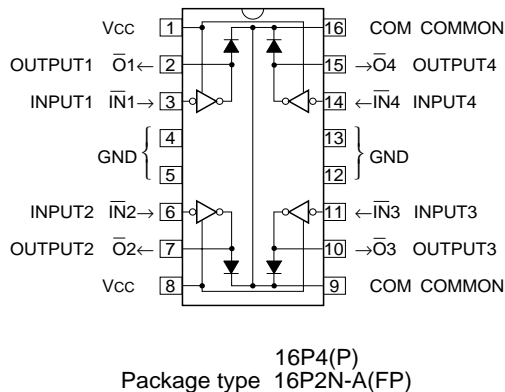

CIRCUIT DIAGRAM

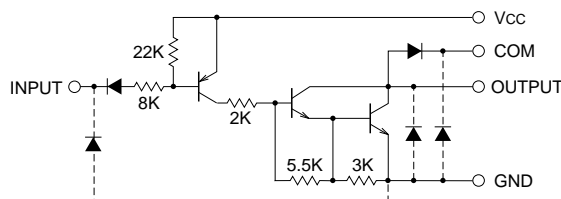

The four circuits share the COM and GND.
The diode, indicated with the dotted line, is parasitic, and cannot be used.

Unit : Ω

ABSOLUTE MAXIMUM RATINGS (Unless otherwise noted, $T_a = -20 \sim +75^\circ C$)

Symbol	Parameter	Conditions	Ratings	Unit
V _{CC}	Supply voltage		10	V
V _{CEO}	Collector-emitter voltage	Output, H	-0.5 ~ +50	V
I _C	Collector current	Current per circuit output, L	1.5	A
V _I	Input voltage		-0.5 ~ +30	V
V _R	Clamping diode reverse voltage		50	V
I _F	Clamping diode forward current	Pulse Width $\leq 10ms$, Duty Cycle $\leq 5\%$	1.5	A
		Pulse Width $\leq 100ms$, Duty Cycle $\leq 5\%$	1.0	
P _d	Power dissipation	$T_a = 25^\circ C$, when mounted on board	1.92(P)/1.00(FP)	W
T _{opr}	Operating temperature		-20 ~ +75	$^\circ C$
T _{stg}	Storage temperature		-55 ~ +125	$^\circ C$

M54567P/FP

4-UNIT 1.5A DARLINGTON TRANSISTOR ARRAY WITH CLAMP DIODE

RECOMMENDED OPERATING CONDITIONS (Unless otherwise noted, Ta = -20 ~ +75°C)

Symbol	Parameter	Limits			Unit	
		min	typ	max		
Vcc	Supply voltage	4	5	6	V	
Vo	Output voltage	0	—	50	V	
Ic	Collector current (Current per 1 circuit when 4 circuits are coming on simultaneously)	Vcc = 5V, Duty Cycle P : no more than 4% FP : no more than 2%	0	—	1.25	A
		Vcc = 5V, Duty Cycle P : no more than 18% FP : no more than 9%	0	—	0.7	
VIH	"H" input voltage	Vcc-0.5	—	Vcc	V	
VIL	"L" input voltage	0	—	Vcc-3.5	V	

ELECTRICAL CHARACTERISTICS (Unless otherwise noted, Ta = -20 ~ +75°C)

Symbol	Parameter	Test conditions	Limits			Unit
			min	typ*	max	
V (BR) CEO	Collector-emitter breakdown voltage	ICEO = 100μA	50	—	—	V
ICC	Supply current (One circuit coming on)	Vcc = 6V, VI = 0.5V	—	3.0	4.5	mA
VCE (sat)	Collector-emitter saturation voltage	Vcc = 4V, VI = 0.5V, Ic = 1.25A	—	1.6	2.2	V
		Vcc = 4V, VI = 0.5V, Ic = 0.7A	—	1.1	1.7	
II	Input current	VI = Vcc-3.5V	—	-0.3	-0.6	mA
		VI = Vcc-6V	—	-0.58	-0.95	
IR	Clamping diode reverse current	VR = 50V	—	—	100	μA
VF	Clamping diode forward voltage	IF = 1.25A, Vcc open	—	1.6	2.3	V
hFE	DC amplification factor	Vcc = 4V, VCE = 4V, Ic = 1A, Ta = 25°C	4000	30000	—	—

* : The typical values are those measured under ambient temperature (Ta) of 25°C. There is no guarantee that these values are obtained under any conditions.

SWITCHING CHARACTERISTICS (Unless otherwise noted, Ta = 25°C)

Symbol	Parameter	Test conditions	Limits			Unit
			min	typ	max	
ton	Turn-on time	CL = 15pF (note 1)	—	190	—	ns
toff	Turn-off time		—	5300	—	ns

NOTE 1 TEST CIRCUIT

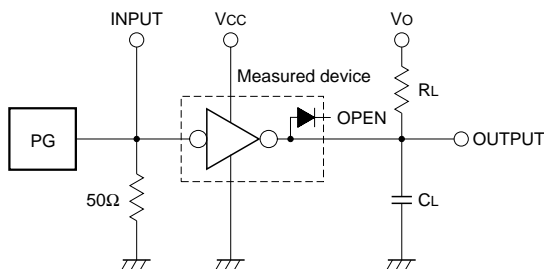

- (1) Pulse generator (PG) characteristics : PRR = 1kHz,
tw = 10μs, tr = 6ns, tf = 6ns, Zo = 50Ω
VI = 0.5 to 4V
- (2) Input-output conditions : RL = 8.3Ω, Vo = 10V, Vcc = 4V
- (3) Electrostatic capacity CL includes floating capacitance at connections and input capacitance at probes

TIMING DIAGRAM

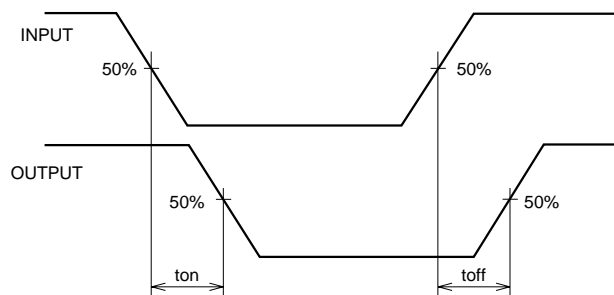

TYPICAL CHARACTERISTICS

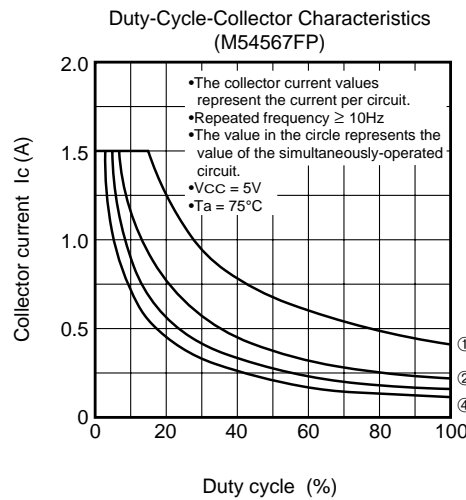
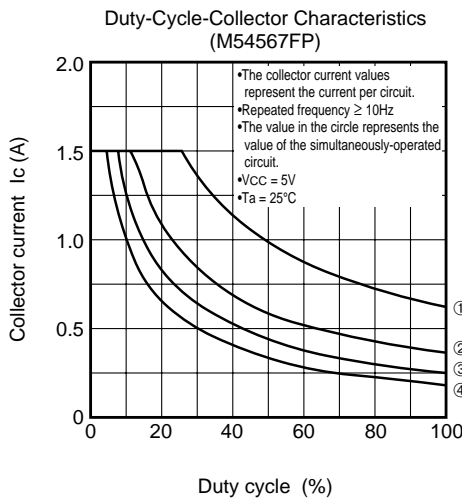
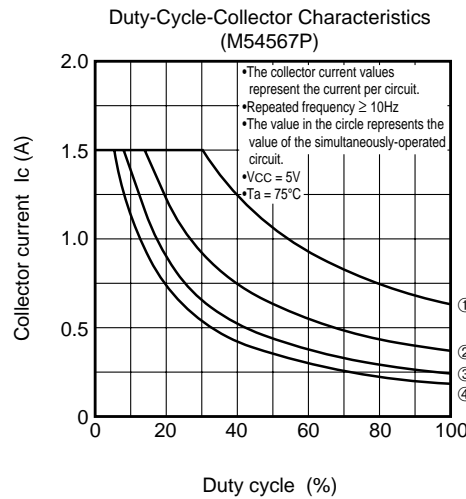
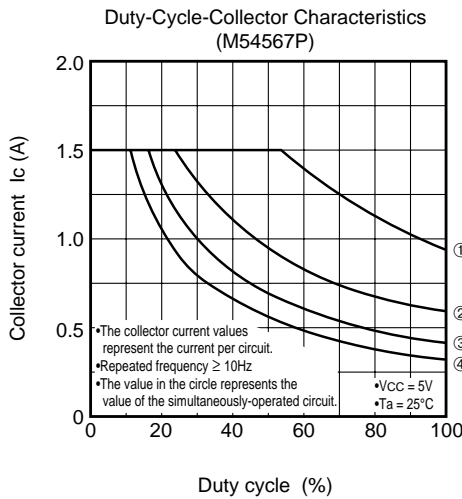
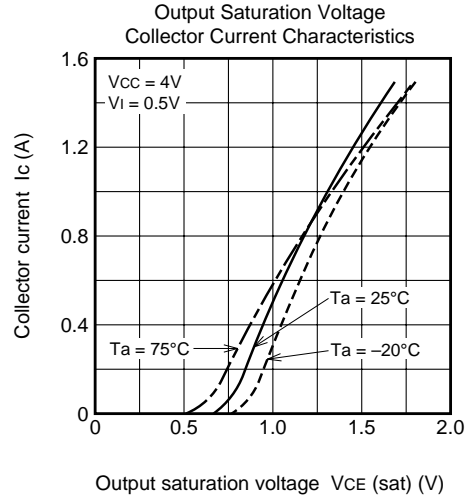
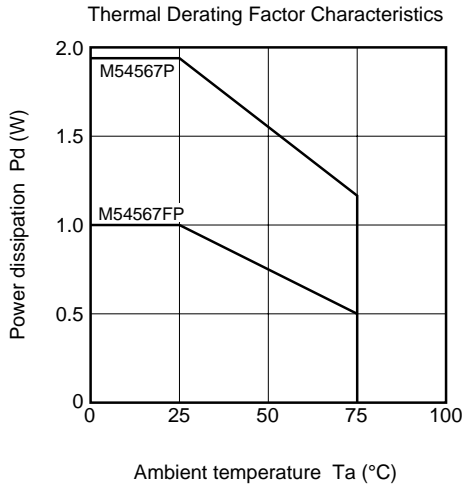

4-UNIT 1.5A DARLINGTON TRANSISTOR ARRAY WITH CLAMP DIODE

