

## *Current Mode Control PWM Regulator IC For Switching Power Supplies*

**Features and Benefits**

- TO-220F power package with 30 to 90 W power output
- Current Mode PWM control
- Built-in Random Switching function, reducing EMI noise, and simplifying EMI filters, and therefore reducing cost
- Built-in Slope Compensation function, avoiding subharmonic oscillation
- Built-in Auto Standby function (Input Power,  $P_{IN} < 30$  mW at no load)
  - Normal operation: PWM mode
  - Light load operation: Standby mode (burst oscillation)
- Built-in Audible Noise Suppression function during Standby mode
- Built-in Startup Circuit, reducing power consumption in standby operation, and eliminating external components.
- Bias-Assist function, improving startup operation, suppressing  $V_{CC}$  voltage drop in operation, and allowing use of smaller  $V_{CC}$  capacitor
- Built-in Leading Edge Blanking function

*Continued on the next page...*

**Package: 6-Pin fully molded TO-220F-6L (FM207)**



*Not to scale*

**Description**

The STR-W605xS series are power ICs for switching power supplies, incorporating a power MOSFET and a current mode PWM controller IC. Including a startup circuit and a standby function in the controller, the product achieves low power consumption, low standby power, and high cost-effectiveness power supply systems with few external components.

The STR-W605xS internal MOSFET has a  $V_{DSS}$  of 650 V (min), and an  $R_{DS(on)}$  of 1.9  $\Omega$  (max) to 3.95  $\Omega$  (max) with a frequency of 67 kHz. Power output is rated at 45 to 90 W at 230 VAC input and 30 to 60 W at wide input range (85 to 265 VAC).

The device is provided in an industry-standard TO-220 package, with heatsink mounting flange and pin 2 removed for increased supply isolation.

**Applications:**

For switching power supplies used in:

- White goods
- Consumer electronics
- Office automation
- Industrial equipment
- Communication equipment

### Typical Application

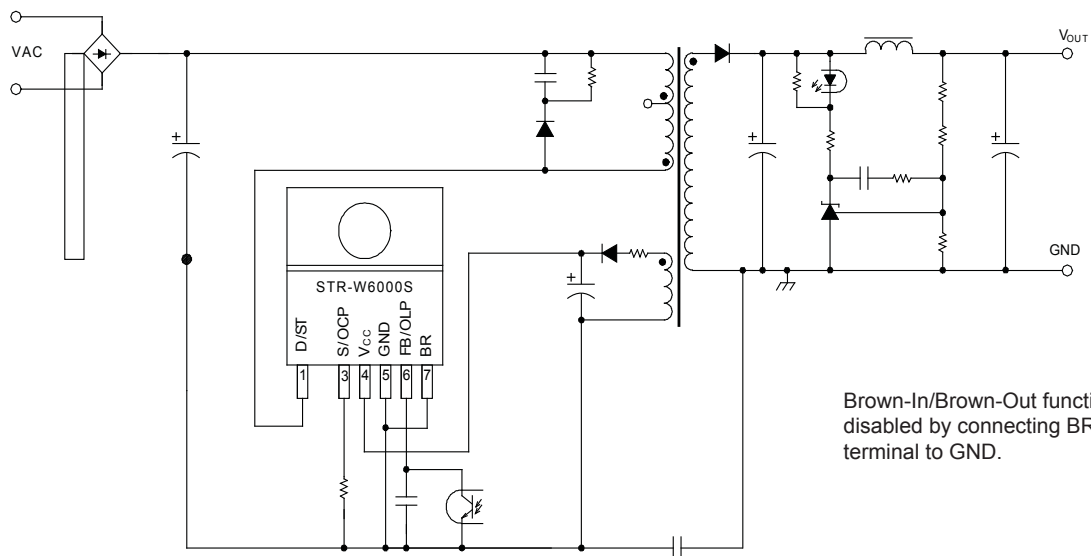

Brown-In/Brown-Out function disabled by connecting BR terminal to GND.

**Features and Benefits (continued)**

- Two-chip structure, with a controller and a power MOSFET with guaranteed avalanche energy available to simplify surge absorber circuits
- Protection functions:
  - Brown-In and Brown-Out Protection function: auto-restart, prevention of excess input current and heat rise at low input voltage
  - Overcurrent Protection function (OCP): pulse-by-pulse built-in compensation circuit to minimize OCP point variation on AC input voltage
  - Overload Protection function (OLP): auto-restart, built-in timer, reduces heat during overload condition, and no external components required
  - Overvoltage Protection function (OVP): Auto-restart
  - Thermal Shutdown Protection function (TSD): Auto-restart

**Selection Guide**

Part Number	f <sub>osc</sub> (kHz)	MOSFET V <sub>DSS(min)</sub> (V)	R <sub>DS(on)</sub> (max) (Ω)	P <sub>out</sub> * (W)		Package	Packing
				230 V	Wide		
STR-W6051S	67	650	3.95	45	30	TO-220F-6L (Sanken FM207) with pin 2 removed	50 pieces per tube
STR-W6052S			2.8	60	40		
STR-W6053S			1.9	90	60		

\* The listed output power is based on the package thermal ratings, and the peak output power can be 120% to 140% of the value stated here. At low output voltage and short duty cycle, the output power may be less than the value stated here.

**Absolute Maximum Ratings**<sup>1</sup> Valid at  $T_A = 25^\circ\text{C}$ , unless otherwise specified

Characteristic	Symbol	Notes	Terminals	Rating	Unit	
Drain Peak Current <sup>2</sup>	$I_{Dpeak}$	Single pulse	STR-W6051S	1 – 3	5.0	A
			STR-W6052S	1 – 3	7.0	A
			STR-W6053S	1 – 3	9.5	A
Maximum Switching Current <sup>3</sup>	$I_{Dmax}$	$T_A = -20^\circ\text{C}$ to $125^\circ\text{C}$	STR-W6051S	1 – 3	5.0	A
			STR-W6052S	1 – 3	7.0	A
			STR-W6053S	1 – 3	9.5	A
Single Pulse Avalanche Energy <sup>4</sup>	$E_{AS}$	Single pulse, $V_{DD} = 99\text{ V}$ , $L = 20\text{ mH}$	STR-W6051S	1 – 3	47	mJ
			STR-W6052S	1 – 3	62	mJ
			STR-W6053S	1 – 3	86	mJ
	$I_{Lpeak}$	Single pulse, $V_{DD} = 99\text{ V}$ , $L = 20\text{ mH}$	STR-W6051S	1 – 3	2.0	A
			STR-W6052S	1 – 3	2.3	A
			STR-W6053S	1 – 3	2.7	A
S/OCP Terminal Voltage	$V_{OCP}$			3 – 5	-2 to 6	V
Controller IC (MIC) Supply Input Voltage	$V_{CC}$			4 – 5	32	V
FB/OLP Terminal Voltage	$V_{FB}$			6 – 5	-0.3 to 14	V
FB/OLP Terminal Sink Current	$I_{FB}$			6 – 5	1.0	mA
BR Terminal Voltage	$V_{BR}$			7 – 5	-0.3 to 7	V
BR Terminal Sink Current	$I_{BR}$			7 – 5	1.0	mA
MOSFET Power Dissipation <sup>5</sup>	$P_{D1}$	With infinite heatsink	STR-W6051S	1 – 3	22.3	W
			STR-W6052S	1 – 3	23.6	W
			STR-W6053S	1 – 3	26.5	W
		Without heatsink		1 – 3	1.3	W
Controller IC (MIC) Power Dissipation	$P_{D2}$	Specified by $V_{CC} \times I_{CC}$		4 – 5	0.13	W
Internal Frame Temperature in Operation	$T_F$			–	-20 to 115	$^\circ\text{C}$
Operating Ambient Temperature	$T_{OP}$	Maximum recommended internal leadframe temperature, $T_F(\text{max}) = 105^\circ\text{C}$		–	-20 to 115	$^\circ\text{C}$
Storage Temperature	$T_{stg}$			–	-40 to 125	$^\circ\text{C}$
Channel Temperature	$T_{ch}$			–	150	$^\circ\text{C}$

<sup>1</sup>Current characteristics are defined based on IC as sink (+), or source (-).

<sup>2</sup>Refer to MOSFET Safe Operating Area Curve.

<sup>3</sup> $I_{Dmax}$  is the drain current on the D/ST pin determined by the drive voltage of the IC and the threshold voltage,  $V_{th}$ , of the MOSFET.

<sup>4</sup>Refer to MOSFET Avalanche Energy Derating Coefficient Curve.

<sup>5</sup>Refer to MOSFET Temperature versus Power Dissipation Curve.

**Functional Block Diagram**

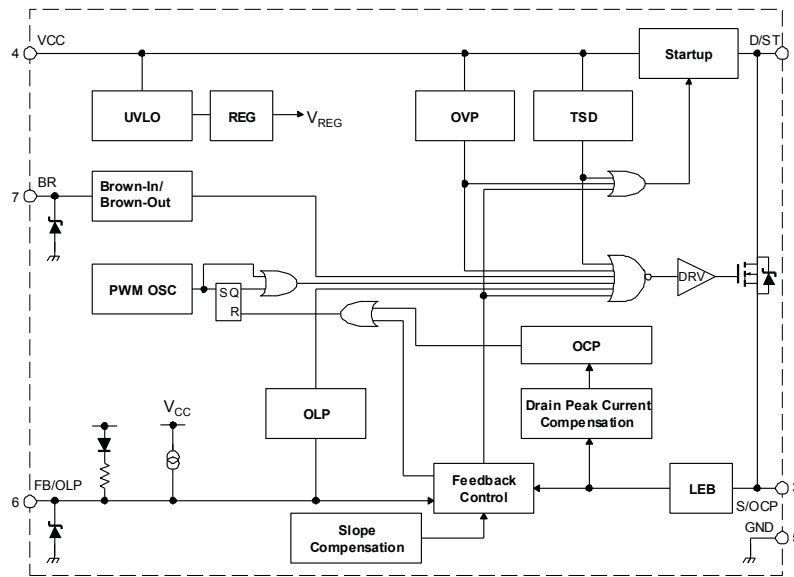

**Pin-out Diagram**

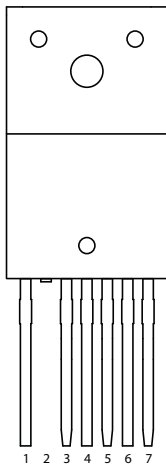

**Terminal List Table**

Number	Name	Function
1	D/ST	MOSFET drain, and input for startup current
2	–	(Pin removed)
3	S/OCP	MOSFET source, and input for Overcurrent Protection detection signal
4	V <sub>CC</sub>	Input for power supply for control circuit
5	GND	Ground
6	FB/OLP	Input for constant voltage control signal, and input for Overload Protection signal
7	BR	Input for Brown-In and Brown-Out Protection detection voltage

**Electrical Characteristics**<sup>1</sup> Valid at  $V_{CC} = 18\text{ V}$ ,  $T_A = 25^\circ\text{C}$ , unless otherwise specified

Characteristic	Symbol	Terminal	Min.	Typ.	Max.	Unit
Operation Start Voltage	$V_{CC(ON)}$	4 – 5	13.8	15.3	16.8	V
Operation Stop Voltage <sup>2</sup>	$V_{CC(OFF)}$	4 – 5	7.3	8.1	8.9	V
Circuit Current in Operation	$I_{CC(ON)}$	4 – 5	–	–	2.5	mA
Minimum Startup Voltage	$V_{ST(ON)}$	4 – 5	–	40	–	V
Startup Current	$I_{STARTUP}$	4 – 5	–3.9	–2.5	–1.1	mA
Startup Current Supply Threshold Voltage <sup>2</sup>	$V_{CC(BIAS)}$	4 – 5	8.5	9.5	10.5	V
Average Switching Frequency	$f_{OSC(av)}$	1 – 5	60	67	74	kHz
Switching Frequency Variance Range	$\Delta f$	1 – 5	–	5	–	kHz
Maximum Duty Cycle	$D_{MAX}$	1 – 5	63	71	79	%
Leading Edge Blanking Time	$t_{BW}$	–	–	390	–	ns
OCP Compensation Coefficient	$D_{PC}$	–	–	18	–	mV/ $\mu\text{s}$
Maximum Duty Cycle for OCP Compensation	$D_{DPC}$	–	–	36	–	%
OCP Threshold Voltage at Zero Duty Cycle	$V_{OCP(L)}$	3 – 5	0.70	0.78	0.86	V
OCP Threshold Voltage at 36% Duty Cycle	$V_{OCP(H)}$	3 – 5	0.79	0.88	0.97	V
Maximum Feedback Current	$I_{FB(MAX)}$	6 – 5	–340	–230	–150	$\mu\text{A}$
Minimum Feedback Current	$I_{FB(MIN)}$	6 – 5	–30	–15	–7	$\mu\text{A}$
Oscillation Stop FB/OLP Voltage	$V_{FB(OFF)}$	6 – 5	0.85	0.95	1.05	V
OLP Threshold Voltage	$V_{FB(OLP)}$	6 – 5	7.3	8.1	8.9	V
Operation Current After OLP	$I_{CC(OLP)}$	4 – 5	–	300	–	$\mu\text{A}$
OLP Delay Time	$t_{OLP}$	1 – 5	54	68	82	ms
FB/OLP Terminal Clamp Voltage	$V_{FB(CLAMP)}$	6 – 5	11	12.8	14	V
Brown-In Threshold Voltage	$V_{BR(IN)}$	7 – 5	5.2	5.6	6	V
Brown-Out Threshold Voltage	$V_{BR(OUT)}$	7 – 5	4.45	4.8	5.15	V
BR Terminal Clamp Voltage	$V_{BR(CLAMP)}$	7 – 5	6	6.4	7	V
BR Function Disabling Threshold	$V_{BR(DIS)}$	7 – 5	0.3	0.48	0.7	V
OVP Threshold Voltage	$V_{CC(OVP)}$	4 – 5	26	29	32	V
Thermal Shutdown Operating Temperature	$T_{J(TSD)}$	–	130	–	–	$^\circ\text{C}$

<sup>1</sup>Current characteristics are defined based on IC as sink (+), or source (–).

<sup>2</sup> $V_{CC(BIAS)} > V_{CC(OFF)}$ .

**MOSFET Electrical Characteristics** Valid at  $T_A = 25^\circ\text{C}$ , unless otherwise specified

Characteristic	Symbol	Device	Terminal	Min.	Typ.	Max.	Unit
Drain-to-Source Breakdown Voltage	$V_{DSS}$	–	1 – 3	650	–	–	V
Drain Leakage Current	$I_{DSS}$	–	1 – 3	–	–	300	$\mu\text{A}$
On-Resistance	$R_{DS(on)}$	STR-W6051S	1 – 3	–	–	3.95	$\Omega$
		STR-W6052S	1 – 3	–	–	2.8	$\Omega$
		STR-W6053S	1 – 3	–	–	1.9	$\Omega$
Switching Time	$t_f$	–	1 – 3	–	–	250	ns
Thermal Resistance*	$R_{\theta chF}$	STR-W6051S	–	–	–	2.63	$^\circ\text{C/W}$
		STR-W6052S	–	–	–	2.26	$^\circ\text{C/W}$
		STR-W6053S	–	–	–	1.95	$^\circ\text{C/W}$

\*Between channel and internal frame.

Characteristic Performance  
STR-W6051S

S. O. A. Temperature Derating Coefficient Curve

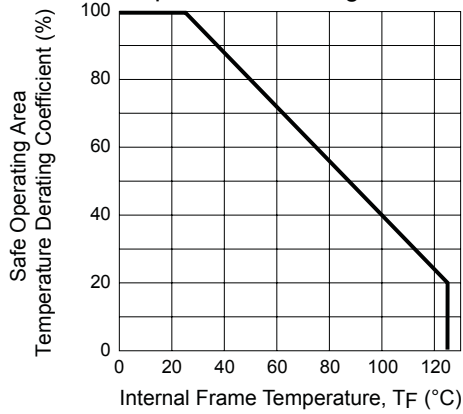

MOSFET Safe Operating Area Curve

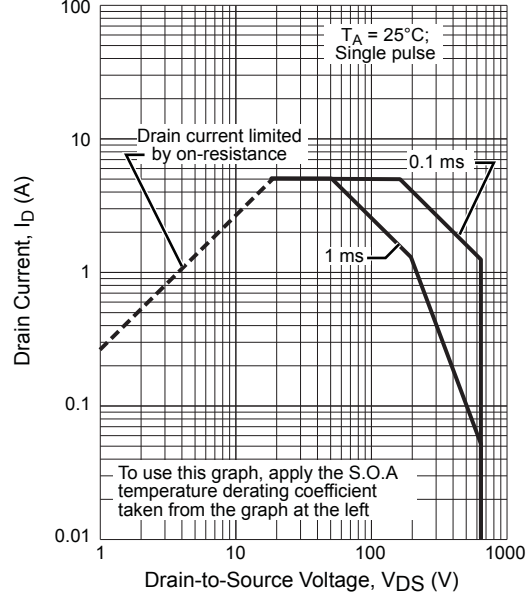

MOSFET Avalanche Energy Derating Coefficient Curve

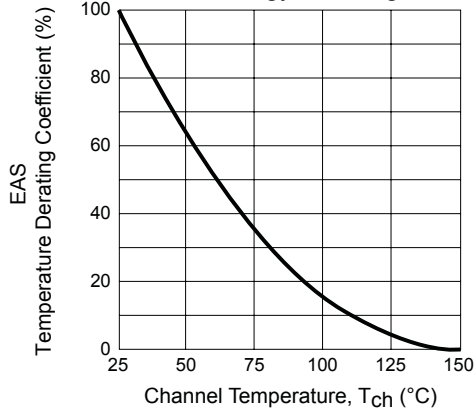

MOSFET Temperature versus Power Dissipation Curve

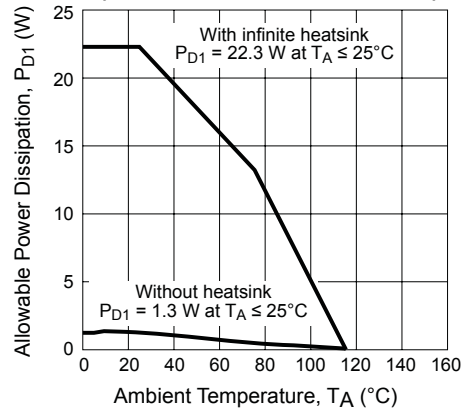

Transient Thermal Resistance Curve

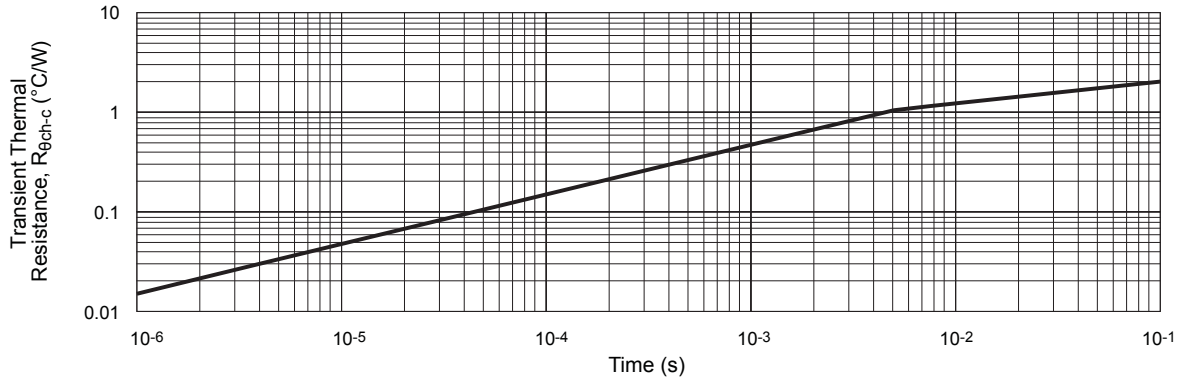

Characteristic Performance  
STR-W6052S

S. O. A. Temperature Derating Coefficient Curve

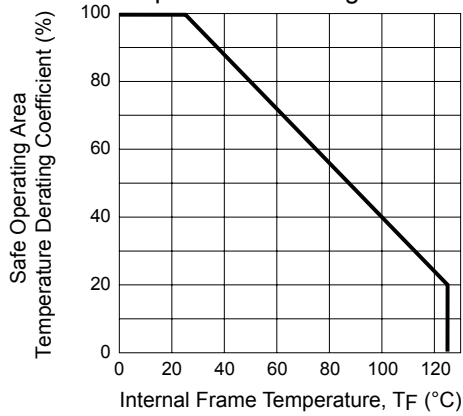

MOSFET Safe Operating Area Curve

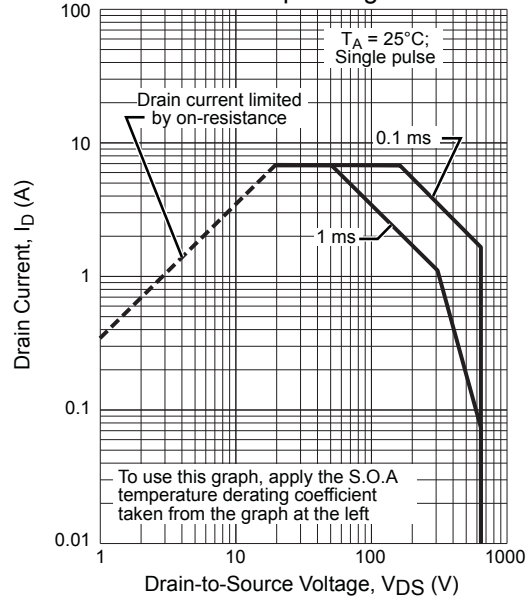

MOSFET Avalanche Energy Derating Coefficient Curve

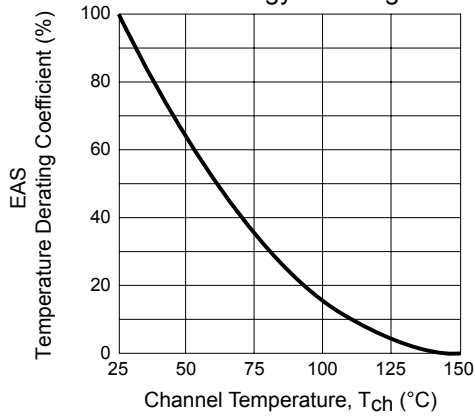

MOSFET Temperature versus Power Dissipation Curve

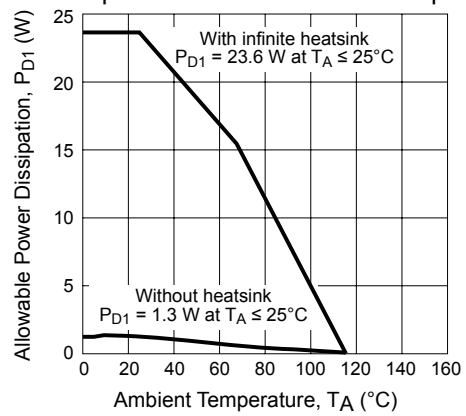

Transient Thermal Resistance Curve

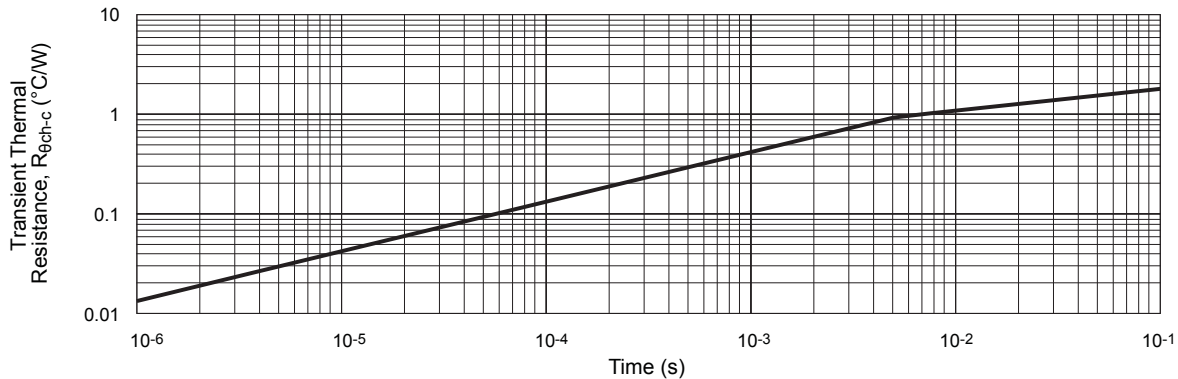

Characteristic Performance  
STR-W6053S

S. O. A. Temperature Derating Coefficient Curve

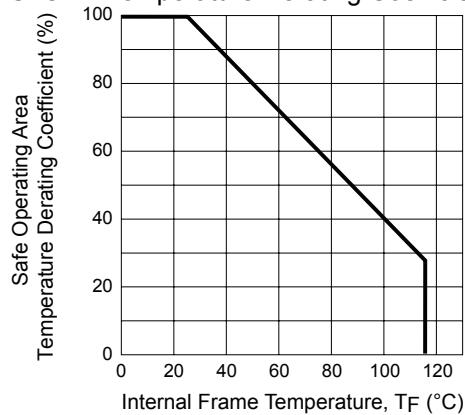

MOSFET Safe Operating Area Curve

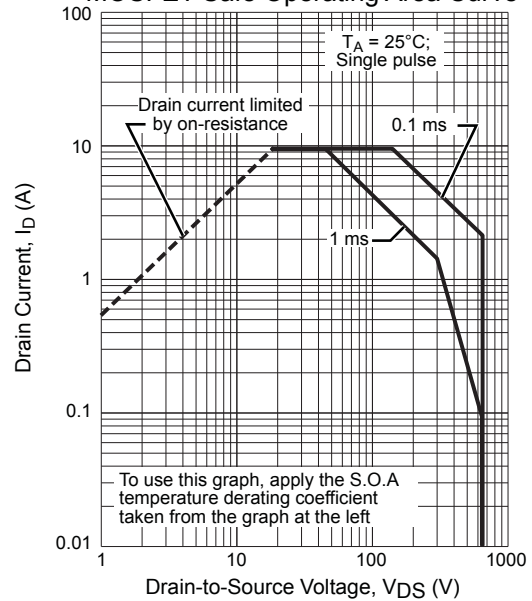

MOSFET Avalanche Energy Derating Coefficient Curve

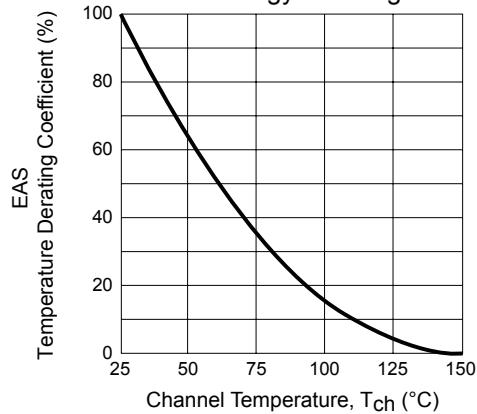

MOSFET Temperature versus Power Dissipation Curve

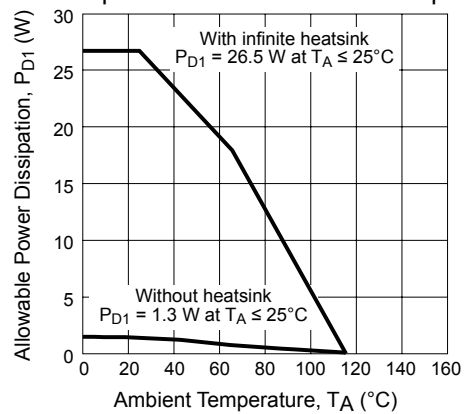

Transient Thermal Resistance Curve

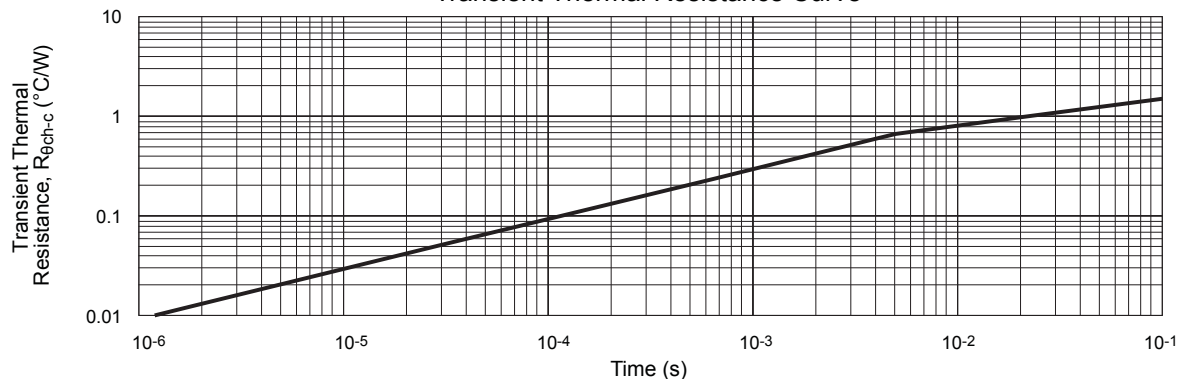



**Typical Application**

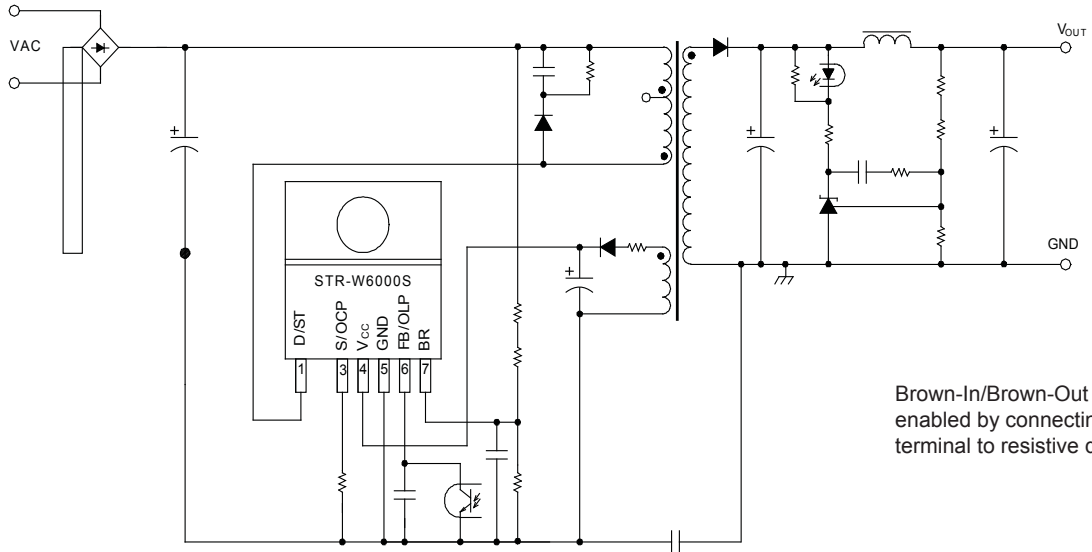

Brown-In/Brown-Out function enabled by connecting BR terminal to resistive divider.

Package Outline Drawing, TO-220F-6L (FM207)

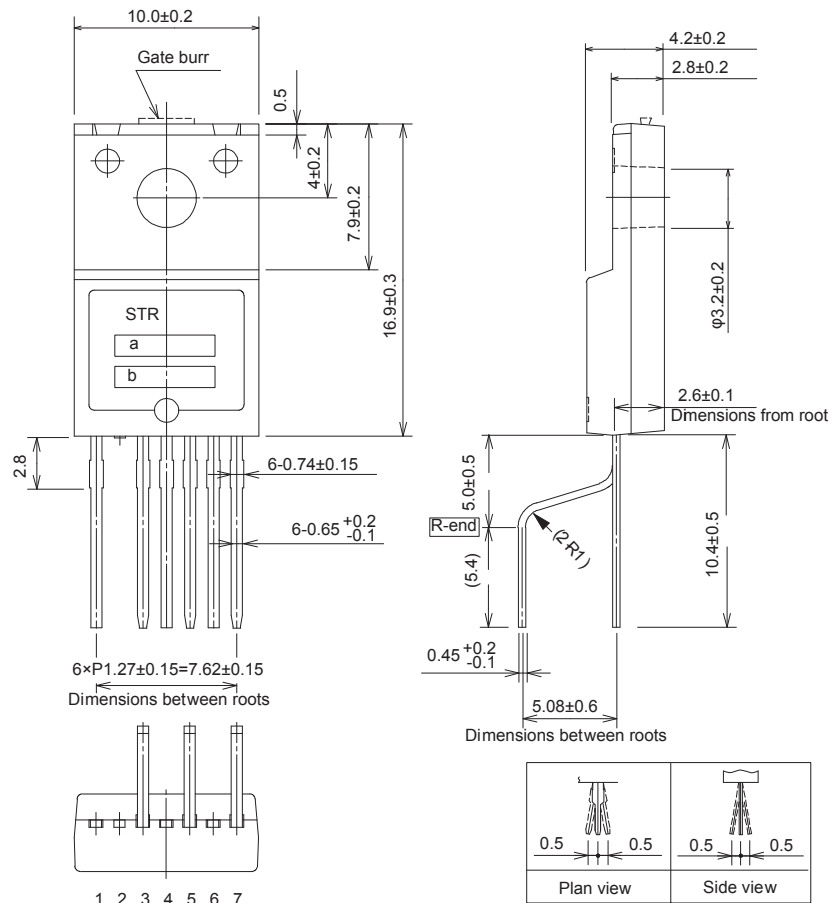

Leadform: 2003

Material of terminal: Cu  
Treatment of terminal: Solder plating (Pb-free)  
Weight: Approximately 2.3 g  
Dashed line at Gate Burr indicates  
protrusion of 0.3 mm (max)  
Unit: mm

- a. Type Number: W6051S  
b. Lot Number:  
1<sup>st</sup> letter: Last digit of year  
2<sup>nd</sup> letter: Month  
1 to 9 for Jan. to Sept.  
O for Oct.  
N for Nov.  
D for Dec.  
3<sup>rd</sup> and 4<sup>th</sup> letter: Day of month  
5<sup>th</sup> letter: Sanken Registration Number

Leadframe plating Pb-free. Device composition  
compliant with the RoHS directive.

**Packing Specifications**

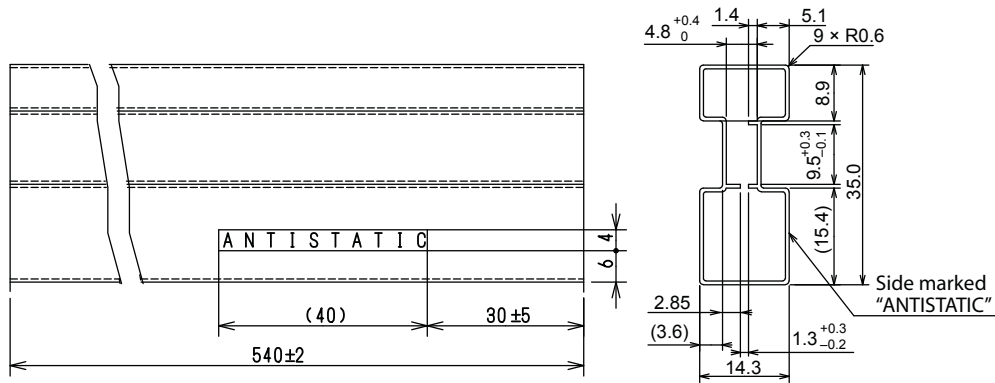

Tube dimensions (mm)

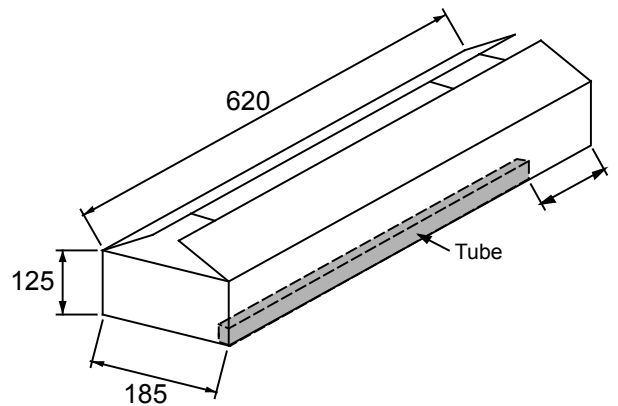
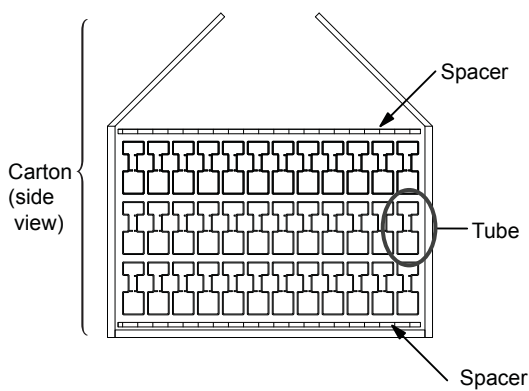

Carton dimensions (mm)

Capacity:  
 36 tubes per carton (3 rows, 12 tubes per row)  
 50 pieces per tube  
 1800 pieces maximum per carton

Because reliability can be affected adversely by improper storage environments and handling methods, please observe the following cautions.

**Cautions for Storage**

- Ensure that storage conditions comply with the standard temperature (5°C to 35°C) and the standard relative humidity (around 40% to 75%); avoid storage locations that experience extreme changes in temperature or humidity.
- Avoid locations where dust or harmful gases are present and avoid direct sunlight.
- Reinspect for rust on leads and solderability of products that have been stored for a long time.

**Cautions for Testing and Handling**

When tests are carried out during inspection testing and other standard test periods, protect the products from power surges from the testing device, shorts between the product pins, and wrong connections.

**Remarks About Using Silicone Grease with a Heatsink**

- When silicone grease is used in mounting this product on a heatsink, it shall be applied evenly and thinly. If more silicone grease than required is applied, it may produce excess stress.
- Volatile-type silicone greases may crack after long periods of time, resulting in reduced heat radiation effect. Silicone grease with low consistency (hard grease) may cause cracks in the mold resin when screwing the product to a heatsink.
- Our recommended silicone greases for heat radiation purposes, which will not cause any adverse effect on the product life, are indicated below:

Type	Suppliers
G746	Shin-Etsu Chemical Co., Ltd.
YG6260	Momentive Performance Materials Holding, Inc.
SC102	Dow Corning Toray Co., Ltd.

**Soldering**

- Leadframe temperature,  $T_F$ , should not exceed 115°(max)
- When soldering the products, please be sure to minimize the working time, within the following limits:  
260±5°C 10 s  
350±5°C 3 s (solder iron)
- To avoid an internal chip damaged, soldering on each of lead-pins should be at a distance of at least 2 mm away from the body of the products

**Assembly**

- Recommended screw torque through the mounting tab is 0.588 to 0.785 N • m (6 to 8 kgf • cm).

**Electrostatic Discharge**

- When handling the products, the operator must be grounded. Grounded wrist straps worn should have at least 1 MΩ of resistance from the operator to ground to prevent shock hazard, and it should be placed near the operator.
- Workbenches where the products are handled should be grounded and be provided with conductive table and floor mats.
- When using measuring equipment such as a curve tracer, the equipment should be grounded.
- When soldering the products, the head of soldering irons or the solder bath must be grounded in order to prevent leak voltages generated by them from being applied to the products.
- The products should always be stored and transported in SanKen shipping containers or conductive containers, or be wrapped in aluminum foil.