



STV9380A

Class-D vertical deflection amplifier for 2.5 Amp TV and monitor applications

Features

- High-efficiency power amplifier
- No heatsink
- Split supply
- Internal flyback generator
- Output current up to 2.5 A_{PP}
- Suitable for DC-coupling applications
- Few external components
- Protection against low V_{CC}

Description

Designed for TV and monitor applications, the STV9380A is a class-D vertical deflection booster assembled in a 20-pin plastic DIP package.

It operates with supplies up to ± 18 V and provides an output current up to 2.5 A_{PP} to drive the yoke. The internal flyback generator avoids the need for an extra power supply.

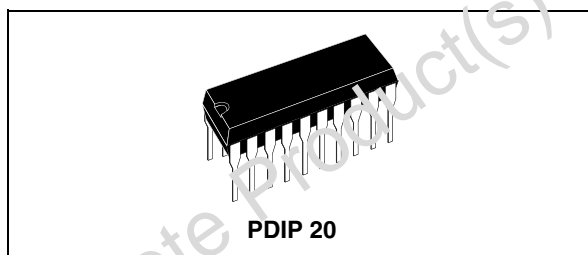

Figure 1. STV9380A pinout

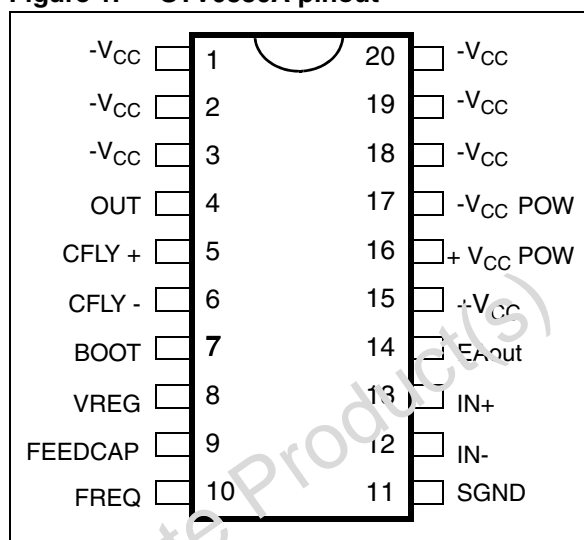

Table 1. Device summary

Order code	Packaging
STV9380A	Tray

1	Pin functions	3
2	Functional description	3
3	Absolute maximum ratings	5
4	Thermal data	6
5	Electrical characteristics	6
6	I/O waveforms	7
7	Package mechanical data	9
	7.1 Environmentally-friendly packages	10
8	Revision history	11

1 Pin functions

Table 2. Pin descriptions

Pin	Name	Function	Pin	Name	Function
1	-V _{CC}	Negative supply	11	SGND	Signal ground
2	-V _{CC}	Negative supply	12	IN-	Error amplifier inverting input
3	-V _{CC}	Negative supply	13	IN+	Error amplifier non-inverting input
4	OUT	PWM output	14	EA out	Error amplifier output
5	CFLY+	Flyback capacitor	15	+V _{CC}	Positive supply
6	CFLY-	Flyback capacitor	16	+V _{CC} POW	Positive power supply
7	BOOT	Bootstrap capacitor	17	-V _{CC} POW	Negative power supply
8 ⁽¹⁾	VREG	Internal voltage regulator	18	-V _{CC}	Negative supply
9	FEEDCAP	Feed-back Integrating capacitor	19	-V _{CC}	Negative supply
10	FREQ	Frequency setting resistor	20	-V _{CC}	Negative supply

1. The voltage reference, accessible on pin 8, is for internal use only. No additional components should be connected to this pin except the decoupling capacitor.

2 Functional description

The STV9380A is a vertical deflection circuit operating in class-D. Class-D is a modulation method where the output transistors work in switching mode at high frequency. The output signal is restored by filtering the output square wave with an external LC filter. The major interest of this IC is the comparatively low power dissipation in regards to traditional amplifiers operating in class AB, eliminating the need of an heatsink.

Except for the output stage which uses class-D modulation, the circuit operation is similar to the one of a traditional linear vertical amplifier.

A (sawtooth) reference signal has to be applied to the circuit which can accept a differential or single ended signal. This sawtooth is amplified and applied as a current to the deflection yoke. This current is measured by means of a low value resistor. The resulting voltage is used as a feedback signal to guarantee the conformity of the yoke current with the reference input signal.

The overvoltage necessary for a fast retrace is obtained with a chemical capacitor charged at the power supply voltage of the circuit. At the flyback moment, this capacitor is connected in series with the output stage power supply. This method, used for several years with the linear vertical boosters and called "internal flyback" or "flyback generator", avoids the need of an additional power supply, while reducing the flyback duration.

The circuit uses a BCD process that combines bipolar, CMOS and DMOS devices. The output stage is composed of low-R_{ON} N-channel DMOS transistors.

Figure 2. Test and application circuit diagram

* Deflection yoke characteristics: $R = 5.5 \text{ W}$, $L = 7 \text{ mH}$
 $f_{\text{VERT}} = 50 \text{ Hz}$

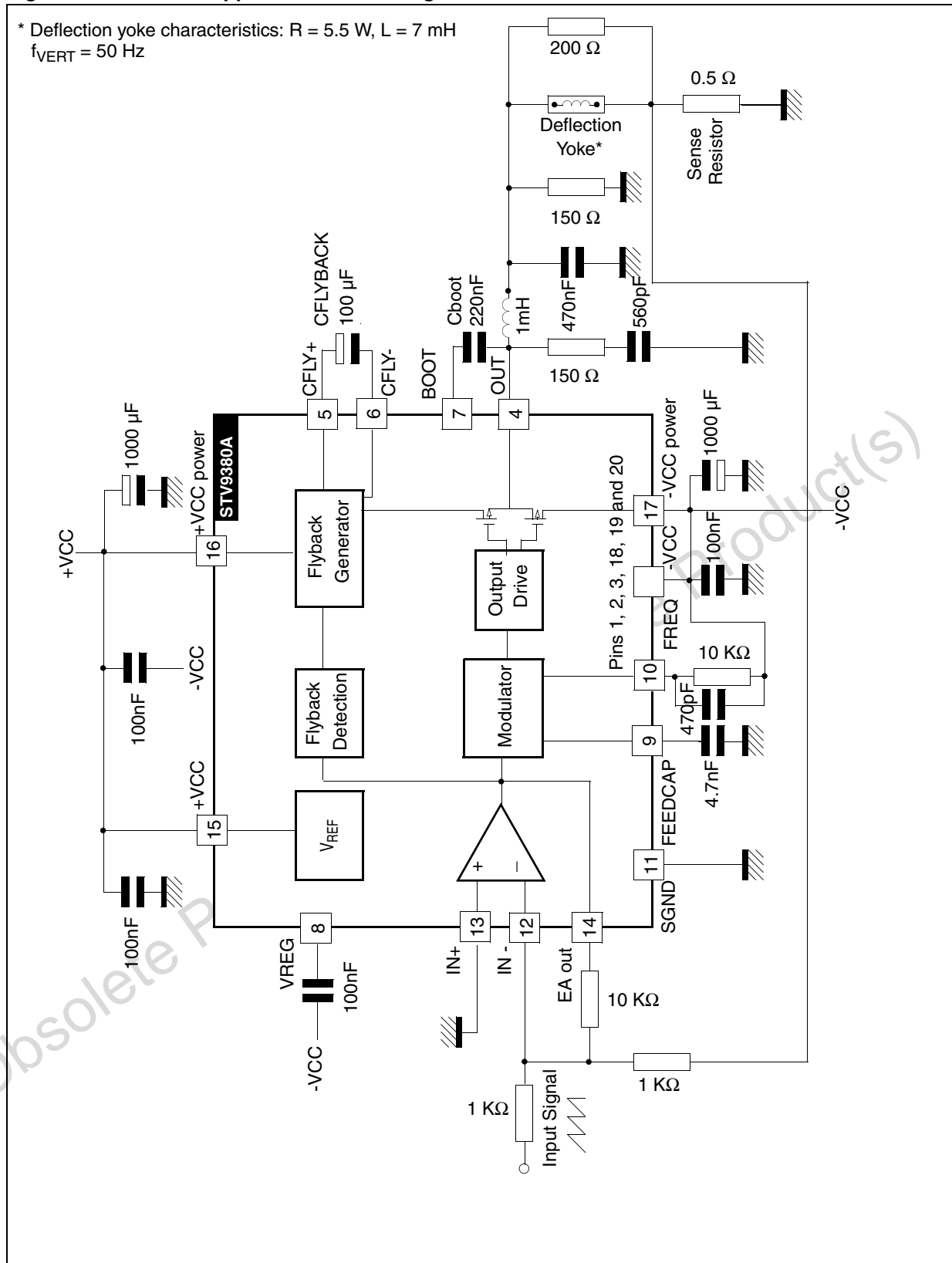
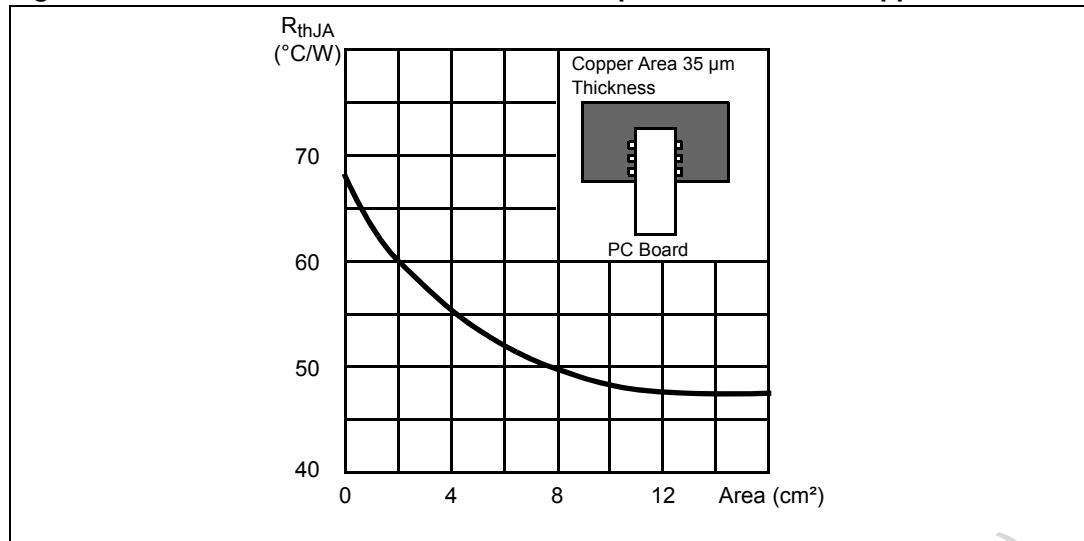

Figure 3. Thermal resistance with on-board square heatsink vs. copper area



3 Absolute maximum ratings

Table 3. Absolute maximum ratings

Symbol	Parameter	Value	Unit
V _{CC}	DC supply voltage	±20	V
T _{STG} , T _J	Storage and junction temperature	-40 to +150	°C
T _{OPER}	Operating temperature range	-20 to +120	°C
V _{ESD}	ESD susceptibility - human body model (100 pF discharge through 1.5 kΩ)	±2	kV
I _{OUT}	Output current	±1.6	A
V _{OUT}	Maximum output voltage (pin 4) with respect to -V _{CC} (pins 1, 2, 3, 18, 19 and 20) and during flyback ⁽¹⁾	80	V

1. During the flyback with V_{CC} = ±18 V, the maximum output voltage (pin 4) is close to 72 V, with respect to -V_{CC} (pins 1, 2, 3, 18, 19 and 20)

4 Thermal data

Table 4. Thermal data

Symbol	Parameter	Value	Unit
R_{thJA}	Junction-to-ambient thermal resistance	70	°C/W

Pins 1, 2, 3, 18, 19 and 20 are internally connected together and participate in heat evacuation.

5 Electrical characteristics

$T_{AMB} = 25^{\circ}\text{C}$, $V_{CC} = \pm 12\text{ V}$ and $f_{VERT} = 50\text{ Hz}$ unless otherwise specified (see [Figure 2](#)).

Table 5. Electrical characteristics

Symbol	Parameter	Test condition	Minimum	Typical	Maximum	Units
$+V_{CC}$	Positive supply range		+10		+18	V
$-V_{CC}$	Negative supply range		-18		-10	V
ΔV_{CC}	Maximum recommended difference between $+V_{CC}$ and $-V_{CC}$				± 4	V
$V_{CCSTAR T}$	Low V_{CC} detection			± 6.5		V
I_Q	Quiescent supply current	Input voltage = 0		14		mA
I_Y	Maximum vertical yoke current				± 1.25	A
I_{13}, I_{12}	Amplifier input bias current			-0.1		μA
V_{OS}	Output offset voltage	(1)	-50		+50	mV
SVR	Supply voltage rejection	(2)		82		dB
Fly_{THR}	Flyback detection threshold (positive slope)	V(14)		1.5		V
Fly_{THF}	Flyback detection threshold (negative slope)	V(14)		0.5		V
P_D	Integrated circuit dissipated power	(3)		1.1		W
f_{SW}	Switching frequency	$R_{FREQ} = 10\text{ k}\Omega$	120	140	160	kHz
f_{SW-OP}	Switching frequency operative range		100		200	kHz
R_{FREQ}	Frequency controller resistor range	Pin 10	7	10	14	$\text{k}\Omega$

- Input voltage = 0, measured after the filter (e.g. across the 470 nF filter capacitor)
- Supply rejection of the positive or negative power supply. V_{CC} ripple = 1 V_{PP}, f = 100 Hz, measured on the sense resistor.
- Power dissipated in the circuit in the case of the application from [Figure 2](#) and the current in the deflection yoke adjusted to 2.5 A_{PP}. The corresponding power dissipated in the vertical deflection yoke is 2.8 W.

6 I/O waveforms

The following waveforms are obtained with the schematic diagram given in [Figure 2](#).

Figure 4. Current in the deflection yoke (calibration: 0.5 A/div)

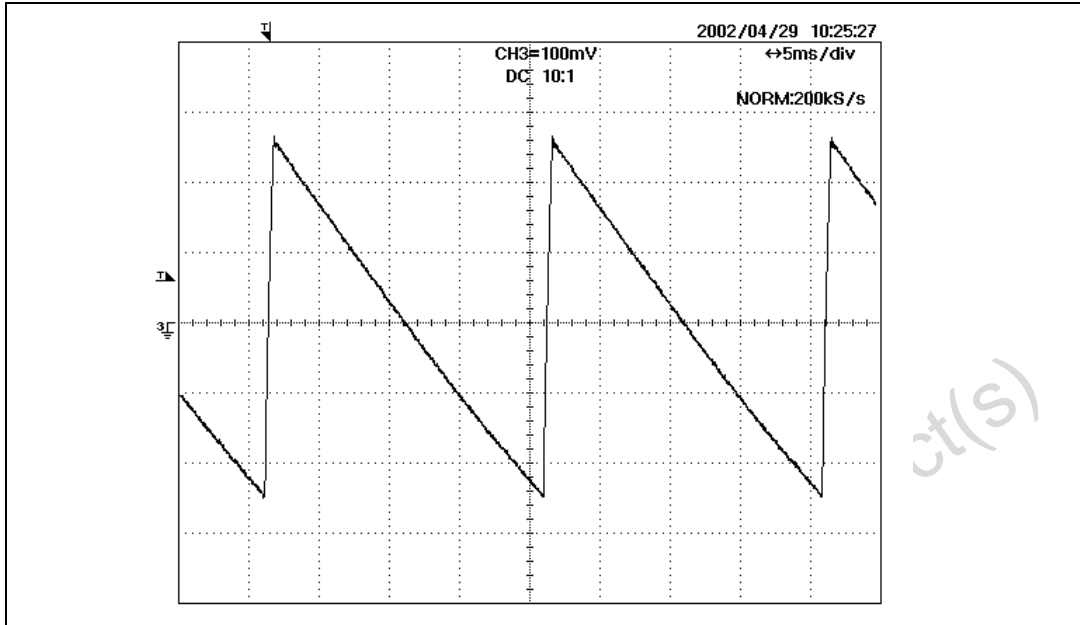

Figure 5. Current and voltage in the deflection yoke during flyback (calibration: 0.5 A/div, 10 V/div)

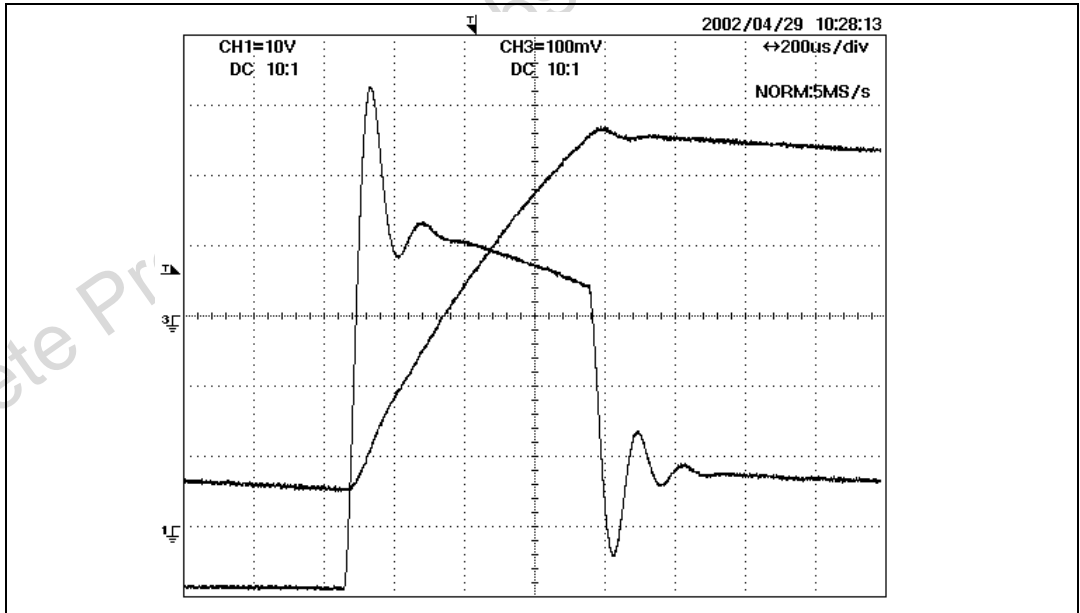

Figure 6. Current in the deflection yoke and voltage at the error amplifier output (pin 14) during flyback (calibration: 0.5 A/div, 1 V/div)

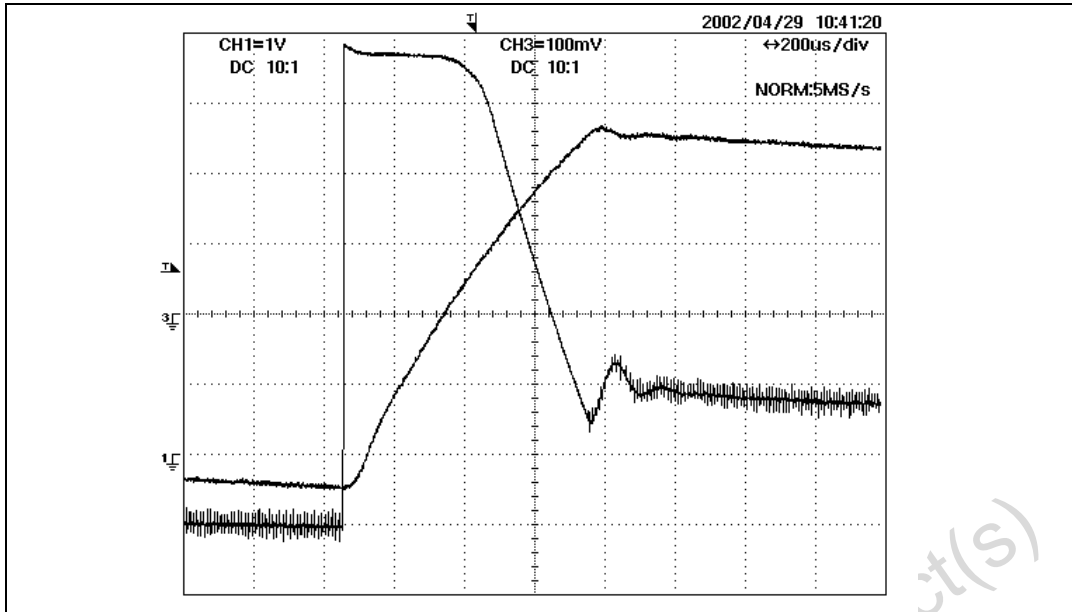
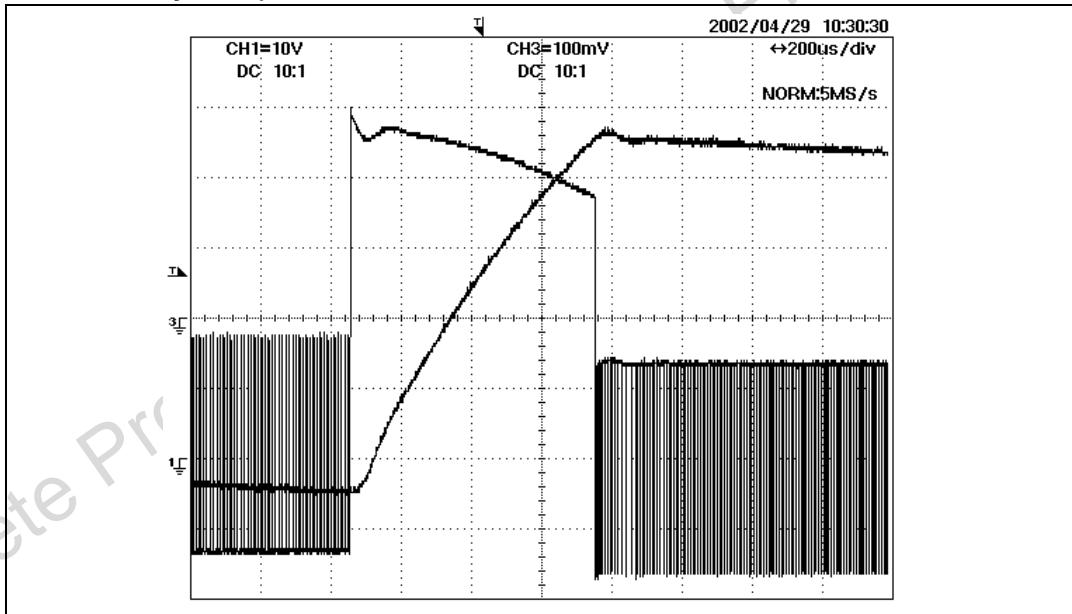

Figure 7. Current in the deflection yoke and voltage at the output (pin 4), during flyback (calibration: 0.5 A/div, 10 V/div)



7 Package mechanical data

Figure 8. 20-pin plastic dual in-line package, 300-mil width

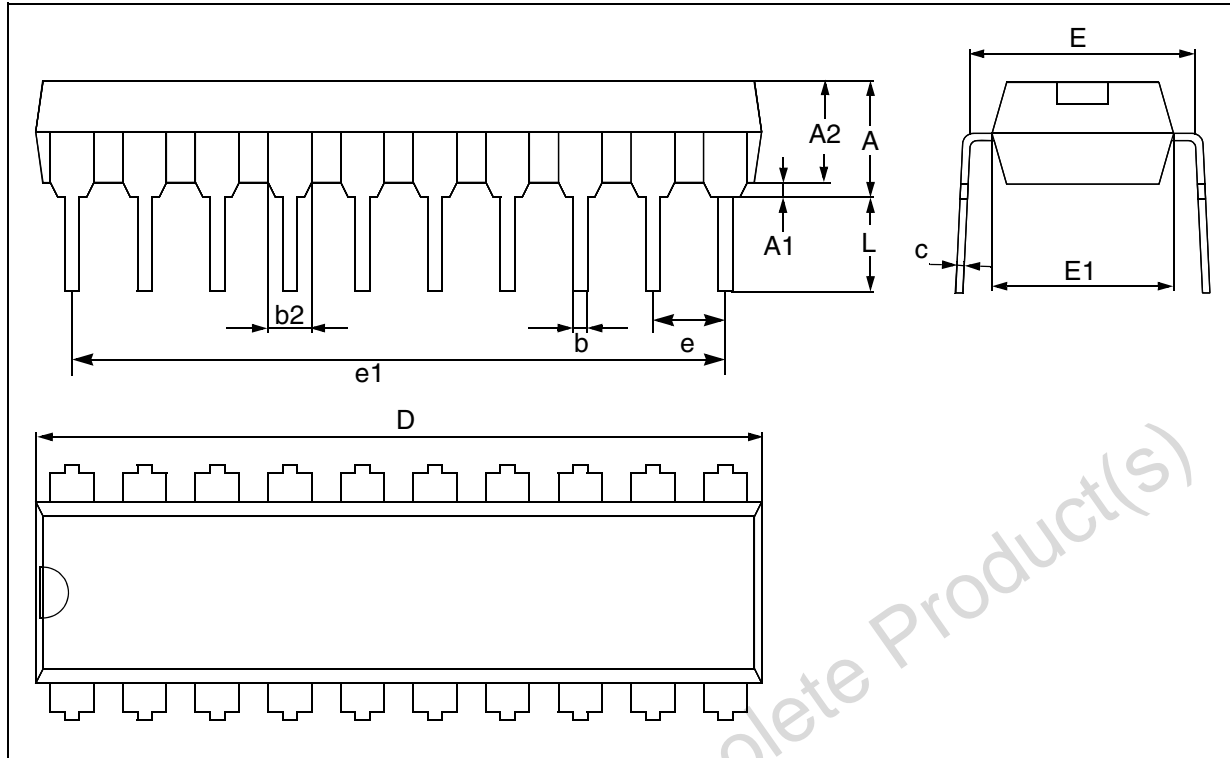

Table 6. JEDEC standard package dimensions

Dim.	Millimeters			Inches		
	Minimum	Typical	Maximum	Minimum	Typical	Maximum
A			5.33			0.210
A1	0.38			0.015		
A2	2.92	3.30	4.95	0.115	0.130	0.195
b	0.36	0.46	0.56	0.014	0.018	0.022
b2	1.14	1.52	1.78	0.045	0.060	0.070
c	0.20	0.25	0.36	0.008	0.010	0.014
D	24.89	26.16	26.92	0.980	1.030	1.060
E	7.62	7.87	8.26	0.300	0.310	0.325
E1	6.10	6.35	7.11	0.240	0.250	0.280
e		2.54			0.100	
e1		22.86			0.900	
L	2.92	3.30	3.81	0.115	0.130	0.150

7.1 Environmentally-friendly packages

In order to meet environmental requirements, ST offers these devices in different grades of ECOPACK® packages, depending on their level of environmental compliance.

ECOPACK specifications, grade definitions and product status are available at: www.st.com. ECOPACK is an ST trademark.

Figure 9. ESD protection structure

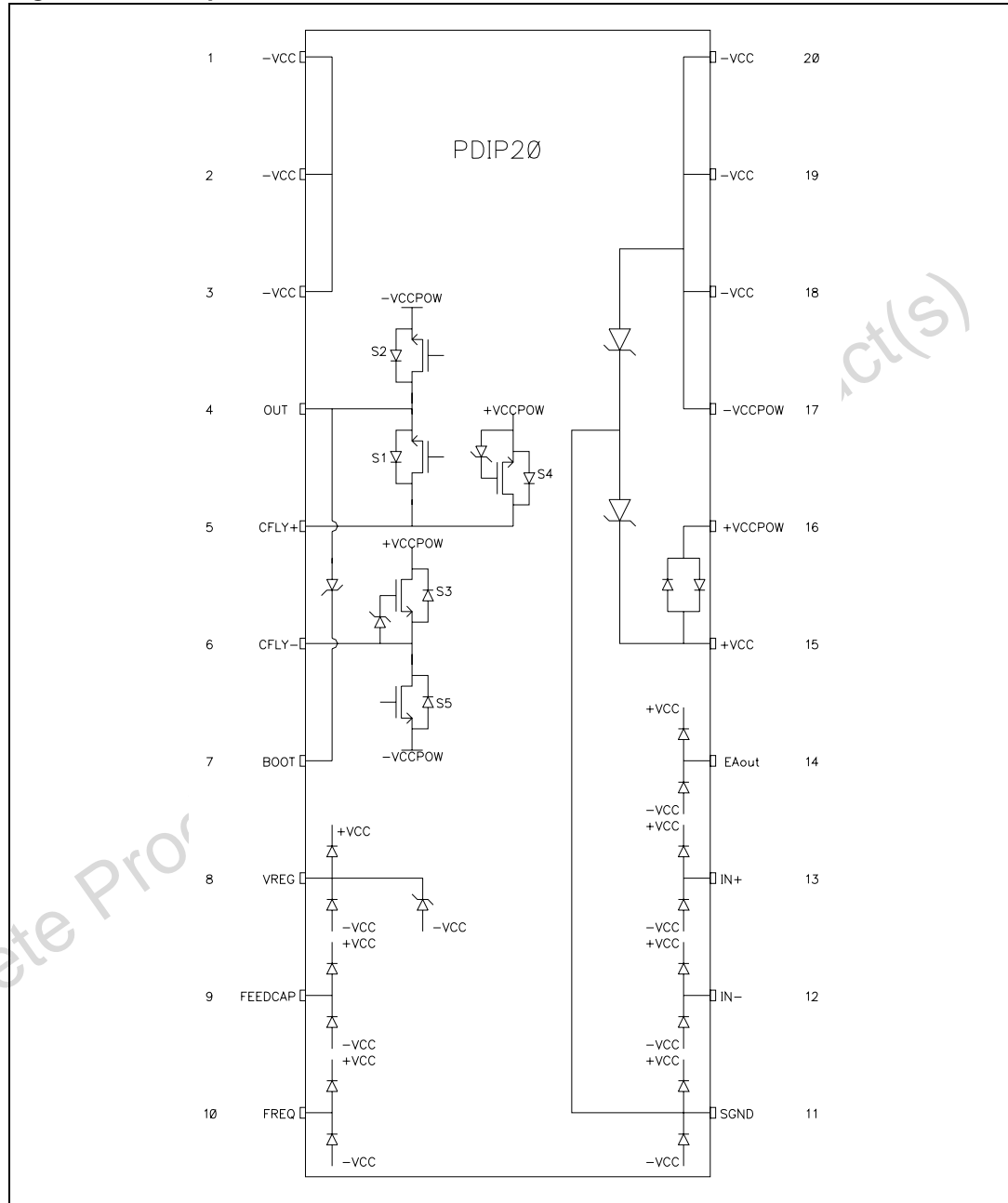

8 Revision history

Table 7. Document revision history

Date	Revision	Changes
May 2003	1	Initial release
24-Feb-2009	2	Preliminary banner removed, new template applied and Section 7.1 added

Obsolete Product(s) - Obsolete Product(s)

Please Read Carefully:

Information in this document is provided solely in connection with ST products. STMicroelectronics NV and its subsidiaries ("ST") reserve the right to make changes, corrections, modifications or improvements, to this document, and the products and services described herein at any time, without notice.

All ST products are sold pursuant to ST's terms and conditions of sale.

Purchasers are solely responsible for the choice, selection and use of the ST products and services described herein, and ST assumes no liability whatsoever relating to the choice, selection or use of the ST products and services described herein.

No license, express or implied, by estoppel or otherwise, to any intellectual property rights is granted under this document. If any part of this document refers to any third party products or services it shall not be deemed a license grant by ST for the use of such third party products or services, or any intellectual property contained therein or considered as a warranty covering the use in any manner whatsoever of such third party products or services or any intellectual property contained therein.

UNLESS OTHERWISE SET FORTH IN ST'S TERMS AND CONDITIONS OF SALE ST DISCLAIMS ANY EXPRESS OR IMPLIED WARRANTY WITH RESPECT TO THE USE AND/OR SALE OF ST PRODUCTS INCLUDING WITHOUT LIMITATION IMPLIED WARRANTIES OF MERCHANTABILITY, FITNESS FOR A PARTICULAR PURPOSE (AND THEIR EQUIVALENTS UNDER THE LAWS OF ANY JURISDICTION), OR INFRINGEMENT OF ANY PATENT, COPYRIGHT OR OTHER INTELLECTUAL PROPERTY RIGHT.

UNLESS EXPRESSLY APPROVED IN WRITING BY AN AUTHORIZED ST REPRESENTATIVE, ST PRODUCTS ARE NOT RECOMMENDED, AUTHORIZED OR WARRANTED FOR USE IN MILITARY, AIR CRAFT, SPACE, LIFE SAVING, OR LIFE SUSTAINING APPLICATIONS, NOR IN PRODUCTS OR SYSTEMS WHERE FAILURE OR MALFUNCTION MAY RESULT IN PERSONAL INJURY, DEATH, OR SEVERE PROPERTY OR ENVIRONMENTAL DAMAGE. ST PRODUCTS WHICH ARE NOT SPECIFIED AS "AUTOMOTIVE GRADE" MAY ONLY BE USED IN AUTOMOTIVE APPLICATIONS AT USER'S OWN RISK.

Resale of ST products with provisions different from the statements and/or technical features set forth in this document shall immediately void any warranty granted by ST for the ST product or service described herein and shall not create or extend in any manner whatsoever, any liability of ST.

ST and the ST logo are trademarks or registered trademarks of ST in various countries.

Information in this document supersedes and replaces all information previously supplied.

The ST logo is a registered trademark of STMicroelectronics. All other names are the property of their respective owners.

© 2009 STMicroelectronics - All rights reserved

STMicroelectronics group of companies

Australia - Belgium - Brazil - Canada - China - Czech Republic - Finland - France - Germany - Hong Kong - India - Israel - Italy - Japan - Malaysia - Malta - Morocco - Singapore - Spain - Sweden - Switzerland - United Kingdom - United States of America

www.st.com