

# TB2903HQ

## Maximum Power 47 W BTL × 4-ch Audio Power IC

The TB2903HQ is 4-ch BTL audio amplifier for car audio applications.

This IC can generate higher power:  $P_{OUT\ MAX} = 47\ W$  as it includes the pure complementary P-ch and N-ch DMOS output stage.

It is designed to yield low distortion ratio for 4-ch BTL audio power amplifier, built-in standby function, muting function, and various kinds of protectors.

Additionally, Off-set detector is built in.

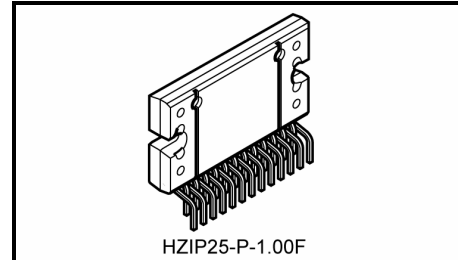

Weight: 7.7 g (typ.)

### Features

- High power output
  - :  $P_{OUT\ MAX} (1) = 47\ W$  (typ.)  
( $V_{CC} = 14.4\ V$ ,  $f = 1\ kHz$ , JEITA max,  $R_L = 4\ \Omega$ )
  - :  $P_{OUT\ MAX} (2) = 43\ W$  (typ.)  
( $V_{CC} = 13.7\ V$ ,  $f = 1\ kHz$ , JEITA max,  $R_L = 4\ \Omega$ )
  - :  $P_{OUT} (1) = 29\ W$  (typ.)  
( $V_{CC} = 14.4\ V$ ,  $f = 1\ kHz$ , THD = 10%,  $R_L = 4\ \Omega$ )
  - :  $P_{OUT} (2) = 25\ W$  (typ.)  
( $V_{CC} = 13.2\ V$ ,  $f = 1\ kHz$ , THD = 10%,  $R_L = 4\ \Omega$ )
- Low distortion ratio: THD = 0.015% (typ.)  
( $V_{CC} = 13.2\ V$ ,  $f = 1\ kHz$ ,  $P_{OUT} = 5\ W$ ,  $R_L = 4\ \Omega$ )
- Low noise:  $V_{NO} = 90\ \mu V_{rms}$  (typ.)  
( $V_{CC} = 13.2\ V$ ,  $R_g = 0\ \Omega$ , BW = 20 Hz~20 kHz,  $R_L = 4\ \Omega$ )
- Built-in standby switch function (pin 4)
- Built-in muting function (pin 22)
- Built-in Off-set detection function (pin 25)
- Built-in various protection circuits:
  - Thermal shut down, overvoltage, out to GND, out to  $V_{CC}$ , out to out short
- Operating supply voltage:  $V_{CC\ (opr)} = 9\sim 18\ V$  ( $R_L = 4\ \Omega$ )

Note 1: Since this device's pins have a low withstanding voltage, please handle it with care.

Note 2: Install the product correctly. Otherwise, it may result in break down, damage and/or degradation to the product or equipment.

Note 3: These protection functions are intended to avoid some output short circuits or other abnormal conditions temporarily. These protect functions do not warrant to prevent the IC from being damaged.  
In case of the product would be operated with exceeded guaranteed operating ranges, these protection features may not operate and some output short circuits may result in the IC being damaged.

## Block Diagram

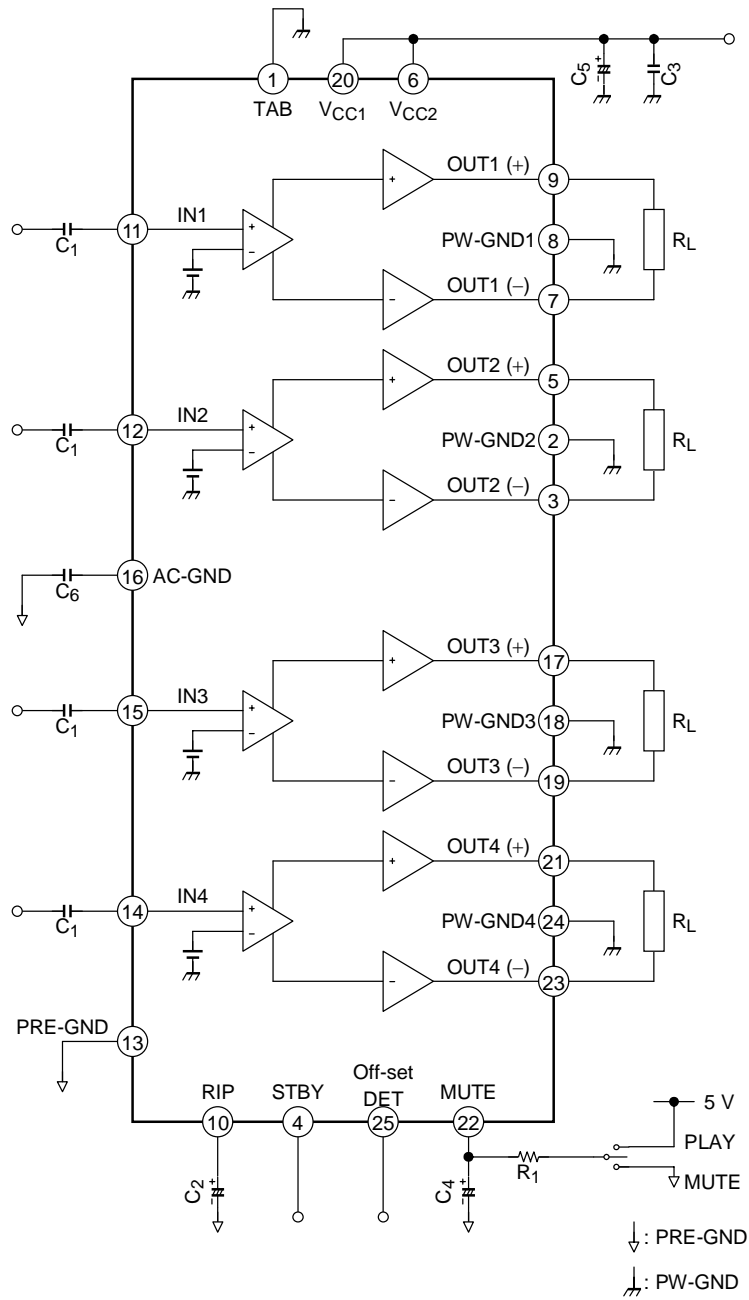

Note4: Some of the functional blocks, circuits, or constants in the block diagram may be omitted or simplified for explanatory purpose.

## Caution and Application Method

(Description is made only on the single channel.)

### 1. Voltage Gain Adjustment

This IC has no NF (negative feedback) Pins. Therefore, the voltage gain can not be adjusted, but it makes the device a space and total costs saver.

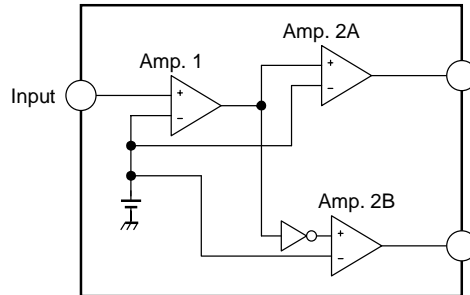

**Figure 1 Block Diagram**

The voltage gain of amp.1 :  $GV_1 = 0\text{dB}$

The voltage gain of amp.2A, B :  $GV_2 = 20\text{dB}$

The voltage gain of BTL connection:  $GV(\text{BTL}) = 6\text{dB}$

Therefore, the total voltage gain is decided by expression below.

$$GV = GV_1 + GV_2 + GV(\text{BTL}) = 0 + 20 + 6 = 26\text{dB}$$

### 2. Standby SW Function (pin 4)

By means of controlling pin 4 (standby pin) to High and Low, the power supply can be set to ON and OFF. The threshold voltage of pin 4 is set at about  $3V_{BE}$  (typ.), and the power supply current is about  $2\mu\text{A}$  (typ.) in the standby state.

#### Control Voltage of Pin 4: $V_{SB}$

Standby	Power	$V_{SB}$ (V)
ON	OFF	0~1.5
OFF	ON	3.5~6 V

When changing the time constant of pin 4, check the pop noise.

#### Advantage of Standby SW

- (1) Since  $V_{CC}$  can directly be controlled to ON or OFF by the microcomputer, the switching relay can be omitted.
- (2) Since the control current is microscopic, the switching relay of small current capacity is satisfactory for switching.

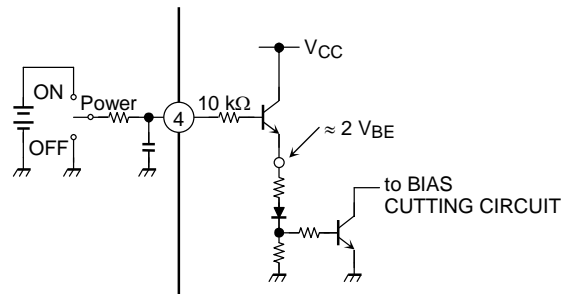

**Figure 2 With pin 4 set to High, Power is turned ON**

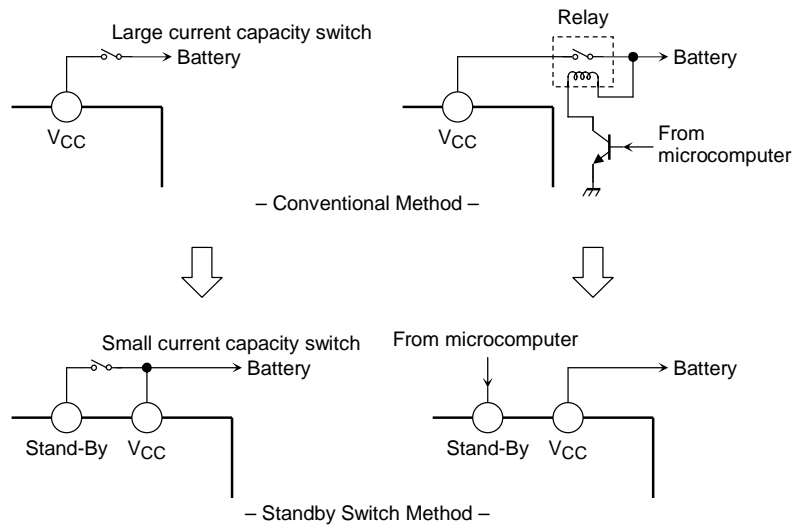

Figure 3

**3. Muting Function (pin 22)**

Audio muting function is enabled when pin 22 is Low. When the time constant of the muting function is determined by  $R_1$  and  $C_4$ , it should take into account the pop noise. The pop noise which is generated when the power or muting function is turned ON/OFF will vary according to the time constant. (Refer to Figure 4 and Figure 5.)

The pin 22 is designed to operate off 5 V.

Moreover, this terminal (pin 22) serves as the source switch of current of an internal mute circuit. And it is designed so that the discharge current of this terminal (pin 22) may serve as 200  $\mu$ A. The outside pull-up resistor  $R_1$  is determined on the basis of this value.

ex) When control voltage is changed in to 6 V from 5 V.

$$6 \text{ V} / 5 \text{ V} \times 47 \text{ k} = 56 \text{ k}$$

To obtain enough mute attenuation, a series resistor,  $R_1$  at pin 22 should be 47 k $\Omega$  or more.

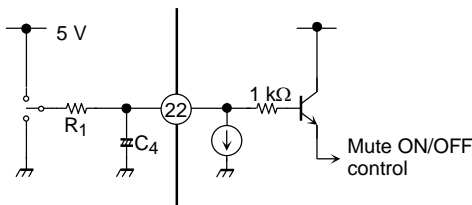

Figure 4 Muting Function

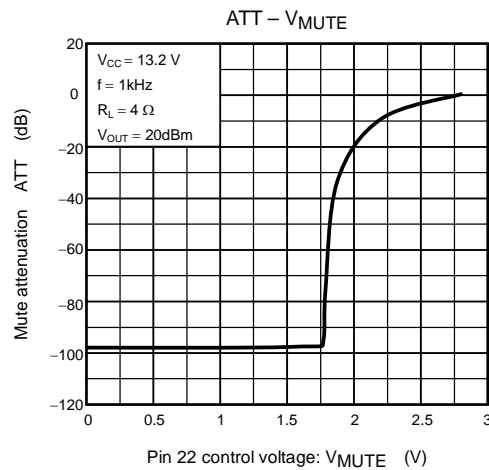
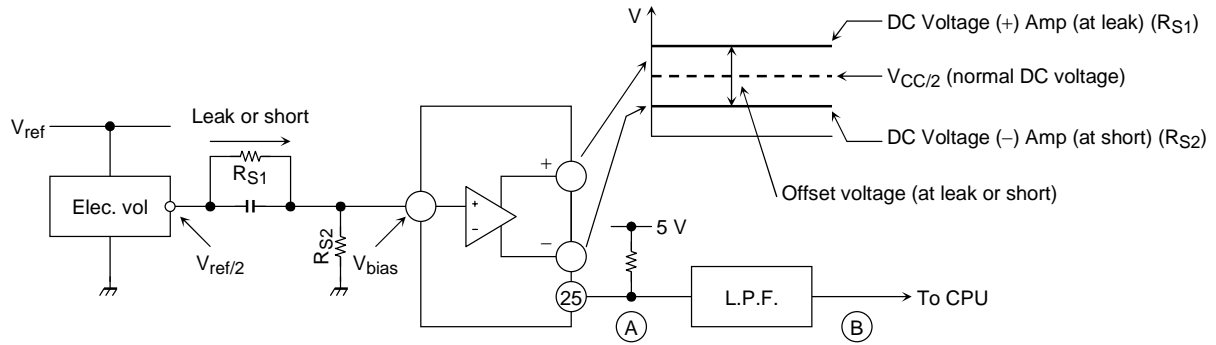

Figure 5 Mute Attenuation -  $V_{MUTE}$  (V)

**4. Off-set detection function**

In case of Appearing output offset voltage by Generating a Large Leakage Current on the input Capacitor etc.



**Figure 6 Application and Detection Mechanism**

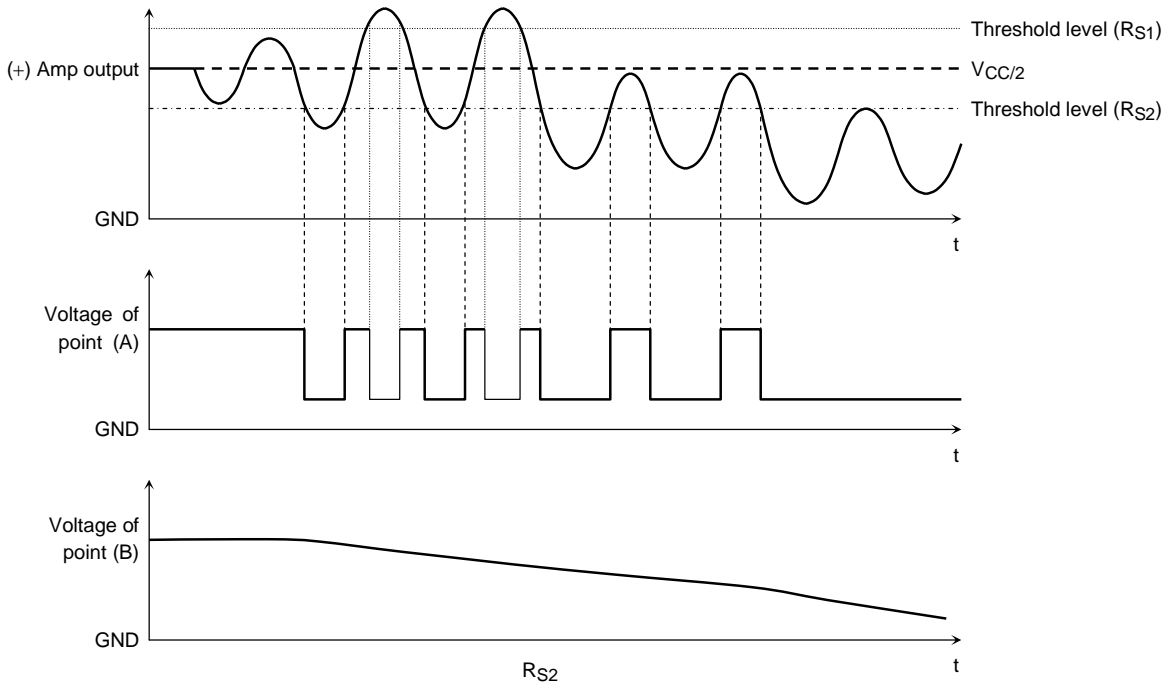

**Figure 7 Wave Form**

**5. Pop Noise Suppression**

Since the AC-GND pin (pin 16) is used as the NF pin for all amps, the ratio between the input capacitance (C1) and the AC-to-GND capacitance (C6) should be 1:4.

Also, if the power is turned OFF before the C1 and C6 batteries have been completely charged, pop noise will be generated because of the DC input unbalance.

To counteract the noise, it is recommended that a longer charging time be used for C2 as well as for C1 and C6. Note that the time which audio output takes to start will be longer, since the C2 makes the muting time (the time from when the power is turned ON to when audio output starts) is fix.

The pop noise which is generated when the muting function is turned ON/OFF will vary according to the time constant of C4.

The greater the capacitance, the lower the pop noise. Note that the time from when the mute control signal is applied to C4 to when the muting function is turned ON/OFF will be longer.

**6. External Component Constants**

Component Name	Recommended Value	Purpose	Effect		Notes
			Lower than recommended value	Higher than recommended value	
C1	0.22 $\mu$ F	To eliminate DC	Cut-off frequency is increased	Cut-off frequency is reduced	Pop noise is generated when V <sub>CC</sub> is ON
C2	10 $\mu$ F	To reduce ripple	Powering ON/OFF is faster	Powering ON/OFF takes longer	
C3	0.1 $\mu$ F	To provide sufficient oscillation margin	Reduces noise and provides sufficient oscillation margin		
C4	1 $\mu$ F	To reduce pop noise	High pop noise. Duration until muting function is turned ON/OFF is short	Low pop noise. Duration until muting function is turned ON/OFF is long	
C5	3900 $\mu$ F	Ripple filter	Power supply ripple filtering		
C6	1 $\mu$ F	NF for all outputs	Pop noise is suppressed when C1:C6 = 1:4		Pop noise is generated when V <sub>CC</sub> is ON

Note5: If recommended value is not used.

## Absolute Maximum Ratings (Ta = 25°C)

Characteristics	Symbol	Rating	Unit
Peak supply voltage (0.2 s)	V <sub>CC</sub> (surge)	50	V
DC supply voltage	V <sub>CC</sub> (DC)	25	V
Operation supply voltage	V <sub>CC</sub> (opr)	18	V
Output current (peak)	I <sub>O</sub> (peak)	9	A
Power dissipation	P <sub>D</sub> (Note 6)	125	W
Operation temperature	T <sub>opr</sub>	-40~85	°C
Storage temperature	T <sub>stg</sub>	-55~150	°C

Note 6: Package thermal resistance  $\theta_{j-T} = 1^{\circ}\text{C/W}$  (typ.) (Ta = 25°C, with infinite heat sink)

The absolute maximum ratings of a semiconductor device are a set of specified parameter values, which must not be exceeded during operation, even for an instant. If any of these rating would be exceeded during operation, the device electrical characteristics may be irreparably altered and the reliability and lifetime of the device can no longer be guaranteed. Moreover, these operations with exceeded ratings may cause break down, damage and/or degradation to any other equipment. Applications using the device should be designed such that each absolute maximum rating will never be exceeded in any operating conditions. Before using, creating and/or producing designs, refer to and comply with the precautions and conditions set forth in this documents.

## Electrical Characteristics (unless otherwise specified, V<sub>CC</sub> = 13.2 V, f = 1 kHz, R<sub>L</sub> = 4 Ω, Ta = 25°C)

Characteristics	Symbol	Test Circuit	Test Condition	Min	Typ.	Max	Unit
Quiescent current	I <sub>CCQ</sub>	—	V <sub>IN</sub> = 0	—	200	400	mA
Output power	P <sub>OUT</sub> MAX (1)	—	V <sub>CC</sub> = 14.4 V, max POWER	—	47	—	W
	P <sub>OUT</sub> MAX (2)	—	V <sub>CC</sub> = 13.7 V, max POWER	—	43	—	
	P <sub>OUT</sub> (1)	—	V <sub>CC</sub> = 14.4 V, THD = 10%	—	29	—	
	P <sub>OUT</sub> (2)	—	THD = 10%	23	25	—	
Total harmonic distortion	THD	—	P <sub>OUT</sub> = 5 W	—	0.015	0.15	%
Voltage gain	G <sub>V</sub>	—	V <sub>OUT</sub> = 0.775 V <sub>rms</sub>	24	26	28	dB
Voltage gain ratio	ΔG <sub>V</sub>	—	V <sub>OUT</sub> = 0.775 V <sub>rms</sub>	-1.0	0	1.0	dB
Output noise voltage	V <sub>NO</sub> (1)	—	R <sub>g</sub> = 0 Ω, DIN45405	—	100	—	μV <sub>rms</sub>
	V <sub>NO</sub> (2)	—	R <sub>g</sub> = 0 Ω, BW = 20 Hz~20 kHz	—	90	200	
Ripple rejection ratio	R.R.	—	f <sub>rip</sub> = 100 Hz, R <sub>g</sub> = 620 Ω V <sub>rip</sub> = 0.775 V <sub>rms</sub>	50	60	—	dB
Cross talk	C.T.	—	R <sub>g</sub> = 620 Ω V <sub>OUT</sub> = 0.775 V <sub>rms</sub>	—	70	—	dB
Output offset voltage	V <sub>OFFSET</sub>	—	—	-150	0	150	mV
Input resistance	R <sub>IN</sub>	—	—	—	90	—	kΩ
Standby current	I <sub>SB</sub>	—	Standby condition	—	2	10	μA
Standby control voltage	V <sub>SB</sub> H	—	POWER: ON	3.5	—	6.0	V
	V <sub>SB</sub> L	—	POWER: OFF	0	—	1.5	
Mute control voltage	V <sub>M</sub> H	—	MUTE: OFF	3.0	—	6.0	V
	V <sub>M</sub> L	—	MUTE: ON, R <sub>1</sub> = 47 kΩ	0	—	0.5	
Mute attenuation	ATT M	—	MUTE: ON V <sub>OUT</sub> = 7.75 V <sub>rms</sub> → Mute: OFF	80	90	—	dB

## Offset detection

Detection threshold voltage	Voff-set	—	Rpull-up = 47 kΩ, +V = 5.0V Based on output DC voltage	±1.0	±1.5	±2.0	V
-----------------------------	----------	---	---	------	------	------	---

## Test Circuit

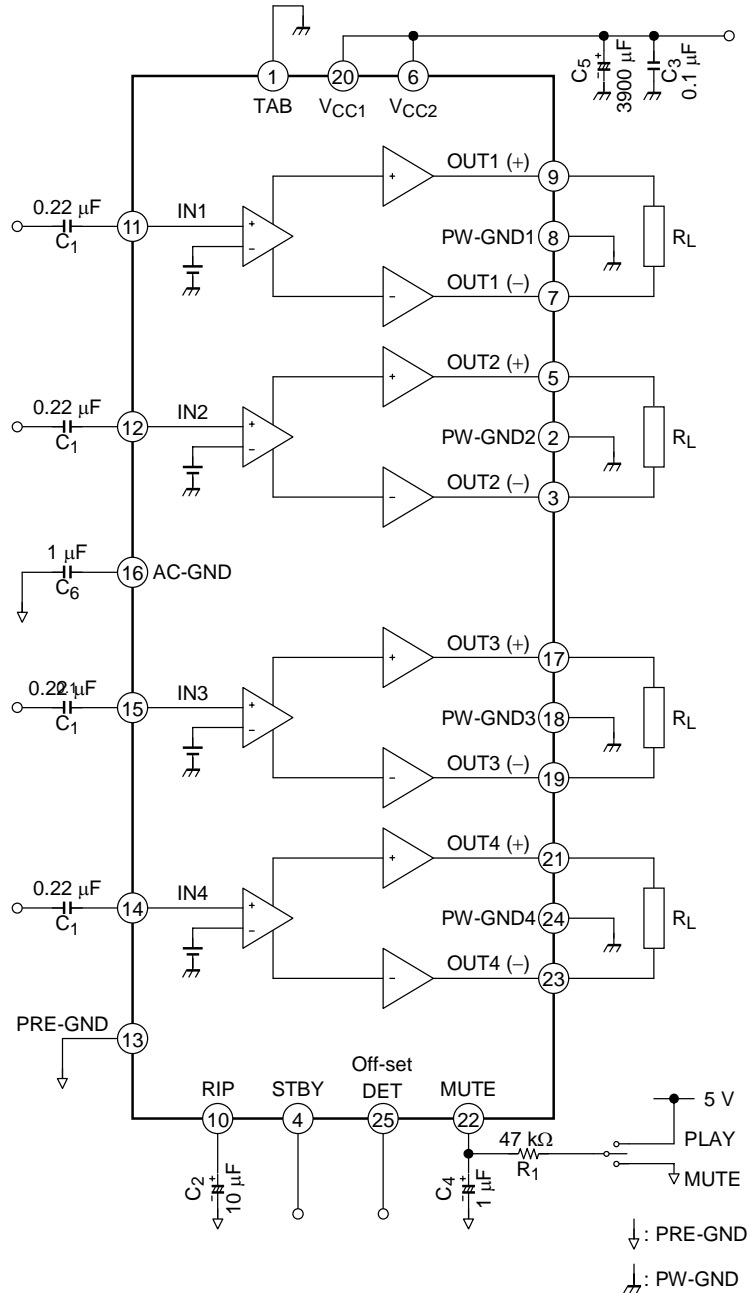

Components in the test circuits are only used to obtain and confirm the device characteristics.  
 These components and circuits do not warrant to prevent the application equipment from malfunction or failure.



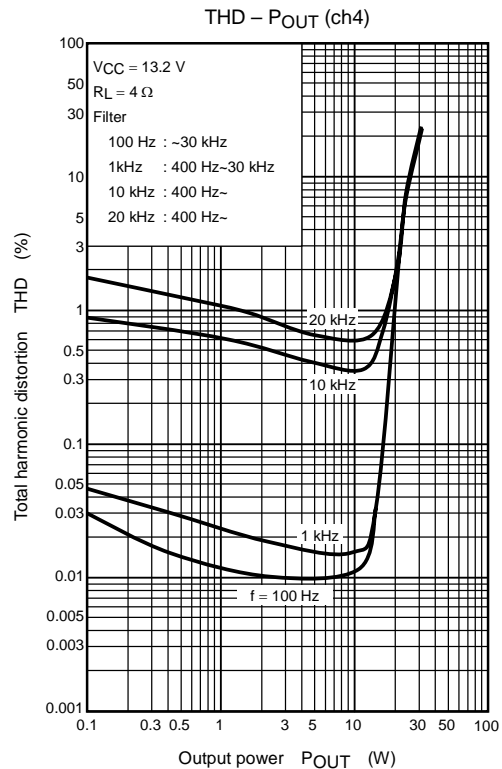
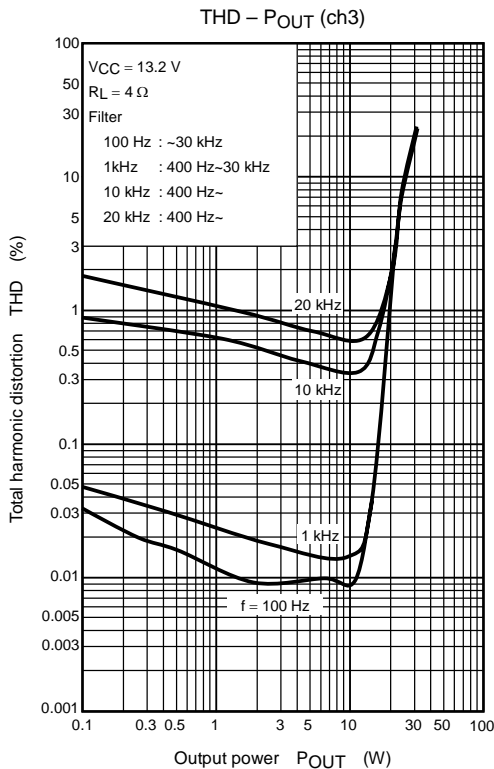
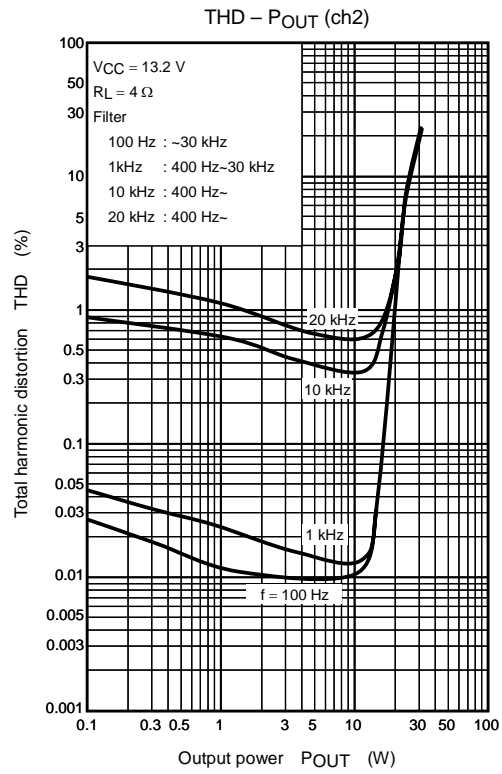
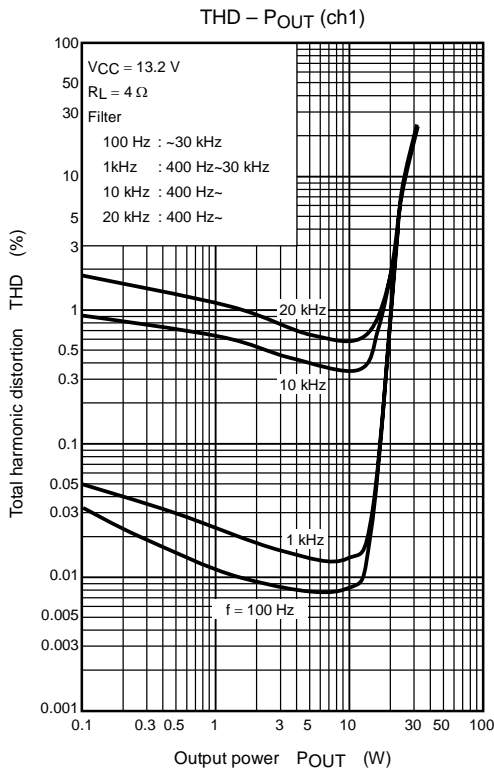

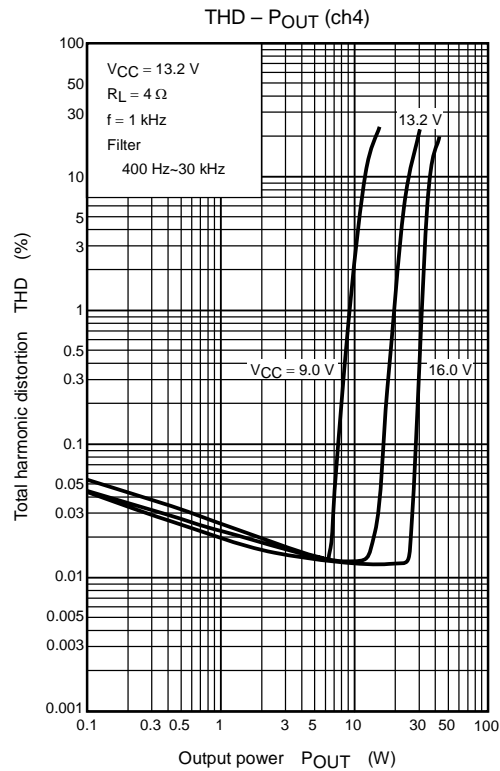
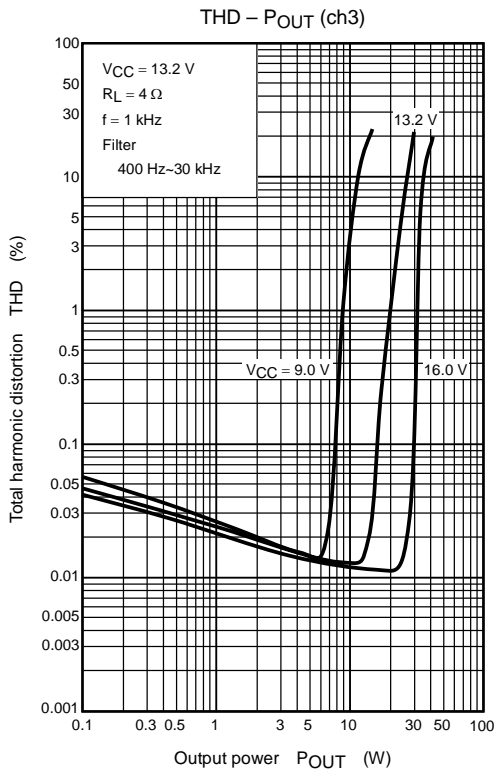
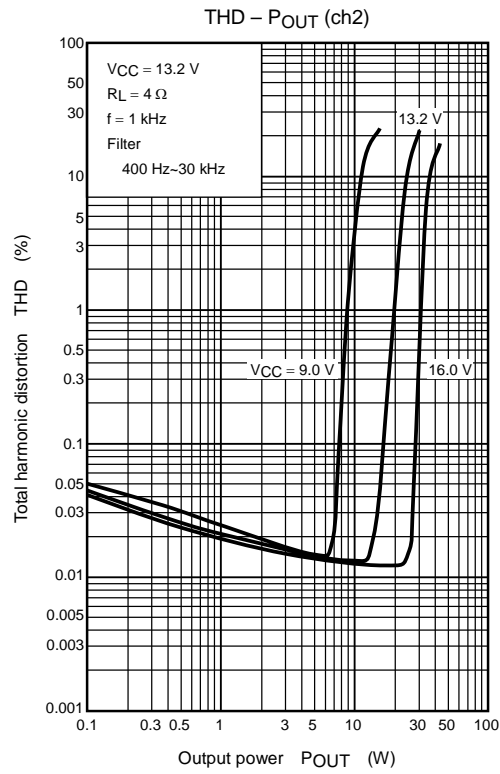
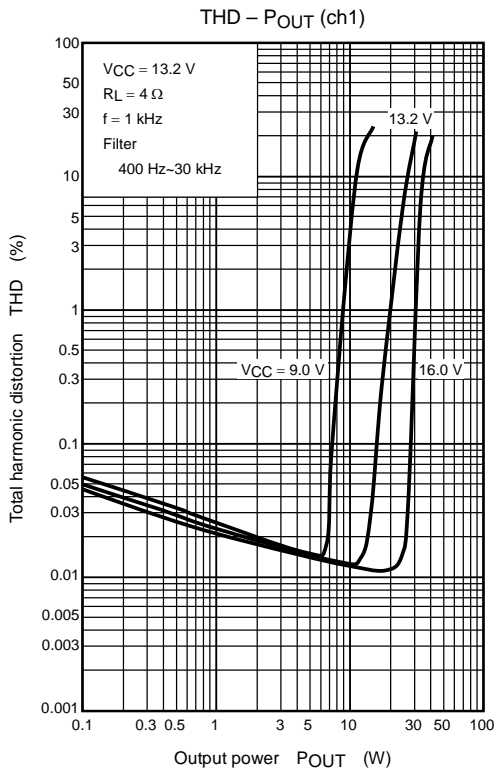

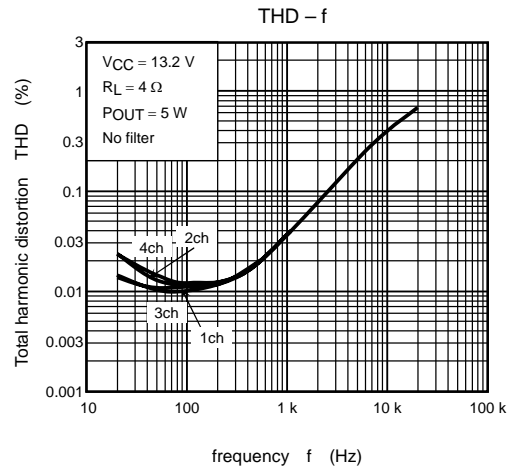
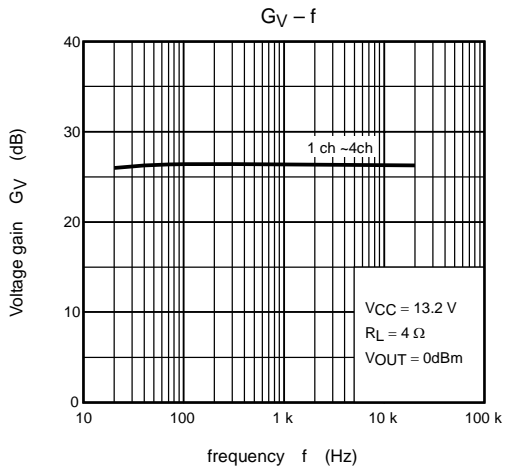
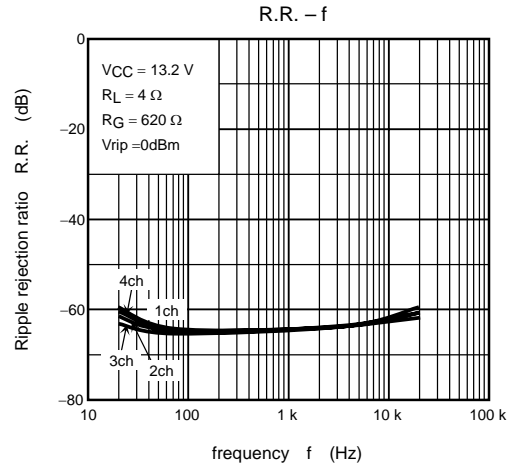
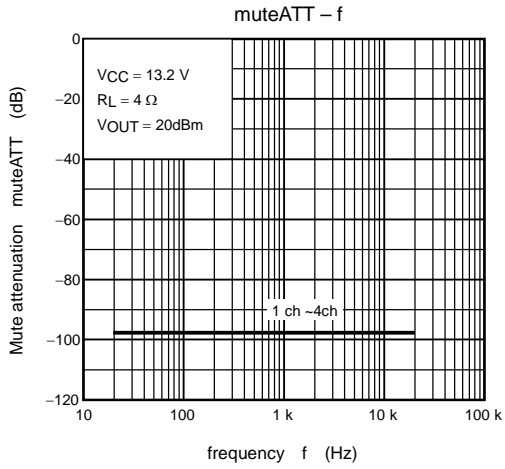

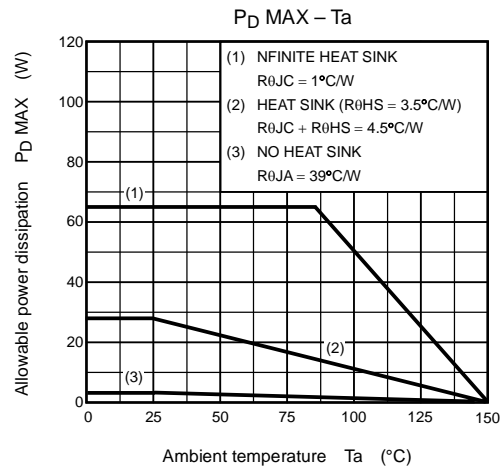
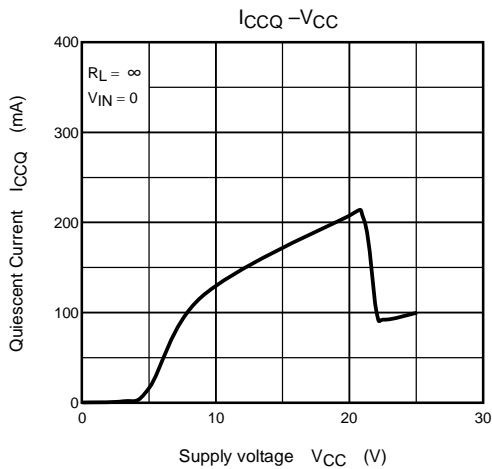
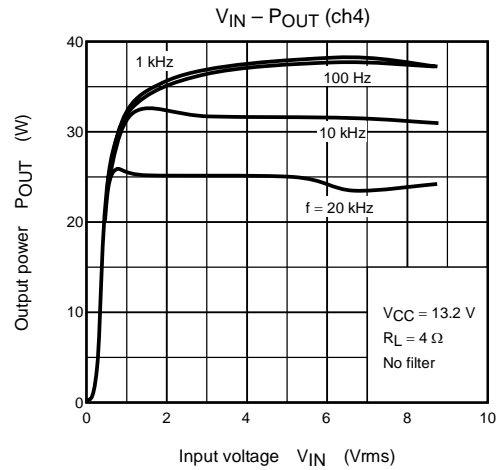
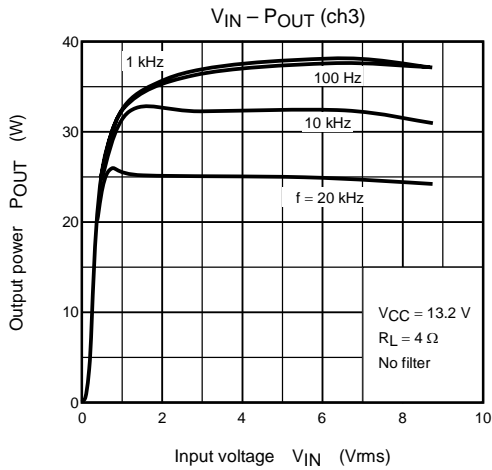
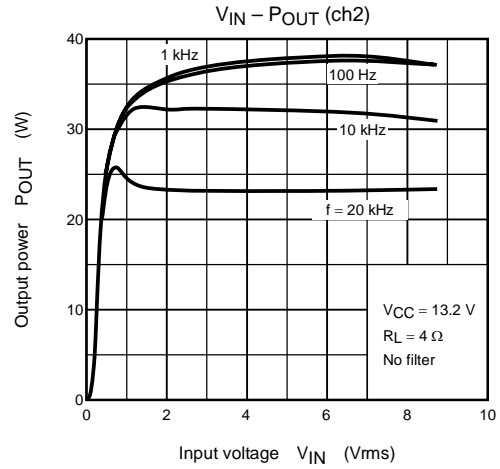
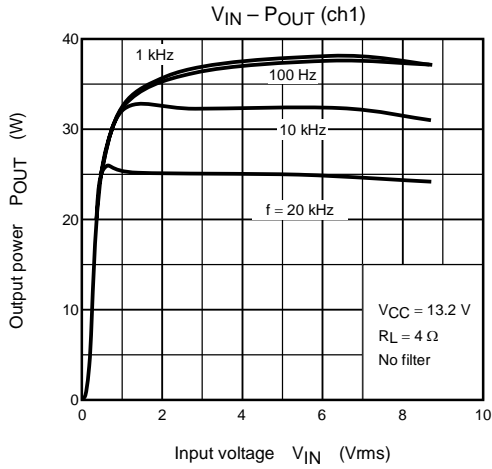

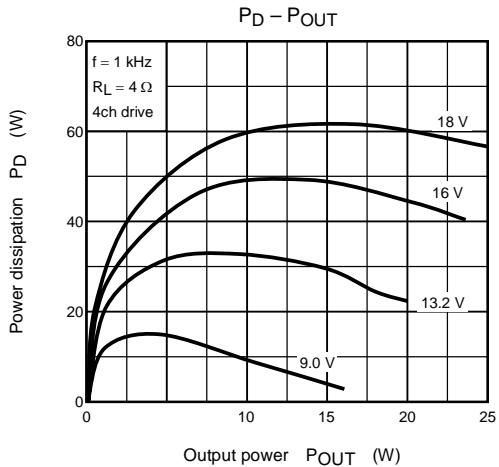
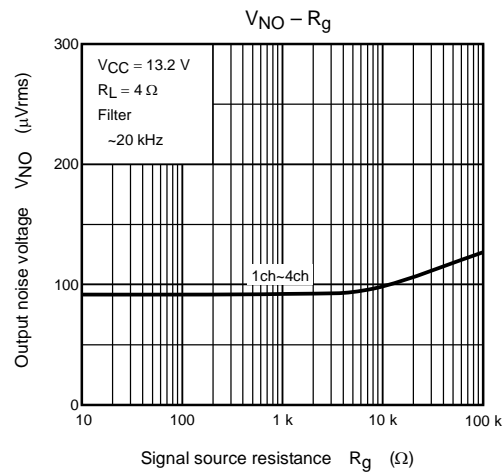
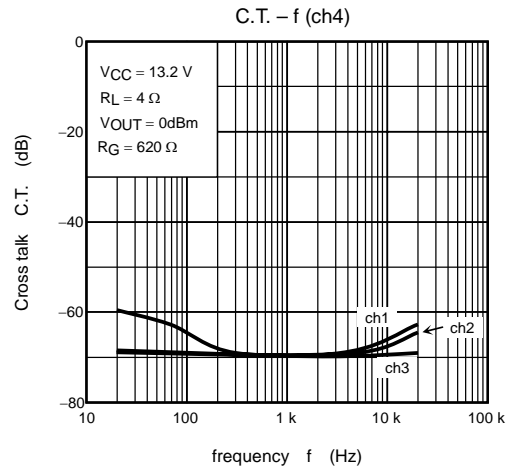
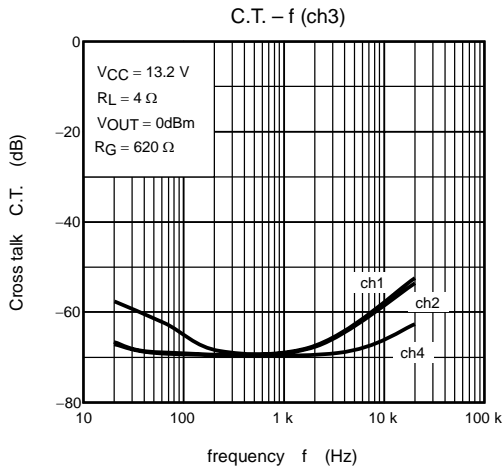
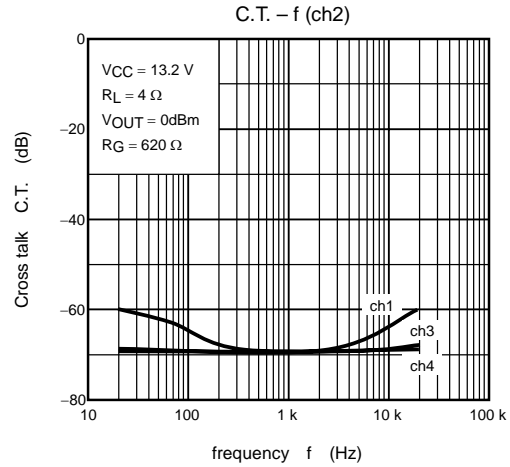
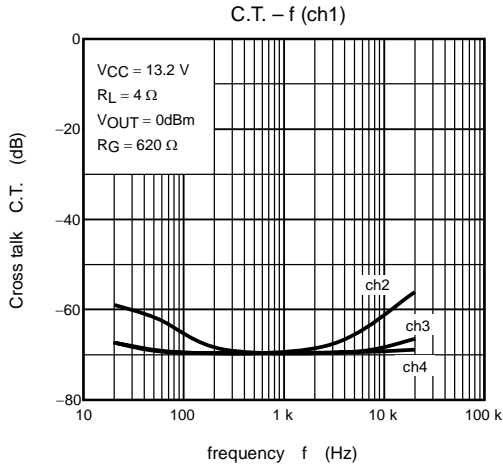

## Package Dimensions

HZIP25-P-1.00F

Unit: mm

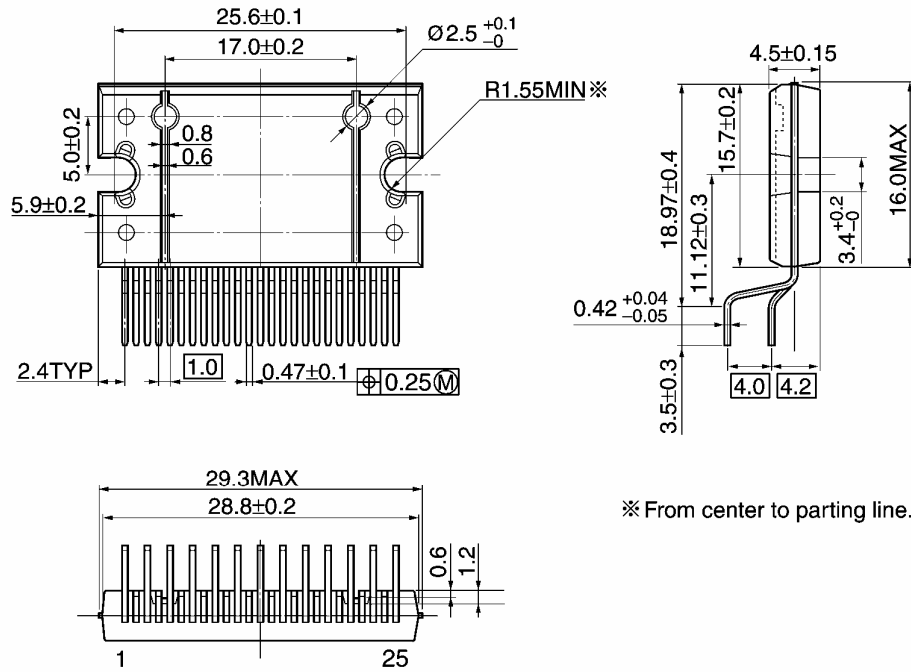

\* From center to parting line.

Weight: 7.7 g (typ.)



- Use an appropriate power supply fuse to ensure that a large current does not continuously flow in case of over current and/or IC failure. The IC will fully break down when used under conditions that exceed its absolute maximum ratings, when the wiring is routed improperly or when an abnormal pulse noise occurs from the wiring or load, causing a large current to continuously flow and the breakdown can lead smoke or ignition. To minimize the effects of the flow of a large current in case of breakdown, appropriate settings, such as fuse capacity, fusing time and insertion circuit location, are required.
- If your design includes an inductive load such as a motor coil, incorporate a protection circuit into the design to prevent device malfunction or breakdown caused by the current resulting from the inrush current at power ON or the negative current resulting from the back electromotive force at power OFF. For details on how to connect a protection circuit such as a current limiting resistor or back electromotive force adsorption diode, refer to individual IC datasheets or the IC databook. IC breakdown may cause injury, smoke or ignition.
- Use a stable power supply with ICs with built-in protection functions. If the power supply is unstable, the protection function may not operate, causing IC breakdown. IC breakdown may cause injury, smoke or ignition.
- Carefully select external components (such as inputs and negative feedback capacitors) and load components (such as speakers), for example, power amp and regulator. If there is a large amount of leakage current such as input or negative feedback condenser, the IC output DC voltage will increase. If this output voltage is connected to a speaker with low input withstand voltage, overcurrent or IC failure can cause smoke or ignition. (The over current can cause smoke or ignition from the IC itself.) In particular, please pay attention when using a Bridge Tied Load (BTL) connection type IC that inputs output DC voltage to a speaker directly.
- Over current Protection Circuit  
Over current protection circuits (referred to as current limiter circuits) do not necessarily protect ICs under all circumstances. If the Over current protection circuits operate against the over current, clear the over current status immediately. Depending on the method of use and usage conditions, such as exceeding absolute maximum ratings can cause the over current protection circuit to not operate properly or IC breakdown before operation. In addition, depending on the method of use and usage conditions, if over current continues to flow for a long time after operation, the IC may generate heat resulting in breakdown.
- Thermal Shutdown Circuit  
Thermal shutdown circuits do not necessarily protect ICs under all circumstances. If the Thermal shutdown circuits operate against the over temperature, clear the heat generation status immediately. Depending on the method of use and usage conditions, such as exceeding absolute maximum ratings can cause the thermal shutdown circuit to not operate properly or IC breakdown before operation.
- Heat Radiation Design  
When using an IC with large current flow such as power amp, regulator or driver, please design the device so that heat is appropriately radiated, not to exceed the specified junction temperature (Tj) at any time and condition. These ICs generate heat even during normal use. An inadequate IC heat radiation design can lead to decrease in IC life, deterioration of IC characteristics or IC breakdown. In addition, please design the device taking into considerate the effect of IC heat radiation with peripheral components.
- Installation to Heat Sink  
Please install the power IC to the heat sink not to apply excessive mechanical stress to the IC. Excessive mechanical stress can lead to package cracks, resulting in a reduction in reliability or breakdown of internal IC chip. In addition, depending on the IC, the use of silicon rubber may be prohibited. Check whether the use of silicon rubber is prohibited for the IC you intend to use, or not. For details of power IC heat radiation design and heat sink installation, refer to individual technical datasheets or IC databooks.



## RESTRICTIONS ON PRODUCT USE

060116EBF

- The information contained herein is subject to change without notice. 021023\_D
- TOSHIBA is continually working to improve the quality and reliability of its products. Nevertheless, semiconductor devices in general can malfunction or fail due to their inherent electrical sensitivity and vulnerability to physical stress. It is the responsibility of the buyer, when utilizing TOSHIBA products, to comply with the standards of safety in making a safe design for the entire system, and to avoid situations in which a malfunction or failure of such TOSHIBA products could cause loss of human life, bodily injury or damage to property.  
In developing your designs, please ensure that TOSHIBA products are used within specified operating ranges as set forth in the most recent TOSHIBA products specifications. Also, please keep in mind the precautions and conditions set forth in the "Handling Guide for Semiconductor Devices," or "TOSHIBA Semiconductor Reliability Handbook" etc. 021023\_A
- The TOSHIBA products listed in this document are intended for usage in general electronics applications (computer, personal equipment, office equipment, measuring equipment, industrial robotics, domestic appliances, etc.). These TOSHIBA products are neither intended nor warranted for usage in equipment that requires extraordinarily high quality and/or reliability or a malfunction or failure of which may cause loss of human life or bodily injury ("Unintended Usage"). Unintended Usage include atomic energy control instruments, airplane or spaceship instruments, transportation instruments, traffic signal instruments, combustion control instruments, medical instruments, all types of safety devices, etc. Unintended Usage of TOSHIBA products listed in this document shall be made at the customer's own risk. 021023\_B
- The products described in this document shall not be used or embedded to any downstream products of which manufacture, use and/or sale are prohibited under any applicable laws and regulations. 060106\_Q
- The information contained herein is presented only as a guide for the applications of our products. No responsibility is assumed by TOSHIBA for any infringements of patents or other rights of the third parties which may result from its use. No license is granted by implication or otherwise under any patent or patent rights of TOSHIBA or others. 021023\_C
- The products described in this document are subject to the foreign exchange and foreign trade laws. 021023\_E
- This product generates heat during normal operation. However, substandard performance or malfunction may cause the product and its peripherals to reach abnormally high temperatures.  
The product is often the final stage (the external output stage) of a circuit. Substandard performance or malfunction of the destination device to which the circuit supplies output may cause damage to the circuit or to the product. 030619\_R

About solderability, following conditions were confirmed

- Solderability
  - (1) Use of Sn-37Pb solder Bath
    - solder bath temperature = 230°C
    - dipping time = 5 seconds
    - the number of times = once
    - use of R-type flux
  - (2) Use of Sn-3.0Ag-0.5Cu solder Bath
    - solder bath temperature = 245°C
    - dipping time = 5 seconds
    - the number of times = once
    - use of R-type flux