

SERIAL E²PROM

TC89101P, TC89102P

The TC89101P is a 1024-bit serial E²PROM. The TC89102P is a 2048-bit serial E²PROM. These are fabricated with floating gate CMOS technology.

PART No.	CAPACITY	ORGANIZATION	PACKAGE
TC89101P	1024-bit	128 × 8-bit or 64 × 16-bit	DIP8
TC89102P	2048-bit	256 × 8-bit or 128 × 16-bit	

FEATURES

- ◆ Single 5 V Supply
- ◆ Low Power Dissipations
- ◆ Serial Interface
- ◆ Self timed Program cycle (Built-in Timer)
- ◆ Ready / Busy status signal
- ◆ Erase / Write Enable and Disable by software
- ◆ Erase / Write Disable for low power supply
- ◆ Program and Chip Erase
- ◆ User Selectable Organization 8-bit or 16-bit

PIN ASSIGNMENT (TOP VIEW)

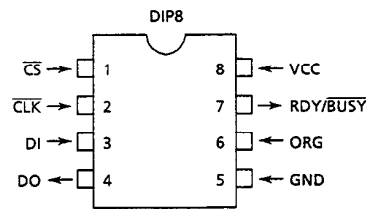

BLOCK DIAGRAM

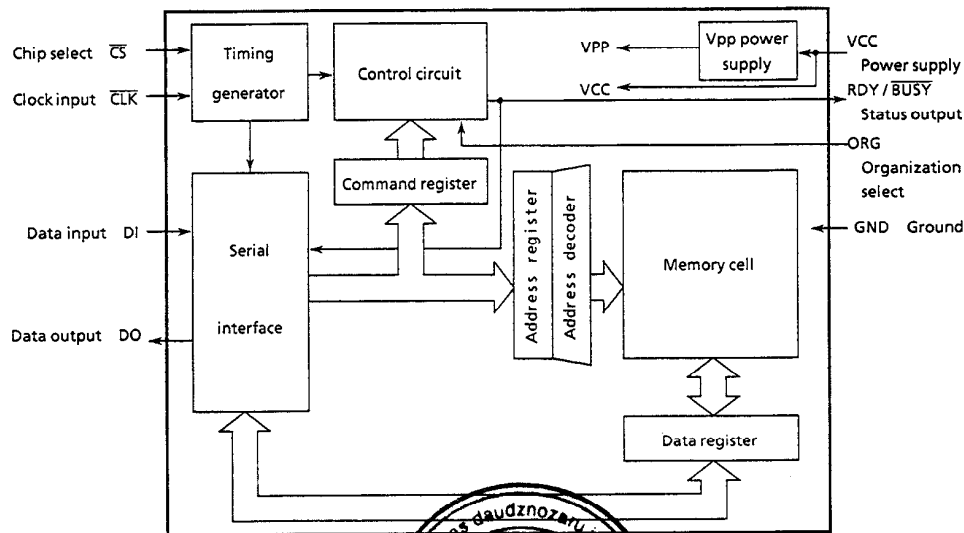

<http://www.neonet.lv/autoradio>
 E-mail: juris@mailbox.neonet.lv
 fax: +371 7184532 / 24 hours

PIN FUNCTION

PIN NAME	Input / Output	FUNCTIONS
\overline{CS}	Input	Chip select Chip is enabled when \overline{CS} is at "L" level. Set \overline{CS} to "H" level before executing instructions.
\overline{CLK}	Input	Clock input The DI data is latched at the rising edge of \overline{CLK} . The data is output from DO at the falling edge of \overline{CLK} . \overline{CLK} is enabled when \overline{CS} is at "L" level.
DI	Input	Serial data input The address, command and data input pin.
DO	Output	Serial data output The data output pin.
ORG	Input	Organization select The 16-bit organization is selected when ORG is "H" level. The 8-bit organization is selected when ORG is "L" level.
RDY / \overline{BUSY}	Output	Status output "L" level is output during program or chip erase operation. "H" level is output when program or chip erase operation is completed.
VCC	Power supply	+ 5 V
GND		0 V (GND)

OPERATIONAL DESCRIPTION

1. INSTRUCTION SET

(1) TC89101

Instruction	Address		Command	Data	
	128 x 8-bit	64 x 16-bit	C0C1 C2 C3	128 x 8-bit	64 x 16-bit
Read	A0 to A6, 0	A0 to A5, 00	1 0 0 0 0 0 0 0		
Program	A0 to A6, 0	A0 to A5, 00	0 1 1 0 0 0 0 0	D0 to D7	D0 to D15
Chip Erase	*****	*****	0 0 1 1 0 0 0 0		
Busy Monitor	*****	*****	1 0 1 1 0 0 0 0		
E/W Enable	*****	*****	1 0 0 1 0 0 0 0		
E/W Disable	*****	*****	1 1 0 1 0 0 0 0		

*: don't care

(2) TC89102

Instruction	Address		Command	Data	
	256 × 8-bit	128 × 16-bit	C0C1 C2 C3	256 × 8-bit	128 × 16-bit
Read	A0 to A7	A0 to A6, 0	1 0 0 0 0 0 0 0		
Program	A0 to A7	A0 to A6, 0	0 1 1 0 0 0 0 0	D0 to D7	D0 to D15
Chip Erase	*****	*****	0 0 1 1 0 0 0 0		
Busy Monitor	*****	*****	1 0 1 1 0 0 0 0		
E/W Enable	*****	*****	1 0 0 1 0 0 0 0		
E/W Disable	*****	*****	1 1 0 1 0 0 0 0		

*: don't care

2. OPERATION METHOD

Set \overline{CS} and \overline{CLK} to "H" level before executing instruction. \overline{CS} changes to "L" level, then \overline{CLK} is enabled and operates as the sync signal for serial I/O. The DI data is latched at the rising edge of \overline{CLK} . The data is output from DO at the falling edge of \overline{CLK} .

Execute instruction only when RDY/ \overline{BUSY} status signal is "H" level. However Busy Monitor instruction can be executed whenever.

Uses only commands which are included in the Instruction Set listed above.

(1) Read

Executing Read instruction reads out the memory data at the specified address and outputs it serially from DO.

(2) Program

Executing Program instruction automatically starts internal rewriting of the memory data at the specified address with the input data.

After Program instruction is input, \overline{CS} can be set to "H" level ever while the internal rewriting process is operating.

(3) Chip Erase

Executing Chip Erase instruction automatically Starts internal erasing of the memory data at all address.

After Chip Erase instruction is input, \overline{CS} can be set to "H" level even while the internal erasing process is operating.

(4) Busy Monitor

Executing Busy Monitor instruction outputs the RDY/ \overline{BUSY} status signal from DO.

"L" level is output during Program or Chip Erase operation. "H" level is output when Program or Chip Erase operation is completed.

The RDY/ \overline{BUSY} status signal is output until \overline{CS} is switched to "H" level.

(5) E/W Enable

Executing E/W Enable instruction sets E/W enable mode and enables Program and Chip Erase instructions.

(6) E/W Disable

Executing E/W Disable instruction sets the E/W disable mode and disables both the Program and Chip Erase instructions. Once E/W disable mode is set, E/W disable mode is held until E/W Enable instruction is executed.

3. CAUTIONS WHEN TURNING THE POWER ON AND OFF

- (1) After turning the power on, wait 1ms for warm-up before executing instruction.
- (2) After turning the power on, set either the E/W enable mode or E/W disable mode.
- (3) If the power supply voltage is lower the approximately 3.5 V, E/W Disable instruction is automatically executed internally.

4. TIMING DIAGRAMS

(1) Read

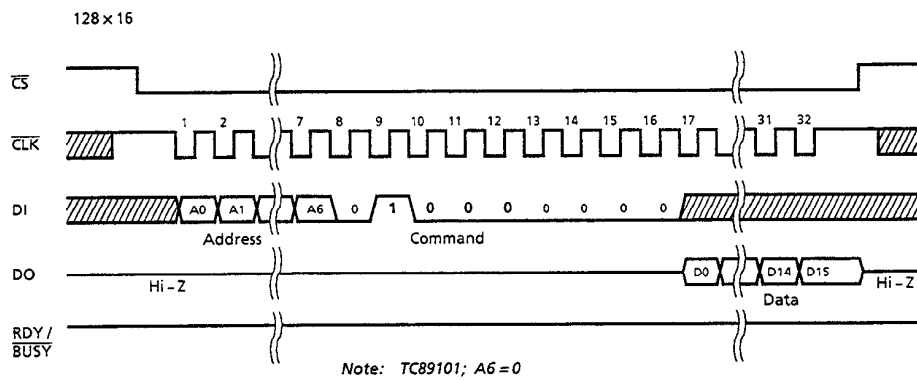
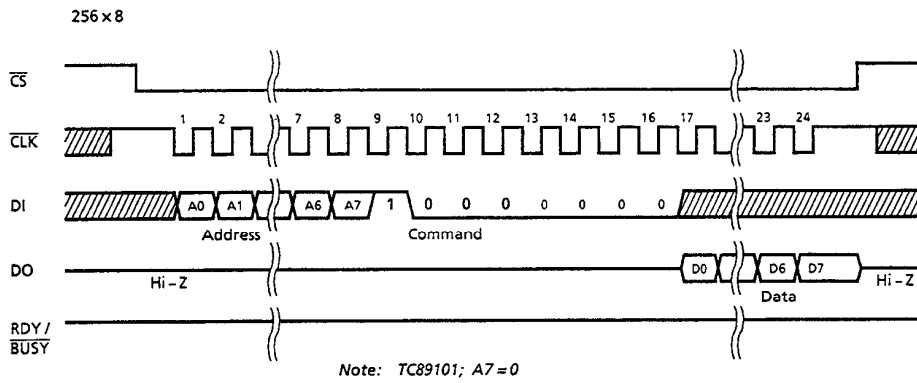

(2) Program

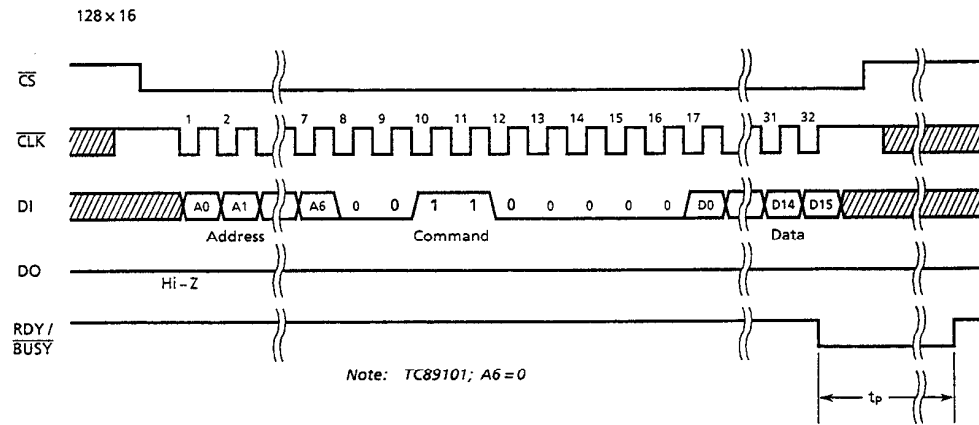
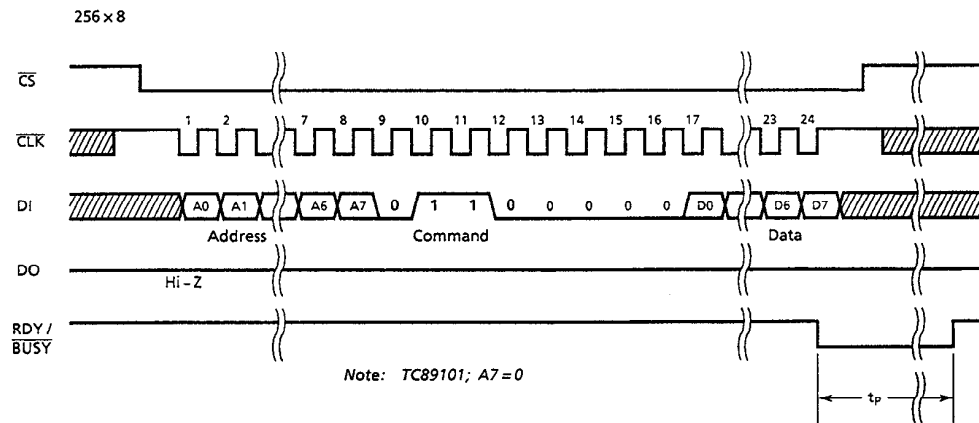

(3) Chip Erase

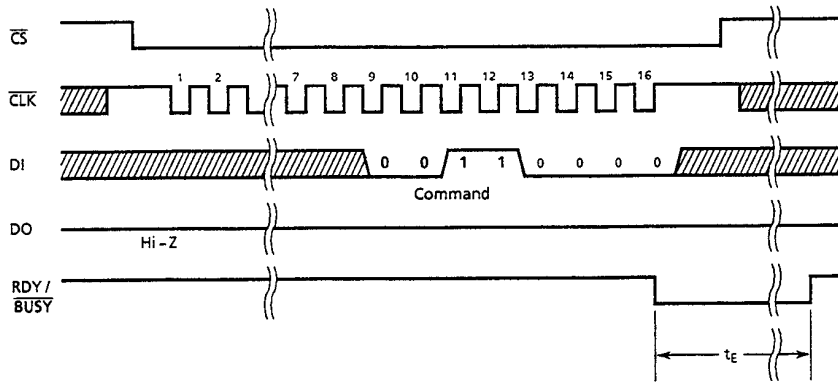

(4) Busy Monitor

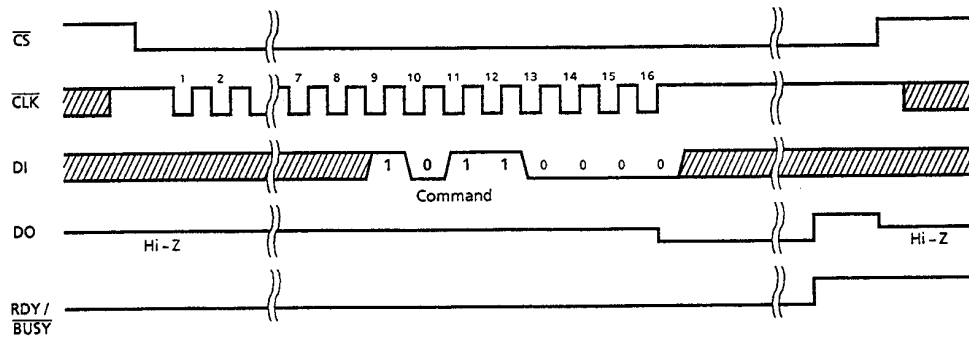

(5) E/W Enable

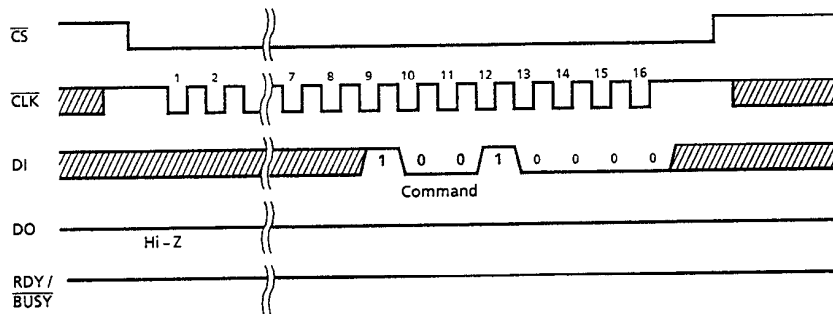

(6) E/W Disable

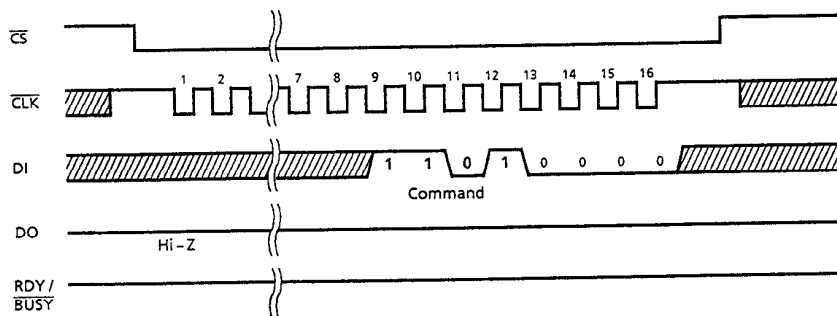

ELECTRICAL CHARACTERISTICS

ABSOLUTE MAXIMUM RATINGS (GND = 0 V)

PARAMETER	SYMBOL	RATINGS	UNITS
Supply Voltage	V_{CC}	- 0.3 to 7	V
Input Voltage	V_{IN}	- 0.3 to $V_{CC} + 0.3$	V
Output Voltage	V_{OUT}	- 0.3 to $V_{CC} + 0.3$	V
Power Dissipation	PD	600	mW
Soldering Temperature (time)	T_{sld}	260 (10 s)	°C
Storage Temperature	T_{stg}	- 55 to 125	°C
Operating Temperature	T_{opr}	0 to 70	°C

RECOMMENDED OPERATING CONDITIONS (GND = 0 V, $T_{opr} = 0$ to 70 °C)

PARAMETER	SYMBOL	PINS	CONDITIONS	Min.	Max.	UNITS
Supply Voltage	V_{CC}			4.5	5.5	V
Input Low Voltage	V_{IL}		$V_{CC} = 4.5$ V	0	0.8	V
Input High Voltage	V_{IH1}	\overline{CS} , DI, ORG	$V_{CC} = 5.5$ V	2.0	V_{CC}	V
	V_{IH2}	CLK		3.0		
Clock Frequency	f_{CLK}			0	1	MHz

D.C. CHARACTERISTICS (GND = 0 V, $T_{opr} = 0$ to 70 °C)

PARAMETER	SYMBOL	CONDITIONS	Min.	Typ.	Max.	UNITS
Input Current	I_{LI}		-	-	± 10	μA
Output Leakage Current	I_{LO}		-	-	± 10	μA
Output High Voltage	V_{OH}	$V_{CC} = 4.5$ V, $I_{OH} = -400$ μA	2.4	-	-	V
Output Low Voltage	V_{OL}	$V_{CC} = 4.5$ V, $I_{OL} = 2.1$ mA	-	-	0.4	V
Supply Current	I_{CC0}		-	-	2	mA
	I_{CCP}	During Program or Chip Erase	-	-	10	mA
	I_{CCS}	$\overline{CS} = 1$ (Except Program or Chip Erase operation)	-	-	100	μA

A.C. CHARACTERISTICS (GND = 0 V, $V_{CC} = 4.5$ to 5.5 V, $T_{opr} = 0$ to 70 °C)

PARAMETER	SYMBOL	Min.	Max.	UNITS
$\overline{\text{CLK}}$ Frequency	f_{CLK}	0	1	MHz
$\overline{\text{CLK}}$ Low Time	t_{CKL}	400	–	ns
$\overline{\text{CLK}}$ High Time	t_{CKH}	400	–	ns
$\overline{\text{CLK}}$ Input Setup Time	t_{CKS}	250	–	ns
$\overline{\text{CS}}$ Input Setup Time	t_{CSS}	250	–	ns
DO Output Delay Time (Note)	t_{ODD1}	–	250	ns
	t_{ODD2}	–	500	ns
RDY/ $\overline{\text{BUSY}}$ Output Delay Time	t_{RBD}	–	250	ns
DI Input Setup Time	t_{IDS}	250	–	ns
DI Input Hold Time	t_{IDH}	250	–	ns
Chip Erase Time	t_{E}	–	20	ms
Program Time	t_{P}	–	20	ms
Erase/Write Cycle	N_{EW}	10^4	–	cycles
Data Retention Time	t_{RET}	10	–	years

Note: $C_L = 100$ pF, $V_{OH} / V_{OL} = 2.0$ V / 0.8 V

A.C. CHARACTERISTICS TIMING DIAGRAMS

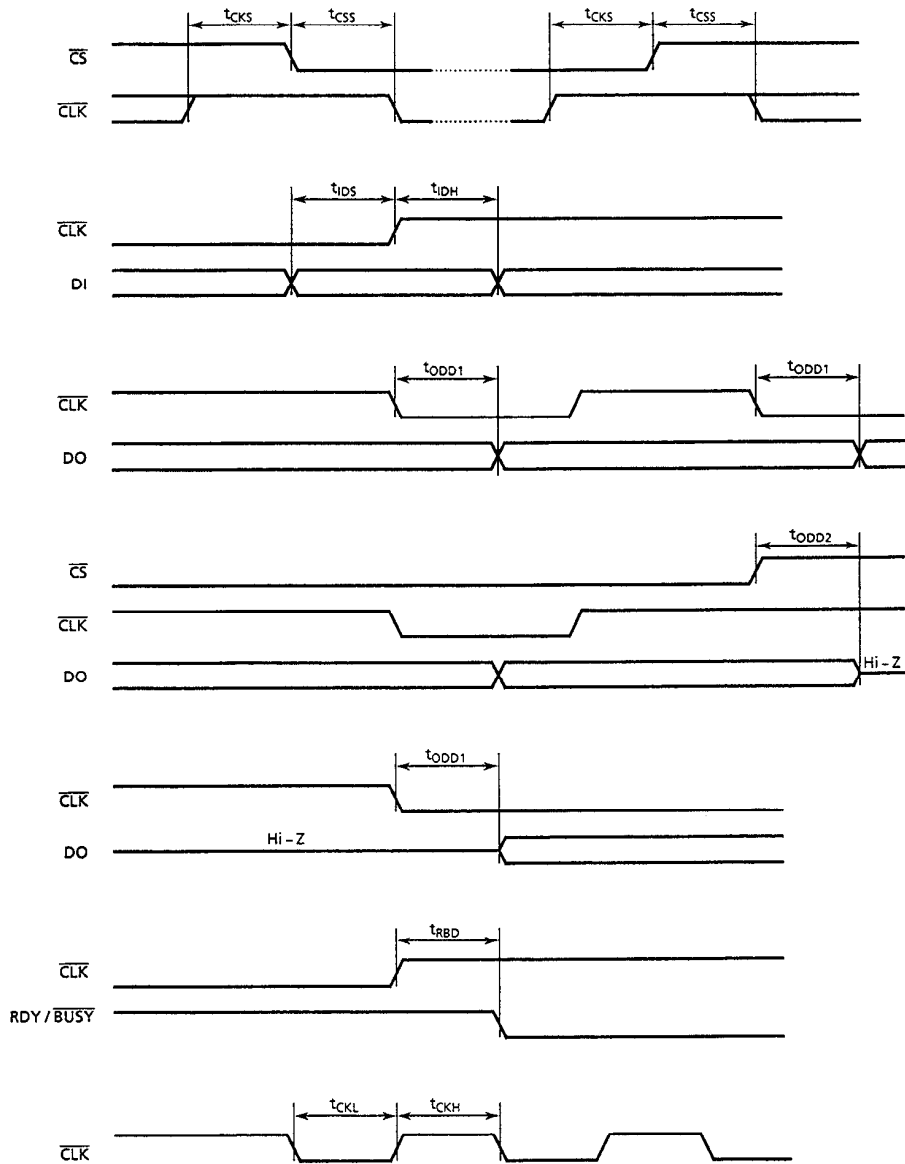

INPUT / OUTPUT CIRCUITRY

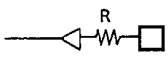
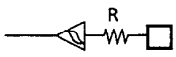
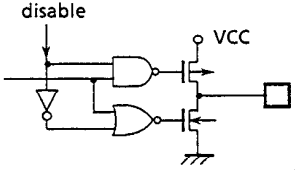
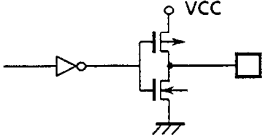
PIN NAME	I/O	CIRCUITRY	REMARKS
\overline{CS} DI ORG	Input		
\overline{CLK}	Input		Hysteresis input
DO	Output		Initial "Hi-Z"
RDY / \overline{BUSY}	Output		Initial "High"



<http://www.neonet.lv/autoradio>
 E-mail: juris@mailbox.neonet.lv
 fax: +371 7184532 / 24 hours