

# LINEAR INTEGRATED CIRCUITS

NOT FOR NEW DESIGN

## 20W Hi-Fi AUDIO AMPLIFIER

The TDA 2020 is a monolithic integrated operational amplifier in a 14-lead quad in-line plastic package, intended for use as a low frequency class B power amplifier. Typically it provides 20W output power ( $d = 1\%$ ) at  $\pm 18V/4\Omega$ ; the guaranteed output power at  $\pm 17V/4\Omega$  is 15W (DIN norm 45500). The TDA 2020 provides high output current (up to 3.5 A) and has very low harmonic and cross-over distortion. Further, the device incorporates an original (and patented) short circuit protection system, comprising an arrangement for automatically limiting the dissipated power so as to keep to working point of the output transistors within their safe operating area. A conventional thermal shut-down system is also included.

### ABSOLUTE MAXIMUM RATINGS

$V_s$	Supply voltage	$\pm 22$	V
$V_i$	Input voltage	$V_s$	V
$V_{i1}$	Differential input voltage	$\pm 15$	V
$I_o$	Output peak current (internally limited)	3.5	A
$P_{tot}$	Power dissipation at $T_{case} \leq 75^\circ C$	25	W
$T_{stg}, T_j$	Storage and junction temperature	-40 to 150	$^\circ C$

ORDERING NUMBERS: TDA 2020 A82 dual in-line plastic package  
 TDA 2020 A92 quad in-line plastic package  
 TDA 2020 AC2 dual in-line plastic package with spacer  
 TDA 2020 AD2 quad in-line plastic package with spacer

### MECHANICAL DATA

Dimensions in mm

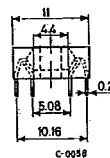
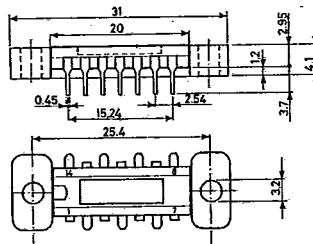
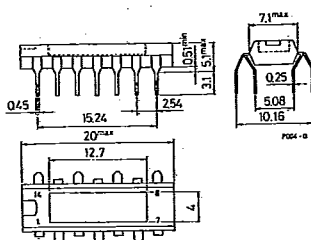



**CONNECTION AND SCHEMATIC DIAGRAMS**  
(top view)

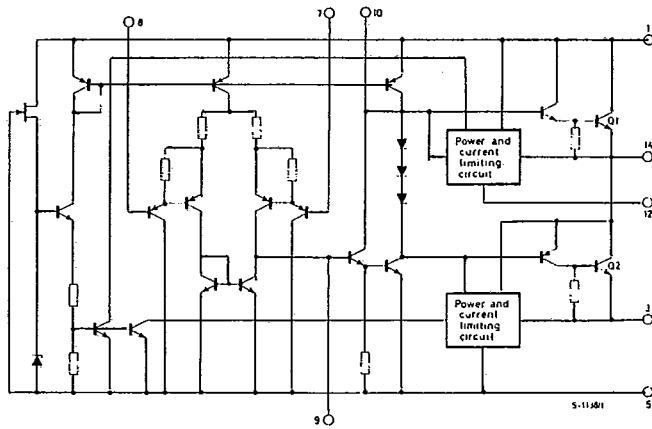
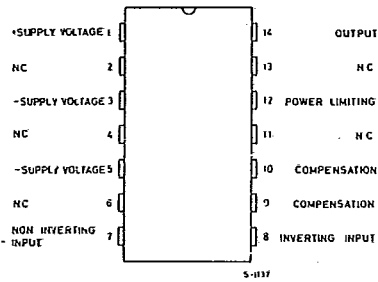

The copper slug is electrically connected to pin 5 (substrate)

**TEST CIRCUIT**

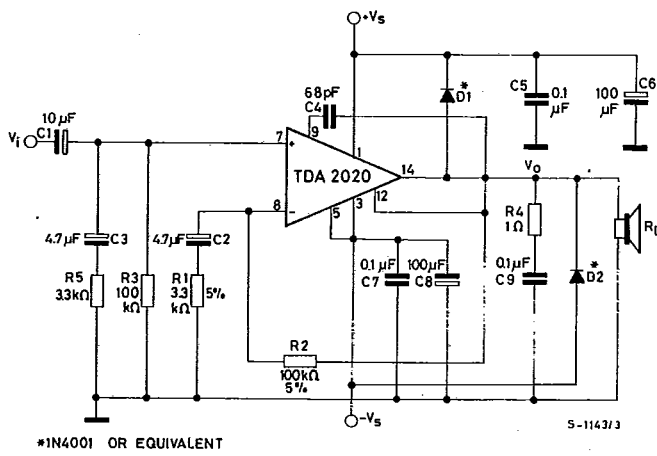

**THERMAL DATA**

$R_{th J-case}$	Thermal resistance junction-case	max	3	$^{\circ}C/W$
1272	G-07	560		



**ELECTRICAL CHARACTERISTICS**

(Refer to the test circuit,  $V_s = \pm 17V$ ,  $T_{amb} = 25^\circ C$  unless otherwise specified)

Parameter	Test conditions	Min.	Typ.	Max.	Unit	
$V_s$	Supply voltage	$\pm 5$		$\pm 22$	V	
$I_d$	Quiescent drain current	$V_s = \pm 22 V$	60		mA	
$I_b$	Input bias current		0.15		$\mu A$	
$V_{os}$	Input offset voltage		5		mV	
$I_{os}$	Input offset current		0.05		$\mu A$	
$V_{os}$	Output offset voltage		10	100	mV	
$P_o$	Output power	$d = 1\%$ $G_v = 30 \text{ dB}$ $T_{case} \leq 70^\circ C$ $f = 40 \text{ to } 15\,000 \text{ Hz}$ $V_s = \pm 17V$ $R_L = 4 \Omega$ $V_s = \pm 18V$ $R_L = 4 \Omega$ $V_s = \pm 18V$ $R_L = 8 \Omega$	15	18.5 20 16.5		W W W
		$d = 10\%$ $G_v = 30 \text{ dB}$ $T_{case} \leq 70^\circ C$ $f = 1 \text{ kHz}$ $V_s = \pm 17V$ $R_L = 4 \Omega$ $V_s = \pm 18V$ $R_L = 8 \Omega$		24 20		W W
$V_i$	Input sensitivity	$G_v = 30 \text{ dB}$ $f = 1 \text{ kHz}$ $P_o = 15 \text{ W}$ $V_s = \pm 17V$ $R_L = 4 \Omega$ $V_s = \pm 18V$ $R_L = 8 \Omega$		260 380		mV mV
B	Frequency response (-3 dB)	$R_L = 4 \Omega$ $C_4 = 68 \text{ pF}$	10 to 160 000		Hz	
d	Distortion	$P_o = 150 \text{ mW to } 15W$ $R_L = 4 \Omega$ $G_v = 30 \text{ dB}$ $T_{case} \leq 70^\circ C$ $f = 1 \text{ kHz}$ $f = 40 \text{ to } 15\,000 \text{ Hz}$		0.2 0.3	1	% %
		$P_o = 150 \text{ mW to } 15W$ $V_s = \pm 18V$ $R_L = 8 \Omega$ $G_v = 30 \text{ dB}$ $T_{case} \leq 70^\circ C$ $f = 1 \text{ kHz}$ $f = 40 \text{ to } 15\,000 \text{ Hz}$		0.1 0.25		% %
$R_i$	Input resistance (pin 7)		5		$M\Omega$	
$G_v$	Voltage gain (open loop)		100		dB	
$G_v$	Voltage gain (closed loop)	$R_L = 4 \Omega$ $f = 1 \text{ kHz}$	29.5	30	30.5	dB



ELECTRICAL CHARACTERISTICS (continued)

Parameter	Test conditions	Min.	Typ.	Max.	Unit
$e_N$	Input noise voltage		4		$\mu V$
$i_N$	Input noise current		0.1		nA
SVR	Supply voltage rejection		50		dB
$I_d$	Drain current		1		A
			0.7		A
$T_{sd}$	Thermal shut-down junction temperature		140		$^{\circ}C$
$T_{sd}$	Thermal shut-down case temperature		105		$^{\circ}C$

Fig. 1 - Output power vs. supply voltage

Fig. 2 - Output power vs. supply voltage

Fig. 3 - Distortion vs. output power

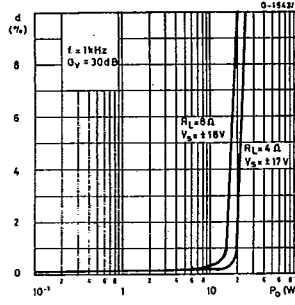
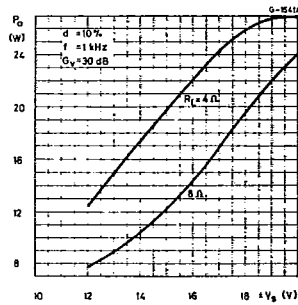
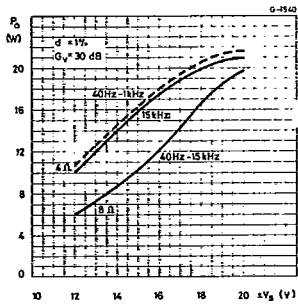



Fig. 4 - Distortion vs. output power ( $R_L = 4 \Omega$ )

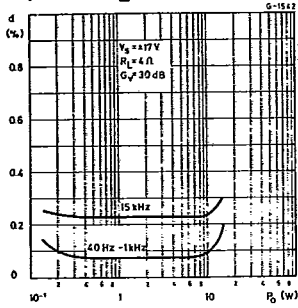

Fig. 5 - Distortion vs. output power ( $R_L = 8 \Omega$ )

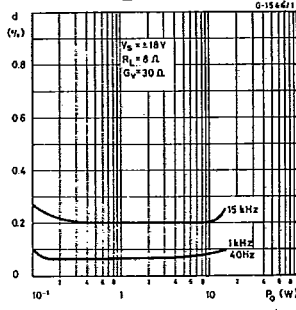

Fig. 6 - Distortion vs. frequency

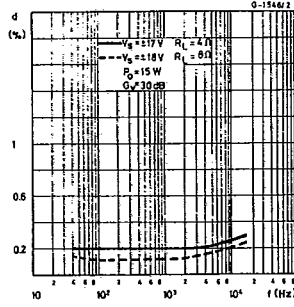

Fig. 7 - Output power vs. frequency

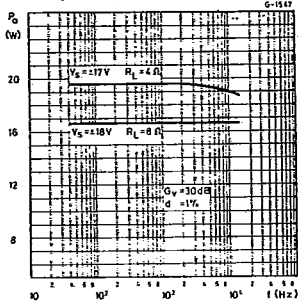

Fig. 8 - Sensitivity vs. output power ( $R_L = 4 \Omega$ )

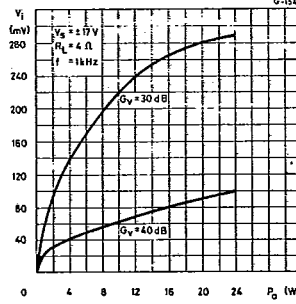

Fig. 9 - Sensitivity vs. output power ( $R_L = 8 \Omega$ )

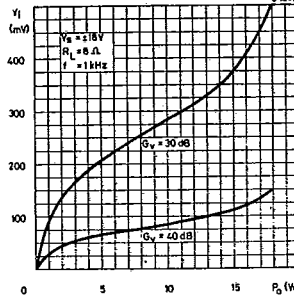

Fig. 10 - Open loop frequency response with different values of the rolloff capacitor C4

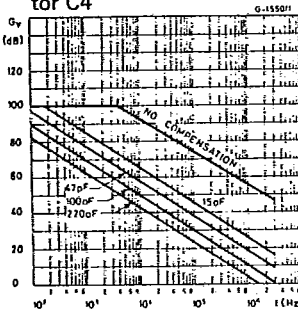

Fig. 11 - Value of C4 vs. voltage gain for different bandwidths

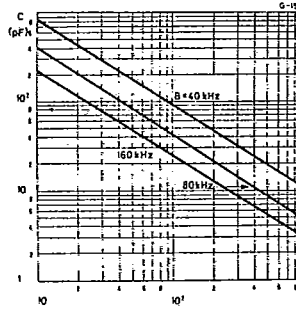
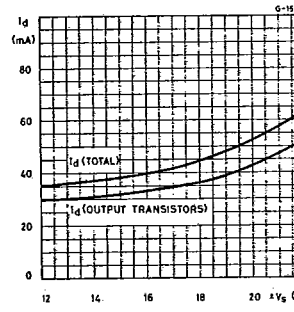

Fig. 12 - Quiescent current vs. supply voltage





T-74-05-01

Fig. 13 - Supply voltage rejection vs. voltage gain

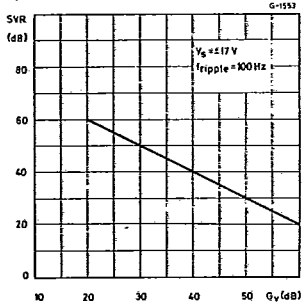

Fig. 14 - Power dissipation and efficiency vs. output power

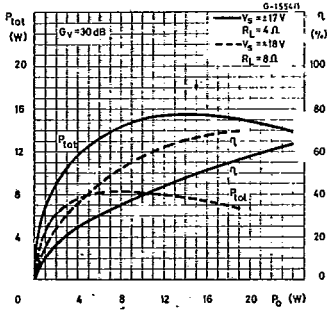
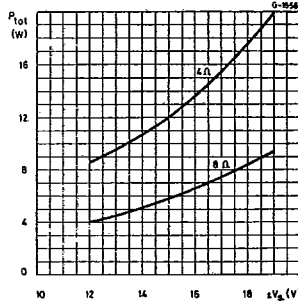
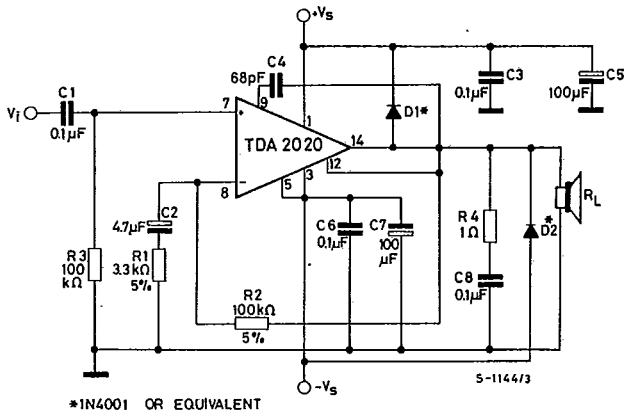

Fig. 15 - Maximum power dissipation vs. supply voltage (sine wave operation)



APPLICATION INFORMATION

Fig. 16 - Application circuit with split power supply



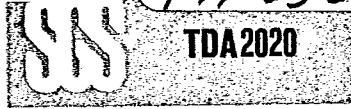

Fig. 17 - P.C. Board and component layout for the circuit of fig. 16 (1:1 scale)

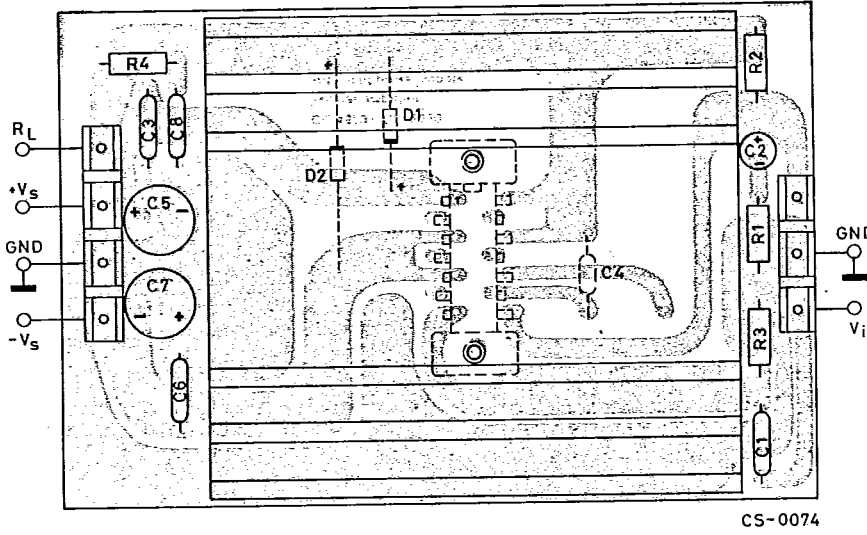

Fig. 18 - 30W bridge amplifier configuration with split power supply ( $R_L = 8 \Omega$  ;  $V_s = \pm 17V$ )

