



General Description

The TP6317 is a VFD (Vacuum Fluorescent Display) controller/driver that is driven on a 1/4 to 1/11-duty factor. It consists of 11 segment output lines, 6 grid output lines, 5 segment/grid output drivelines, a display memory, a control circuit, stand-by control, and a key scan circuit. Serial data is input to TP6317 through a three-line serial interface. This VFD controller/driver is ideal as a peripheral device for front panel control of green DVD/VCD feature.

Features

- Multiple display modes (11-segment & 11-digit to 16-segment & 4-digit)
- Key scanning (6 × 4 matrices)
- Dimming circuit (eight steps)
- High-voltage output ($V_{DD} - 35V$ max)
- LED ports (3 chs, 20 mA max)
- General-purpose input port (1 bits)
- No external resistor necessary for driver outputs (P-ch open-drain + pull-down resistor output)
- Remote control code coding support NEC format
- Stand-by control
- Serial interface (CLK, STB, D_{IN} , D_{OUT})

Ordering Information

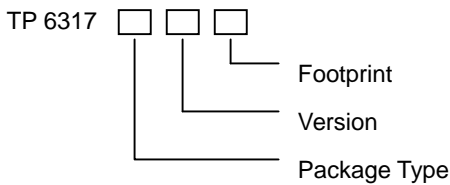

Package Type	F: LQFP
Footprint	S: 2.0 mm L: 3.2 mm

Block Diagram

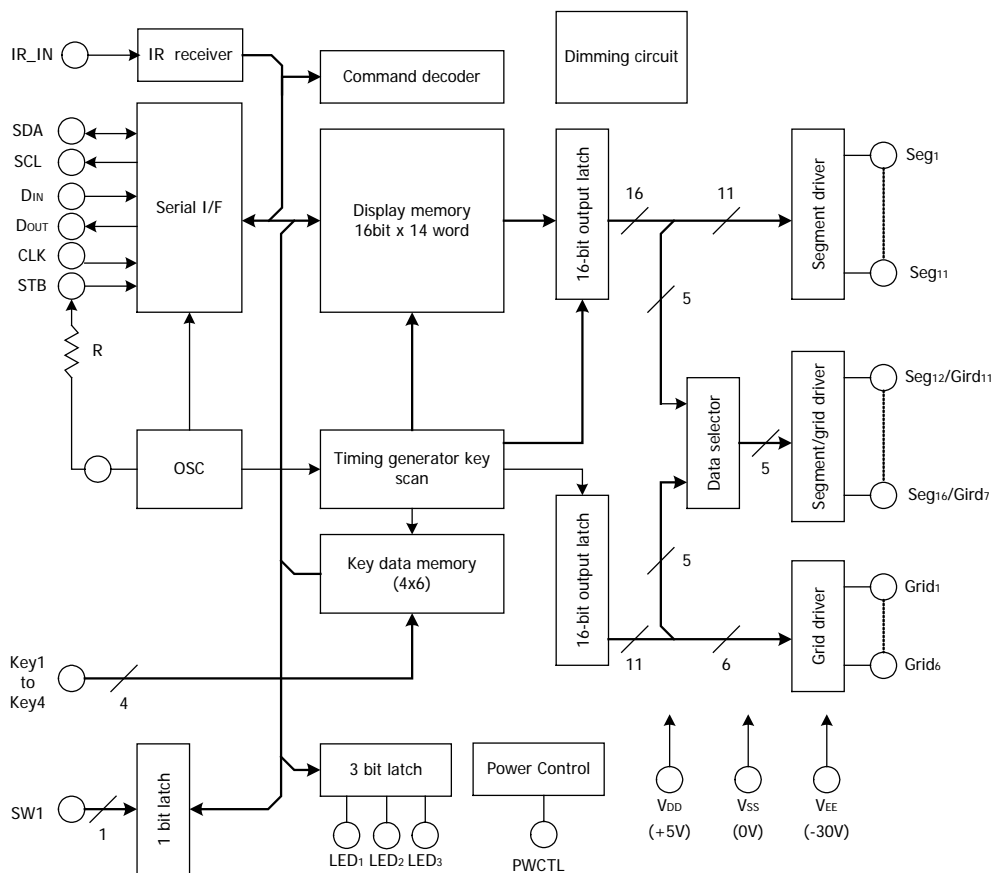



Pin Configuration

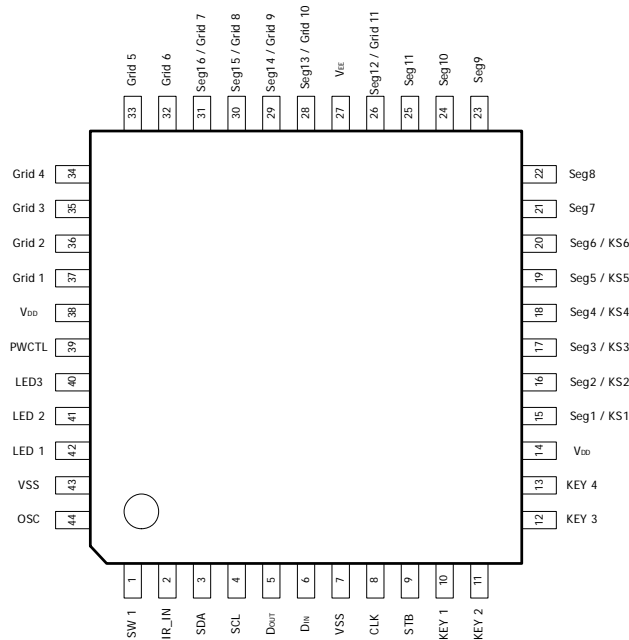

Pin Description

Pin No.	Symbol	Pin Name	Description
6	D _{IN}	Date input	Input serial data at rising edge of shift clock, starting from the lower bit.
5	D _{OUT}	Date output	Outputs serial data at falling edge of shift clock, starting from the lower bit. This is N-ch open-drain output pin.
9	STB	Strobe	Initializes the serial interface at rising or falling edge to make TP6317 waiting for reception of command. Data input after STB falls is processed as command. While command data is processed, current processing is stopped, and serial interface is initialized. While STB is high, CLK is ignored.
8	CLK	Clock input	Reads serial data at rising edge, and outputs data at falling edge.
44	OSC	Oscillator pin	Connect a resistor to this pin to determine the oscillation frequency to this pin.
15 to 20	Seg ₁ /KS ₁ to Seg ₆ /KS ₆	High-voltage output	Segment output pins (Dual function as key source).
21 to 25	Seg ₇ to Seg ₁₁	High-voltage output (Segment)	Segment output pins.
37 to 32	Grid ₁ to Grid ₆	High-voltage output (Grid)	Grid output pins.
26, 28 to 31	Seg ₁₁ /Grid ₁₁ to Seg ₁₆ /Grid ₇	High-voltage output (Segment/grid)	These pins are selectable for segment or grid driving.
42 to 40	LED ₁ to LED ₃	LED output	CMOS output. +20 mA max.
10 to 13	KEY ₁ to KEY ₄	Key data input	Data input to these pins is latched at the end of display cycle.
1	SW ₁	Switch input	This pin is 1-bit general-purpose input port.
2	IR-IN	IR input	Optic receiver input.
3	SDA	Data	Serial data line.
4	SCL	Clock	Serial clock line.
14, 38	V _{DD}	Logic power	5V ± 10%
7, 43	V _{SS}	Logic ground	Connect this pin to system GND.
27	V _{EE}	Pull-down level	V _{DD} - 35 V max.
39	PWCTL	Power control	Power on control



Functional Description

Display RAM and Power control RAM Address

The display RAM stores the data transmitted from an external device to TP6317 through the serial interface, and is assigned addresses as follows, in units of 8 bits:

Seg ₁	Seg ₄	Seg ₈	Seg ₁₂	Seg ₁₆
00H _L	00H _U	01H _L	01H _U	DIG1
02H _L	02H _U	03H _L	03H _U	DIG2
04H _L	04H _U	05H _L	05H _U	DIG3
06H _L	06H _U	07H _L	07H _U	DIG4
08H _L	08H _U	09H _L	09H _U	DIG5
0AH _L	0AH _U	0BH _L	0BH _U	DIG6
0CH _L	0CH _U	0DH _L	0DH _U	DIG7
0EH _L	0EH _U	0FH _L	0FH _U	DIG8
10H _L	10H _U	11H _L	11H _U	DIG9
12H _L	12H _U	13H _L	13H _U	DIG10
14H _L	14H _U	15H _L	15H _U	DIG11
16H _L A0~A3	16H _U A4~A7	17H _L A8~A11	17H _U A12~A15	Pwctl Custom Address
18H _L D0~D3 SET1 _L	18H _U D4~D7 SET1 _U	19H _L D0~D3 SET2 _L	19H _U D4~D7 SET2 _U	Remote Code Set1~Set2
1AH _L D0~D3 SET3 _L	1AH _U D4~D7 SET3 _U	1BH _L D0~D3 SET4 _L	1BH _U D4~D7 SET4 _U	Remote Code Set3~Set4
1CH _L D0~D3 SET5 _L	1CH _U D4~D7 SET5 _U	1DH _L D0~D3 SET6 _L	1DH _U D4~D7 SET6 _U	Remote Code Set5~Set6
1EH _L D0~D3 SET7 _L	1EH _U D4~D7 SET7 _U	1FH _L D0~D3 SET8 _L	1FH _U D4~D7 SET8 _U	Remote Code Set7~Set8
20H _L Key1~Key4	20H _U Key5~Key8	21H _L Key9~Key12	21H _U Key13~Key16	Key Code
22H _L Key17~Key20	22H _U Key21~Key24			Key Code

Notes:

- Unused remote code must be filled with FFH (Ex.: SET8 unused FFH → 1FH).
- Key code must be set "1" for wakeup mode and clear with "0" to unable this function. Key1 is a special key. Non-masking can always have the wakeup function, so recommend using the power key.
(Ex.: If you want Key2 be set with wakeup mode, then bit 1 of 20H must be set "1";
on the other side, if you want key2 be set without wakeup mode, then bit1 of 20H must clear with "0".)

b ₀	b ₃ b ₄	b ₇
XX H _L	XX H _U	
Lower 4 bits	Higher 4 bits.	

Key Matrix and Key-Input Data Storage RAM

The key matrix is of 6 × 4 configuration, as shown below.

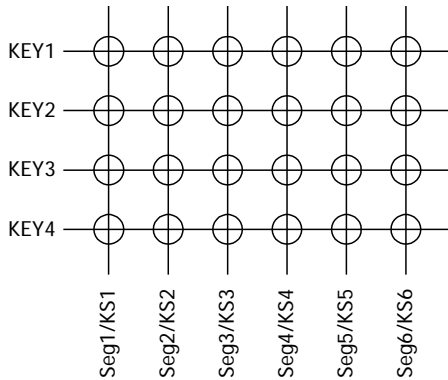

The data of each key is stored as illustrated below, and is read by a read command, starting from the least significant bit.

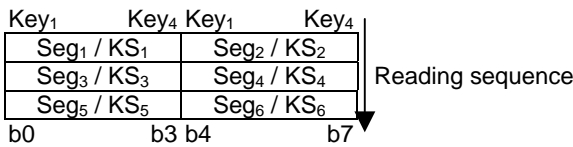

LED PORT & Power OFF

Data is written to the LED port by a write command, starting from the least significant bit of the port. When a bit of this port is 0, the corresponding LED lights; when the bit is 1, the LED goes off. The data of bits 3 through 7 is ignored. When the power is off, the bit is 0; the PWCTL pin goes low (Power Off).

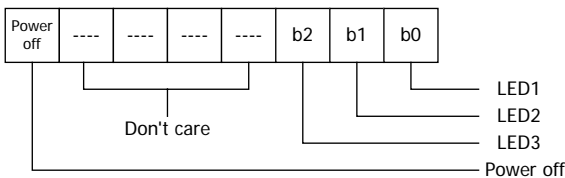

On power application, all LEDs and power off are "1".

SW, Power on Code and key Data

The SW, power on code and key data are read by a read command, starting from the least significant bit. Bits 5 through 8 of the SW data are 0; Bits 2 through 4 of the SW data are skipped (Please refer to application notes in this document).

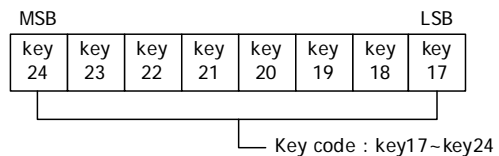
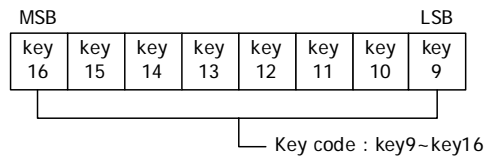
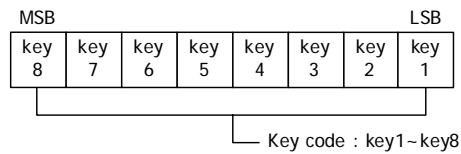
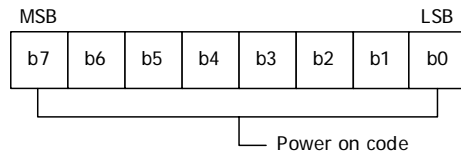
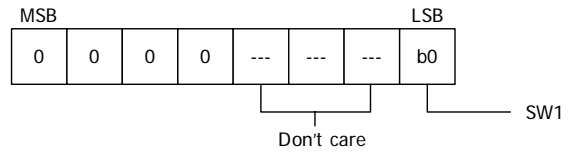

Commands

A command sets the display mode and status of the VFD driver.

The first 1 byte input to TP6317 through the D_{IN} pin after the STB pin falls is regarded as a command.

If STB is high while a command/data is transmitted, serial communication is initialized, and the transmitting command/data is invalid; however, the command/data already transmitted remains valid.



(1) Display mode setting command

This command initializes TP6317 and selects the number of segments and number of grids (1/4 to 1/11-duty, 11 segments to 16 segments).

On power application, the 11-digit, 11-segment mode is selected.

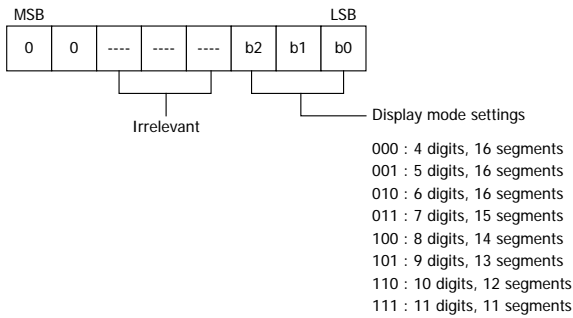

(4) Display control command

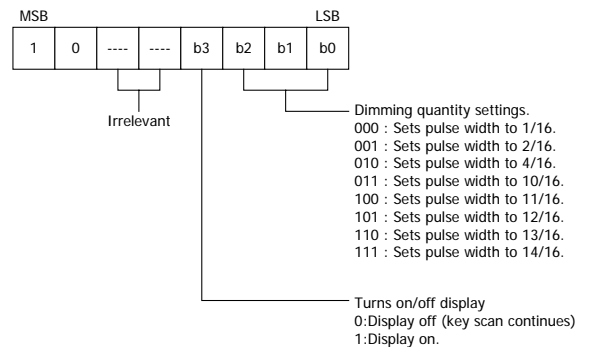

On power application, the 14/16-pulse width is set and the display is turned off.

(2) Data setting commands

This command sets data write and read modes.

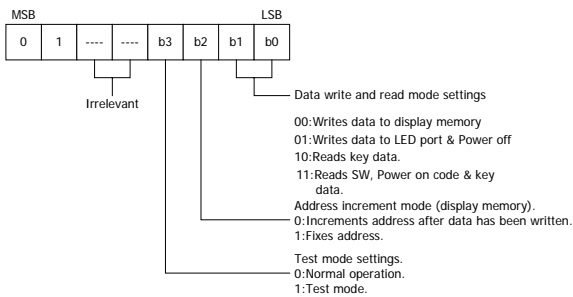

On power application, the normal operation mode and address increment mode set.

(3) Address setting command

This command sets an address of the display memory or power control data memory.

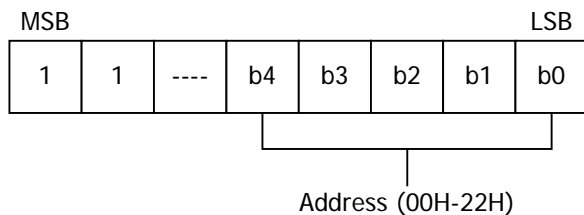

If address 23H or higher is set, the data is ignored; unit a correct address is set.

On power application, the address is set to 00H.

Key Scanning and Display Timing

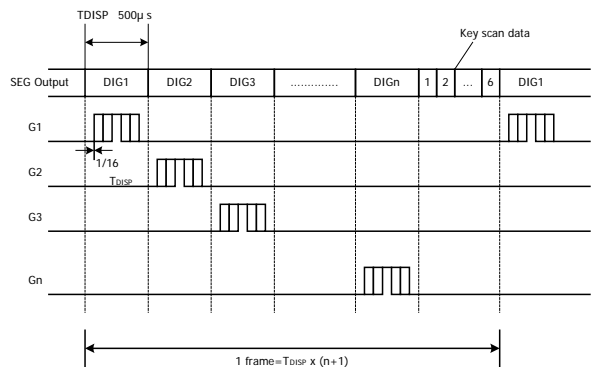

One cycle of key scanning consists of two frames, and data of 6 × 4 matrices is stored in RAM.

Serial Communication Format

Reception (command/data write)

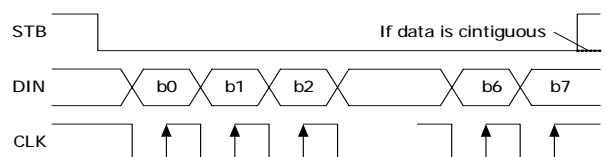



Transmission (data read)

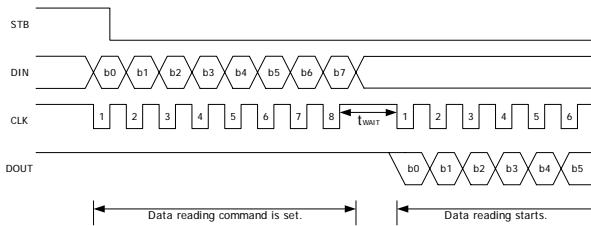

Because the D_{OUT} pin is an N-ch open-drain output pin, be sure to connect an external pull-up resistor to this pin (1kΩ to 10 kΩ).

*: When data is read, a wait time (t_{WAIT}) of 1μs is necessary from the rising of the eighth clock that has set the command till the falling of the first clock that has read the data.

Absolute Maximum Ratings (Ta = 25°C, Vss = 0V)

Parameter	Symbol	Ratings	Unit
Logic Supply Voltage	V _{DD}	-0.5 to + 7.0	V
Driver Supply Voltage	V _{EE}	V _{DD} +0.5 to V _{DD} -40	V
Logic Input Voltage	V _{I1}	-0.5 to V _{DD} +0.5	V
VFD Driver Output Voltage	V _{o2}	V _{EE} -0.5 to V _{DD} +0.5	V
LED Driver Output Current	I _{o1}	+25	mA
VFD Driver Output Current	I _{o2}	-40 (grid) -15 (segment)	mA
Power Dissipation	P _D	800*	mW
Operating Ambient Temperature	T _{opt}	0 to +70	
Storage Temperature	T _{stg}	-65 to +150	

* Derate at -6.4 mW/ at Ta = 25 or higher.

Recommended Operating Conditions (Ta = -20°C to +70°C, Vss = 0V)

Parameter	Symbol	Min.	Typ.	Max.	Unit	Test Condition
Logic Supply Voltage	V _{DD}	4.5	5	5.5	V	
High-Level input Voltage	V _{IH}	0.7V _{DD}		V _{DD}	V	
Low-Level input Voltage	V _{IL}	0		0.3V _{DD}	V	
Driver Supply Voltage	V _{EE}	0		V _{DD} -35	V	

Maximum power consumption P_{MAX} = VFD driver dissipation + R_L dissipation + LED driver dissipation + dynamic power consumption.

Where segment current = 3 mA, grid current = 15mA, and LED current = 20 mA,

VFD driver dissipation = number of segments x 6 + number of grids/(number of grids + 1) x 30 (mW)

R_L dissipation (V_{DD}-V_{EE})²/50 x (segment+1) (mW)

LED driver dissipation = number of LEDs x 20(mW)

Dynamic power consumption = V_{DD} x 5(mW)



DC Electrical Characteristics

($T_a = -20^{\circ}\text{C}$ to $+70^{\circ}\text{C}$, $V_{DD} = 4.5\text{V}$ to 5.5V , $V_S = 0\text{V}$, $V_{EE} = V_{DD} - 35\text{V}$)

Parameter	Symbol	Min.	Typ.	Max.	Unit	Test Conditions
High-Level Output Voltage	V_{OH1}	$0.9 V_{DD}$			V	LED ₁ – LED ₄ , $I_{OH1} = -1\text{ mA}$
Low-Level Output Voltage	V_{OL1}			1	V	LED ₁ – LED ₄ , $I_{OL1} = 20\text{ mA}$
Low-Level Output Voltage	V_{OL2}			0.4	V	D _{OUT} , $I_{OL2} = 4\text{ mA}$
High-Level Output Current	I_{OH21}	-3			mA	$V_O = V_{DD} - 2\text{V}$, Seg ₁ to Seg ₁₁
High-Level Output Current	I_{OH22}	-15			mA	$V_O = V_{DD} - 2\text{V}$, Grid ₁ to Grid ₆ , Seg ₁₂ /Seg ₁₁ to Seg ₁₆ /Seg ₇
Driver Leakage Current	I_{OLEAK}			-10	μA	$V_O = V_{DD} - 35\text{V}$, Drive off
Output Pull-Down Resistor	R_L	50	100	150	$k\Omega$	Drive output
Input Current	I_i			± 1	μA	$V_i = V_{DD}$ or V_{SS}
High-Level Input Voltage	V_{IH}	$0.6 V_{DD}$			V	
Low-Level Input Voltage	V_{IL}			$0.3 V_{DD}$	V	
Hysteresis Voltage	V_H		0.35		V	CLK, D _{IN} , STB
Dynamic Current Consumption	I_{DDdyn}			5	mA	Under no load, display off

AC (Switching) Electrical Characteristics

($T_a = -20^{\circ}\text{C}$ to $+70^{\circ}\text{C}$, $V_{DD} = 4.5\text{V}$ to 5.5V , $V_{EE} = -30\text{V}$)

Parameter	Symbol	Min.	Typ.	Max.	Unit	Test Conditions
Oscillation Frequency	f_{OSC}	350	500	650	kHz	$R = 33k\Omega$
Propagation Delay Time	t_{PLZ}			300	ns	CLK \Rightarrow DOUT
	t_{PZL}			100	ns	CL = 15pF, $R_L = 10k\Omega$
Rise Time	t_{TZH1}			2	μs	CL = 300 PF Seg1 to Seg11 Grid1 to Grid6 Seg12/Grid11 to Seg16/Grid7
	t_{TZH2}			0.5	μs	
Fall Time	t_{THZ}			120	μs	CL = 300 pF, Segn, Gridn
Maximum Clock Frequency	f_{max}	1			MHz	Duty = 50%
Input Capacitance	C1			15	pF	

Timing Conditions ($T_a = -20^{\circ}\text{C}$ to $+70^{\circ}\text{C}$, $V_{DD} = 4.5\text{V}$ to 5.5V)

Parameter	Symbol	Min.	Typ.	Max.	Unit	Test Conditions
Clock Pulse Width	PWCLK	400			ns	
Strobe Pulse Width	PWSTB	1			μs	
Data Setup Time	t_{SETUP}	100			ns	
Data Hold Time	t_{HOLD}	100			ns	
Clock-Strobe Time	$t_{CLK-STB}$	1			μs	CLK STB
Wait Time	t_{WAIT}	1			μs	CLK CLK



Switching Characteristic Waveform

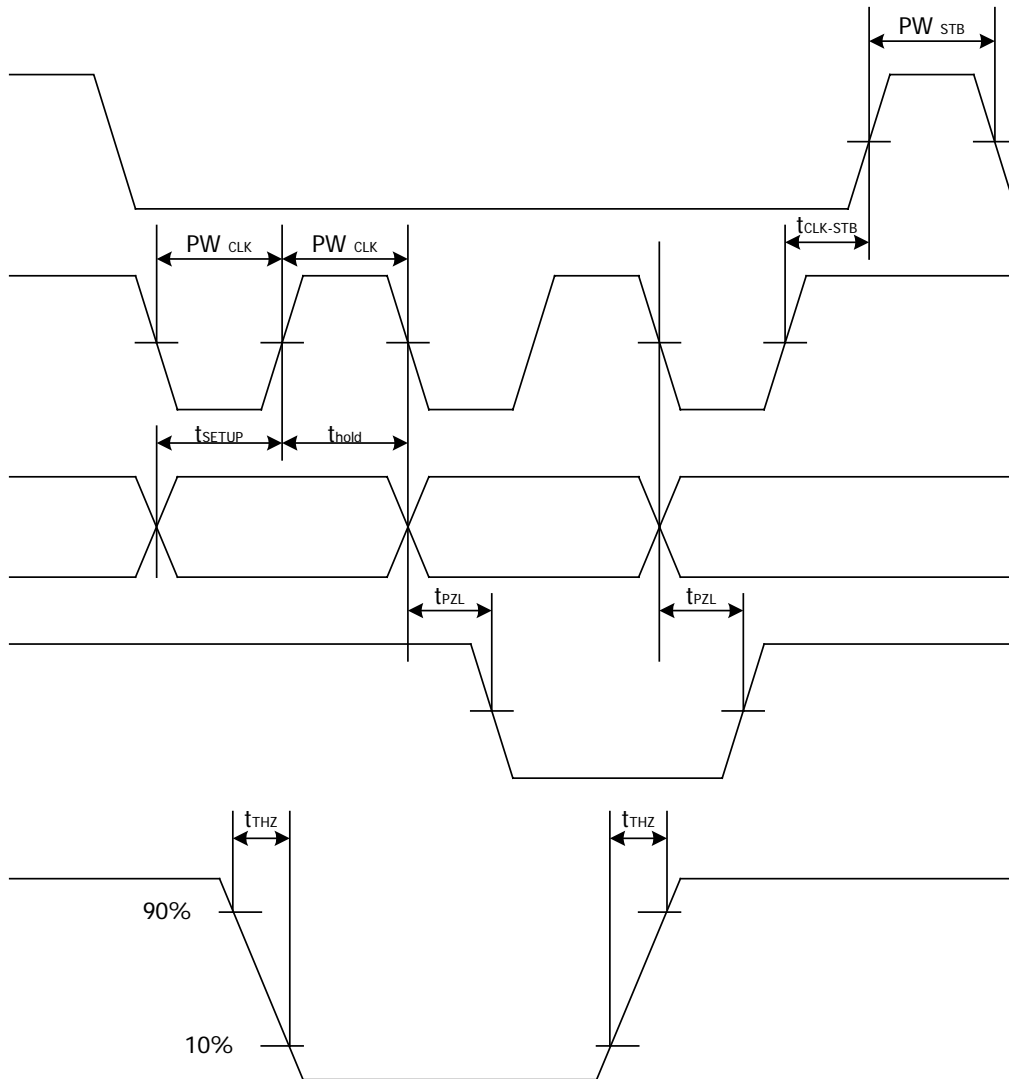



Application

- For green DVD or VCD

Updating Display Memory By Incrementing Address

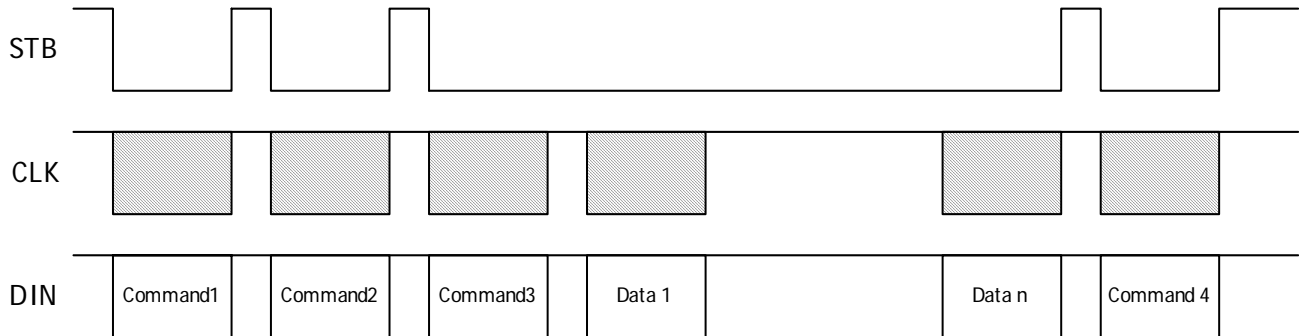

- Command1: sets display mode
- Command2: sets data
- Command3: sets address
- Data 1 to n: transfers display data (22 bytes max.)
- Command4: controls display

Updating Specific Address

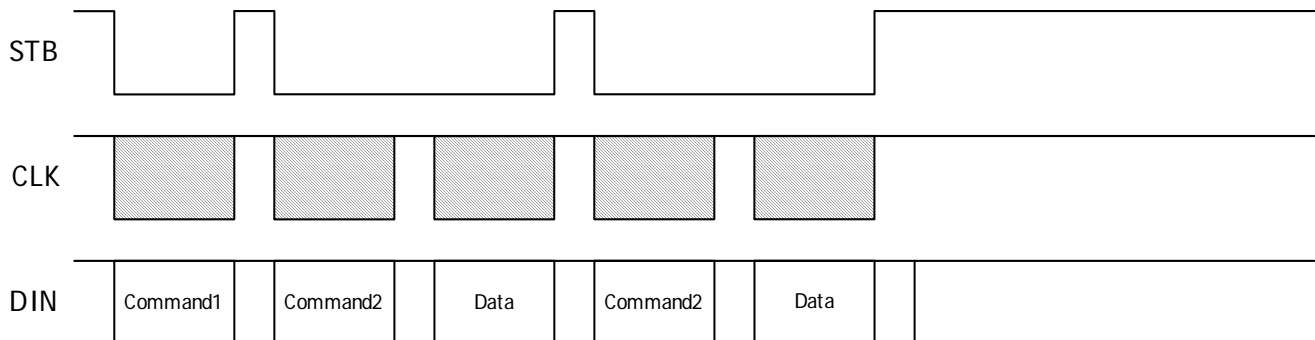

- Command1: sets data
- Command2: sets address
- Data: display data



Package Information

44-Pin Plastic LQFP Long-Lead (Footprint = 3.2mm)

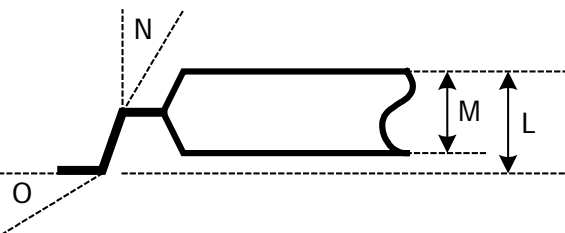
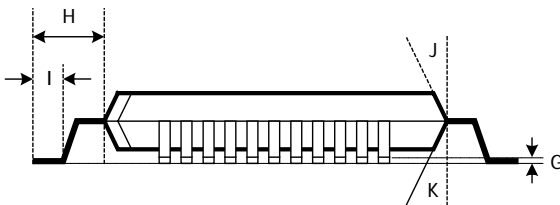
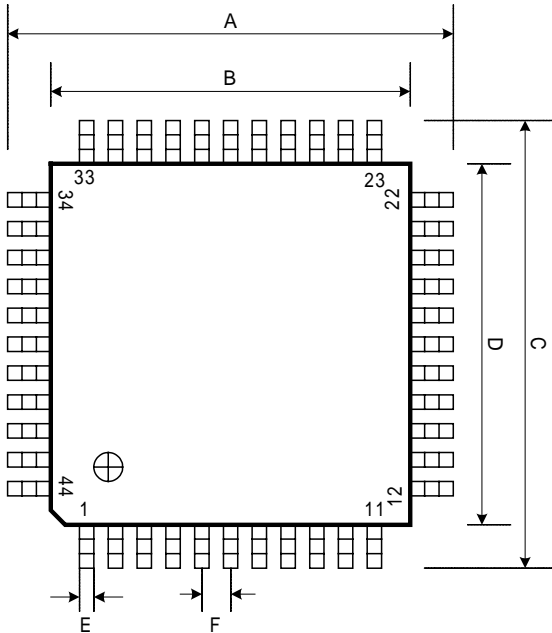

NOTE

Each lead centerline is located within 0.16mm of its true position (T.P.) at maximum material.

(Unit: mm)

Item	Millimeters
A	13.2 ± 0.2
B	10.0 ± 0.2
C	13.2 ± 0.2
D	10.0 ± 0.2
E	0.37(TYP.)
F	0.8 BSC
G	0.3 +0.2 -0.1
H	1.6
I	1.2 ± 0.15
J	12° ± 1°
K	12° ± 1°
L	1.7 MAX
M	1.4 ± 0.1
N	0° MIN
O	+3° +7° -3°



TP6317

1/4 TO 1/11-DUTY VFD CONTROLLER/DRIVER

48-Pin Plastic LQFP Short-Lead (Footprint = 2.0mm)

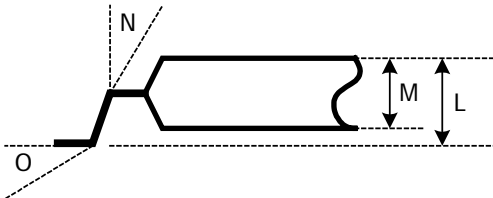
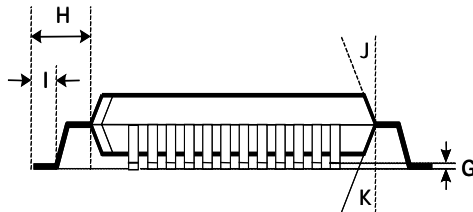
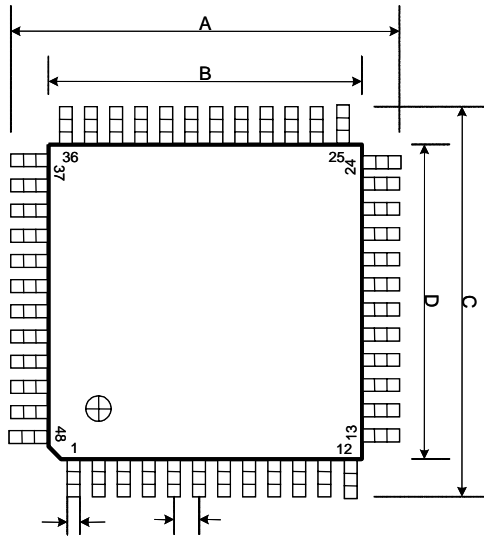

NOTE

Each lead centerline is located within 0.16mm of its true position (T.P.) at maximum material

(Unit: mm)

Item	Millimeters
A	9.0 ± 0.2
B	7.0 ± 0.2
C	9.0 ± 0.2
D	7.0 ± 0.2
E	0.22±0.05
F	0.5 BSC
G	0.2 +0.05 -0.05
H	1.0
I	0.6 ± 0.15
J	12° ± 1°
K	12° ± 1°
L	1.6 MAX
M	1.4 ± 0.1
N	0° MIN
O	+3° +7° -3°

Topro Technology Inc.

Headquarters

5 F, No. 10, Prosperity Road 1, Science-Based Industrial Park, Hsinchu 300, Taiwan, R.O.C
Tel.: 886-3-563-2515 Fax: 886-3-564-1728

Taipei Office

5 F, No.27, Min Chuan W. Rd. Taipei 104, Taiwan, R.O.C
Tel.: 886-2-2585-6858 Fax: 886-2-2594-1104

Shenzhen Office

Room 802, Tower A, World Trade Plaza, Fahong Rd., Fatian, Shenzhen, China
Tel.: 86-755-8367-9985 Fax: 86-755-8367-9518