

Super FAP-G Series

N-CHANNEL SILICON POWER MOSFET

Features

- High speed switching
- Low on-resistance
- No secondary breakdown
- Low driving power
- Avalanche-proof

Applications

- Switching regulators
- UPS (Uninterruptible Power Supply)
- DC-DC converters

Maximum ratings and characteristic Absolute maximum ratings

(Tc=25°C unless otherwise specified)

Item	Symbol	Ratings	Unit
Drain-source voltage	V _{DS}	500	V
Continuous drain current	I _D	±14	A
Pulsed drain current	I _{D(puls)}	±56	A
Gate-source voltage	V _{GS}	±30	V
Repetitive or non-repetitive	IAR *2	14	A
Maximum Avalanche Energy	EAS *1	188.2	mJ
Maximum Drain-Source dV/dt	dV _{DS} /dt	20	kV/μs
Peak Diode Recovery dV/dt	dV/dt *3	5	kV/μs
Max. power dissipation	P _D	T _a =25°C	2.02
		T _c =25°C	195
Operating and storage temperature range	T _{ch}	+150	°C
	T _{stg}	-55 to +150	°C

*1 L=1.76mH, V_{CC}=50V, See to Avalanche Energy Graph *2 T_{ch}≤150°C

*3 I_F≤I_D, -di/dt=50A/μs, V_{CC}≤BV_{DSS}, T_{ch}≤150°C

Electrical characteristics (T_c =25°C unless otherwise specified)

Item	Symbol	Test Conditions	Min.	Typ.	Max.	Units
Drain-source breakdown voltage	V _{(BR)DSS}	I _D =250μA V _{GS} =0V	500			V
Gate threshold voltage	V _{GS(th)}	I _D = 250μA V _{DS} =V _{GS}	3.0		5.0	V
Zero gate voltage drain current	I _{DSS}	V _{DS} =500V V _{GS} =0V	T _{ch} =25°C		25	μA
			T _{ch} =125°C		250	
Gate-source leakage current	I _{GSS}	V _{GS} =±30V V _{DS} =0V		10	100	nA
Drain-source on-state resistance	R _{DS(on)}	I _D =6A V _{GS} =10V		0.40	0.52	Ω
Forward transconductance	g _{fs}	I _D =6A V _{DS} =25V	5.5	11		S
Input capacitance	C _{iss}	V _{DS} =25V		1200	1800	pF
Output capacitance	C _{oss}	V _{GS} =0V		140	210	
Reverse transfer capacitance	C _{rss}	f=1MHz		6.0	9.0	
Turn-on time t _{on}	t _{d(on)}	V _{CC} =300V I _D =6A		17	26	ns
			V _{GS} =10V		15	
Turn-off time t _{off}	t _{d(off)}	R _{GS} =10 Ω		34	51	
			t _r		7	
Total Gate Charge	Q _G	V _{CC} =250V		30	45	nC
Gate-Source Charge	Q _{GS}	I _D =12A		10	15	
Gate-Drain Charge	Q _{GD}	V _{GS} =10V		11	16.5	
Avalanche capability	I _{AV}	L=1.76mH T _{ch} =25°C	14			A
Diode forward on-voltage	V _{SD}	I _F =12A V _{GS} =0V T _{ch} =25°C		1.00	1.50	V
Reverse recovery time	t _{rr}	I _F =12A V _{GS} =0V		0.7		μs
Reverse recovery charge	Q _{rr}	-di/dt=100A/μs T _{ch} =25°C		4.5		μC

Thermal characteristics

Item	Symbol	Test Conditions	Min.	Typ.	Max.	Units
Thermal resistance	R _{th(ch-c)}	channel to case			0.641	°C/W
	R _{th(ch-a)}	channel to ambient			62.0	°C/W

Outline Drawings [mm]

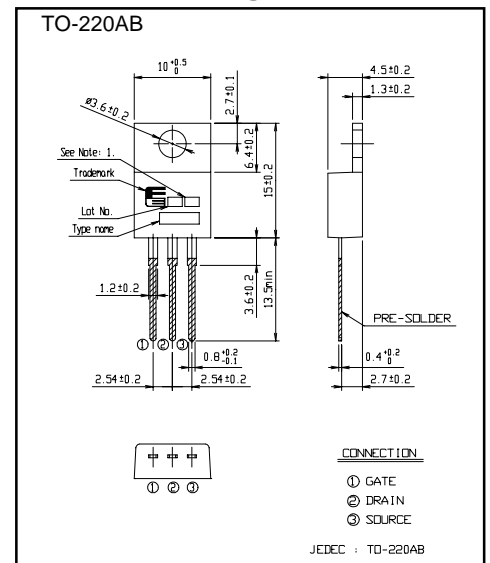

Equivalent circuit schematic

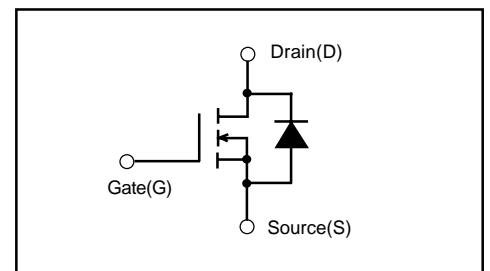

Characteristics

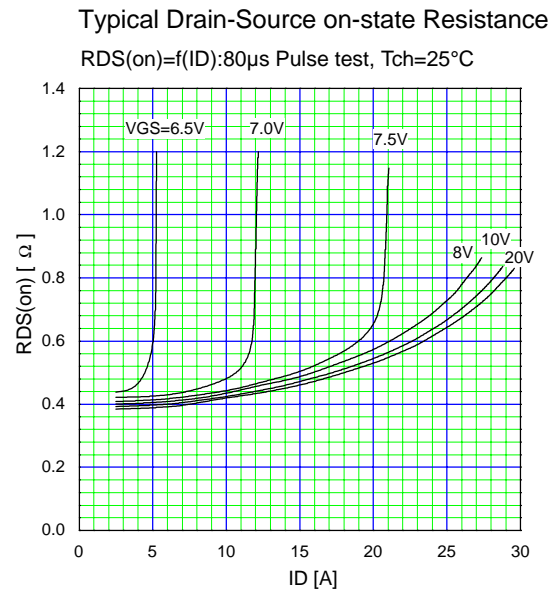
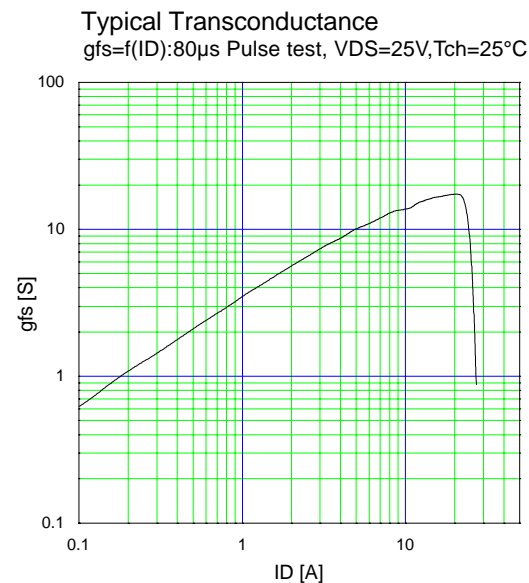
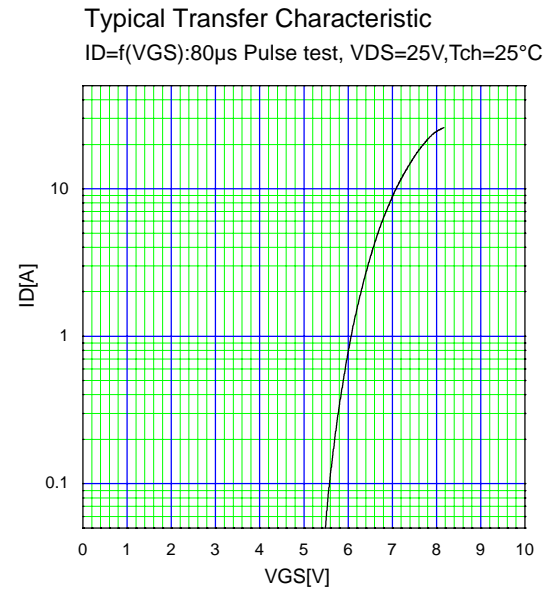
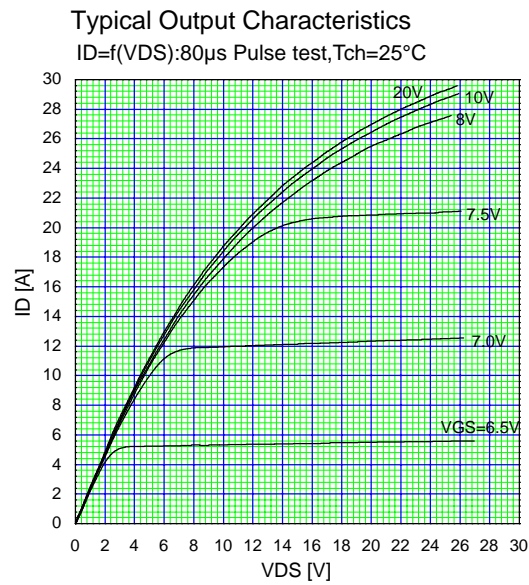
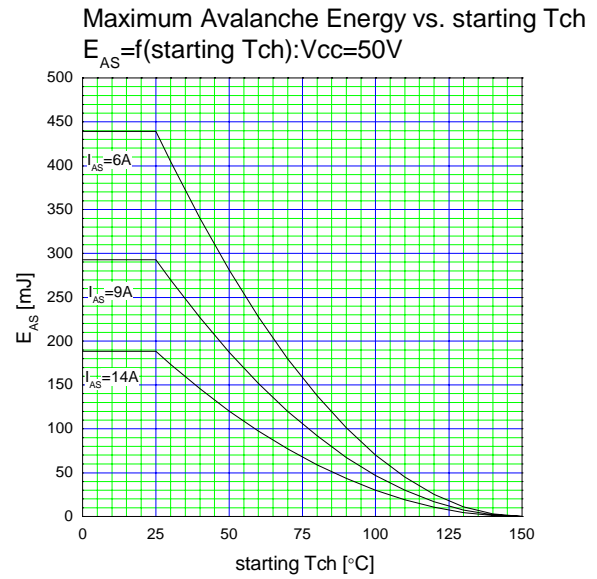
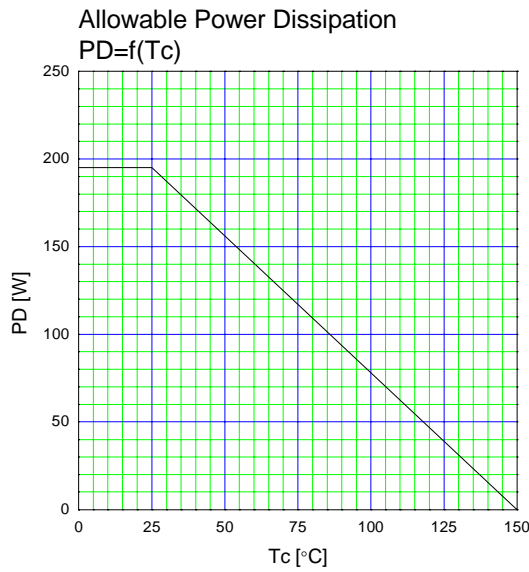

Drain-Source On-state Resistance

$R_{DS(on)}=f(T_{ch}):I_D=6A, V_{GS}=10V$

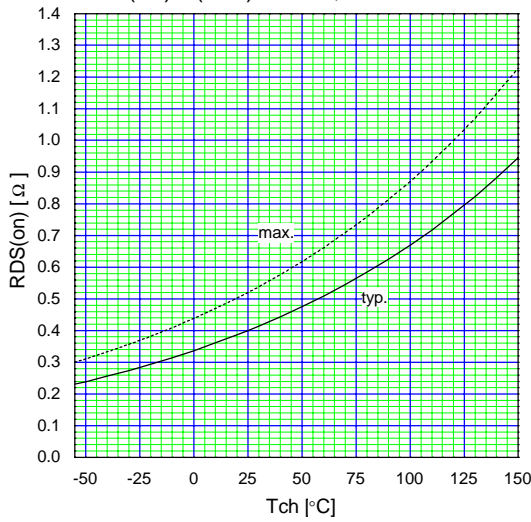

Gate Threshold Voltage vs. T_{ch}

$V_{GS(th)}=f(T_{ch}):V_{DS}=V_{GS}, I_D=250\mu A$

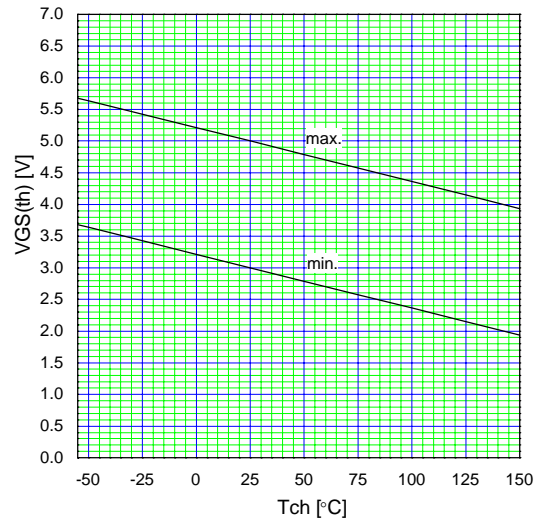

Typical Gate Charge Characteristics

$V_{GS}=f(Q_g):I_D=12A, T_{ch}=25^{\circ}C$

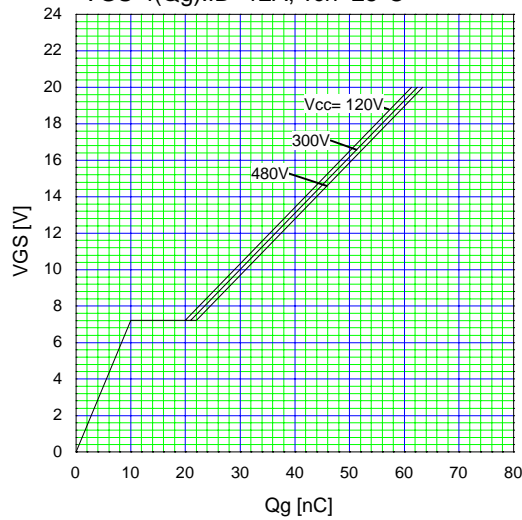

Typical Capacitance

$C=f(V_{DS}):V_{GS}=0V, f=1MHz$

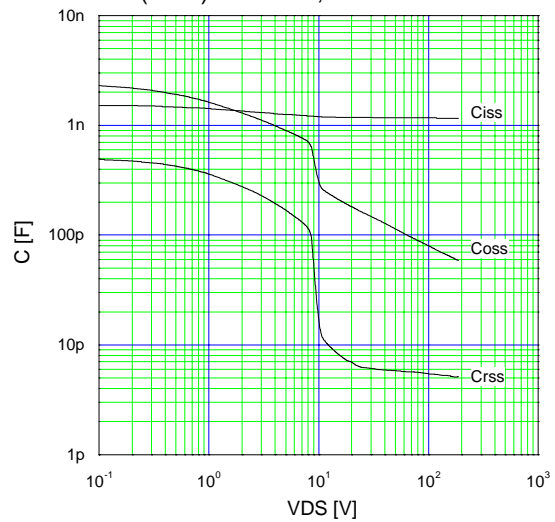

Typical Forward Characteristics of Reverse Diode

$I_F=f(V_{SD}):80\mu s$ Pulse test, $T_{ch}=25^{\circ}C$

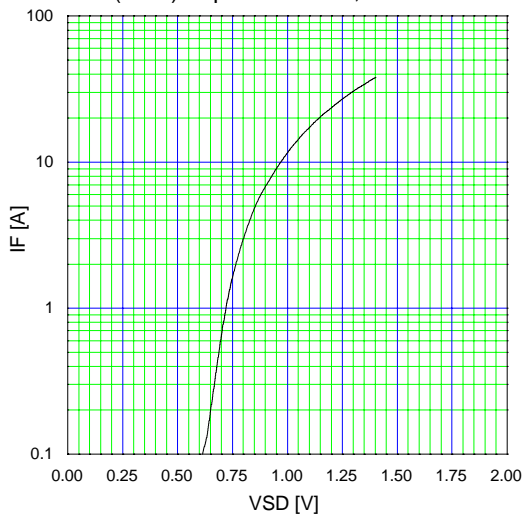

Typical Switching Characteristics vs. I_D

$t=f(I_D):V_{cc}=300V, V_{GS}=10V, R_G=10\Omega$

