



### HAOPIN MICROELECTRONICS CO.,LTD.

#### Description

Passivated high commutation triacs in a plastic envelope intended for use in circuits where high static and dynamic  $dV/dt$  and high  $dI/dt$  can occur. These devices will commutate the full rated ms current at the maximum rated junction temperature without the aid of a snubber.

<p>Symbol</p> 		<p>Simplified outline</p> 	
Pin	Description		
1	Main terminal 1 (T1)		
2	Main terminal 2 (T2)		
3	gate (G)		
TAB	isolated		

#### Applications:

- ◆ Motor control
- ◆ Industrial and domestic lighting
- ◆ Heating
- ◆ Static switching

#### Features

- ◆ Blocking voltage to 600 V
- ◆ On-state RMS current to 8 A

SYMBOL	PARAMETER	Value	Unit
$V_{DRM}$	Repetitive peak off-state voltages	600	V
$I_T (RMS)$	RMS on-state current (full sine wave)	8	A
$I_{TSM}$	Non-repetitive peak on-state current (full cycle, $T_j$ initial=25°C)	84	A

SYMBOL	PARAMETER	CONDITIONS	MIN	TYP	MAX	UNIT
$R_{th(j-c)}$	Junction to case(AC)		-	2.5	-	°C/W
$R_{th(j-a)}$	Junction to ambient		-	60	-	°C/W

### HAOPIN MICROELECTRONICS CO.,LTD.

Limiting values in accordance with the Maximum system(IEC 134)

SYMBOL	PARAMETER	CONDITIONS	MIN	Value	UNIT		
$V_{DRM}/V_{RRM}$	Repetitive peak off-state Voltages		-	600	V		
$I_{T(RMS)}$	RMS on-state current	Full sine wave; $T_c=100^\circ\text{C}$	-	8	A		
$I_{TSM}$	Non repetitive surge peak on-state current	full cycle, $T_j$ initial= $25^\circ\text{C}$	F=50Hz	t=20ms	-	80	A
			F=60Hz	t=16.7ms	-	84	A
$I^2t$	$I^2t$ value for fusing	tp=10ms	-	36	A <sup>2</sup> S		
di/dt	Critical rate of rise of on-state current	$I_G=2x I_{GT}$ , tr<=100ns	F=120Hz	$T_j=125^\circ\text{C}$	-	50	A/ $\mu\text{s}$
$I_{GM}$	Peak gate current		tp=20us	$T_j=125^\circ\text{C}$	-	4	A
$I_{DRM}$ $I_{RRM}$	$V_{DRM}=V_{RRM}$			$T_j=25^\circ\text{C}$	-	5	$\mu\text{A}$
				$T_j=125^\circ\text{C}$	-	1	mA
$P_{G(AV)}$	Average gate power dissipation			$T_j=125^\circ\text{C}$	-	1	W
$T_{stg}$	Storage junction temperature range		-40	150	$^\circ\text{C}$		
$T_j$	Operating junction temperature range		-40	125	$^\circ\text{C}$		

$T_j=25^\circ\text{C}$  unless otherwise stated

SYMBOL	PARAMETER	CONDITIONS	MIN	TYP	MAX	UNIT	
Static characteristics							
$I_{GT}(1)$ $V_{GT}$		$V_D=12\text{V}$ ; $R_L=30\ \Omega$	I-II-III	-	-	50	mA
			I-II-III	-	-	1.3	V
$I_L$		$I_G=1.2 I_{GT}$	I-III	-	-	70	mA
			II	-	-	80	mA
$I_H(2)$		$I_T=100\text{mA}$	-	-	50	mA	
$V_{GD}$		$V_D=V_{DRM}$ $R_L=3.3\text{K}\ \Omega$ $T_j=125^\circ\text{C}$	I-II-III	0.2	-	-	V
dV/dt(2)		$V_D=67\%V_{DRM}$ gate open; $T_j=125^\circ\text{C}$		1000	-	-	V/us
(di/dt)c(2)		without sunbber $T_j=125^\circ\text{C}$		7	-	-	V/us

#### Dynamic Characteristics

$V_{TM}(2)$	$I_{TM}=11\text{A}$ tp=380us	$T_j=25^\circ\text{C}$	-	-	1.55	V
$V_{to}(2)$ $R_g(2)$	Threshold voltage Dynamic resistance	$T_j=125^\circ\text{C}$ $T_j=125^\circ\text{C}$	-	-	0.85 50	V m $\Omega$

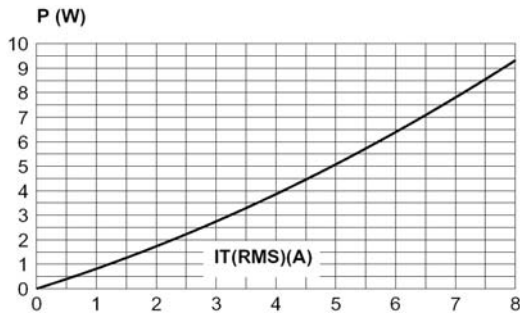
Note1: minimum  $I_{GT}$  is guaranteed at 5% of  $I_{GT}$  max.

Note2: for both polarities of A2 referenced to A1.

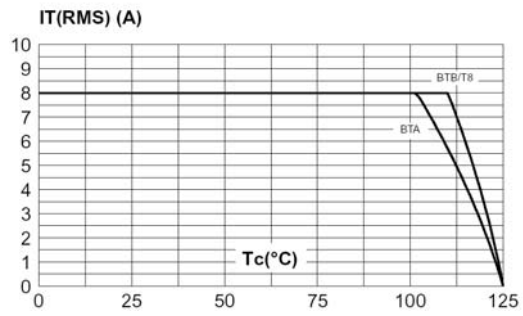
### HAOPIN MICROELECTRONICS CO.,LTD.

#### Description

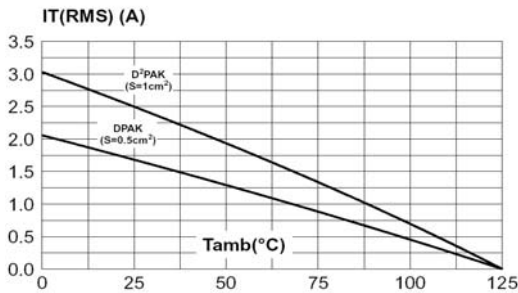
**Fig. 1:** Maximum power dissipation versus RMS on-state current (full cycle).



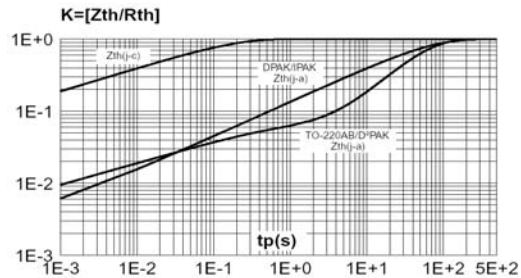
**Fig. 2-1:** RMS on-state current versus case temperature (full cycle).



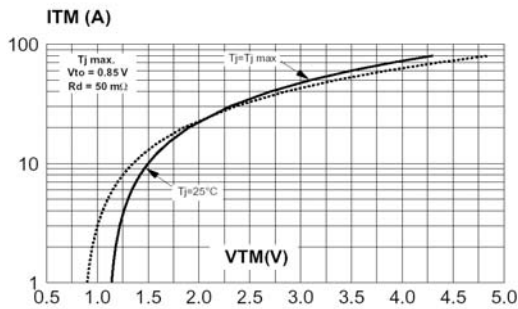
**Fig. 2-2:** RMS on-state current versus ambient temperature (printed circuit board FR4, copper thickness: 35µm), full cycle.



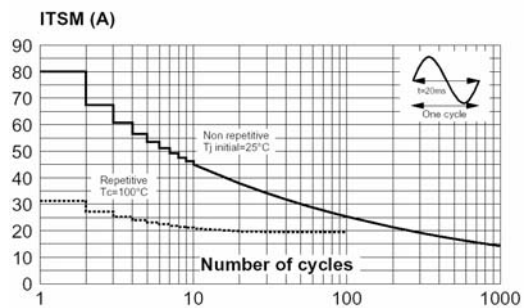
**Fig. 3:** Relative variation of thermal impedance versus pulse duration.



**Fig. 4:** On-state characteristics (maximum values).

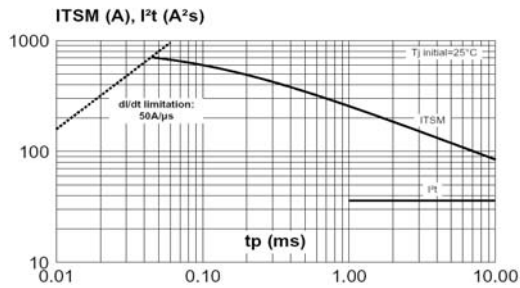


**Fig. 5:** Surge peak on-state current versus number of cycles.

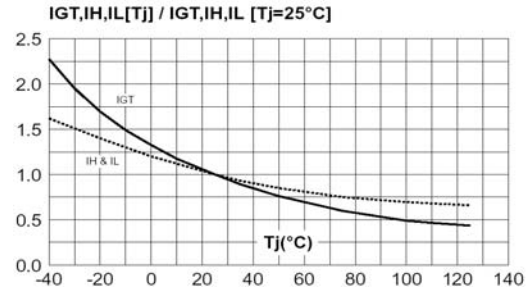


#### Description

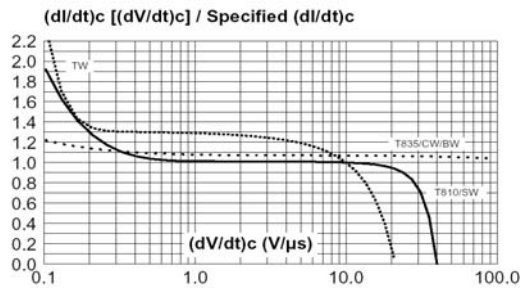
**Fig. 6:** Non-repetitive surge peak on-state current for a sinusoidal pulse with width  $t_p < 10\text{ms}$ , and corresponding value of  $I^2t$ .



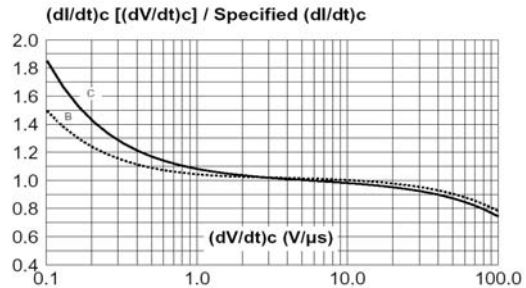
**Fig. 7:** Relative variation of gate trigger current, holding current and latching current versus junction temperature (typical values).



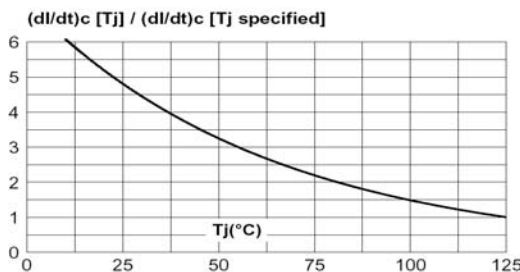
**Fig. 8-1:** Relative variation of critical rate of decrease of main current versus  $(dV/dt)_c$  (typical values). Snubberless & Logic Level Types



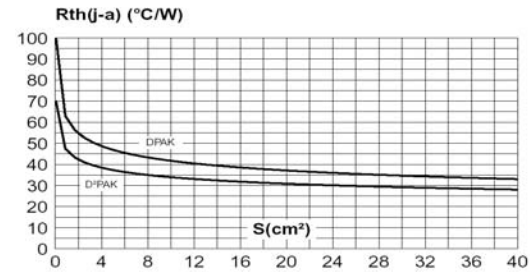
**Fig. 8-2:** Relative variation of critical rate of decrease of main current versus  $(dV/dt)_c$  (typical values). Standard Types



**Fig. 9:** Relative variation of critical rate of decrease of main current versus junction temperature.

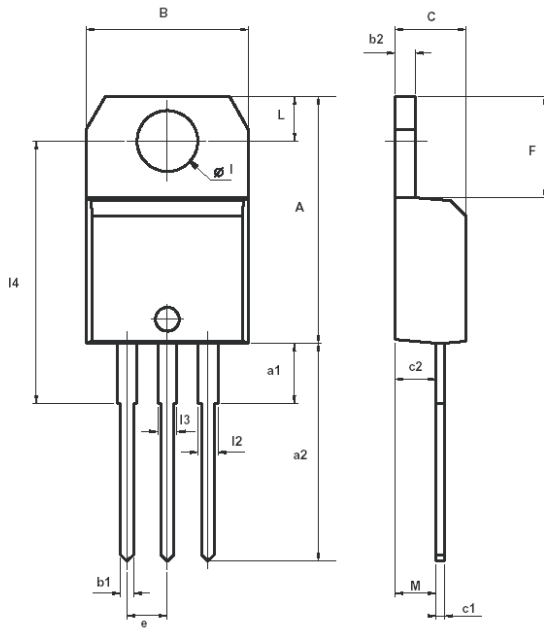


**Fig. 10:** DPAK and D<sup>2</sup>PAK Thermal resistance junction to ambient versus copper surface under tab (printed circuit board FR4, copper thickness: 35 µm).



#### MECHANICAL DATA

Dimensions in mm  
Net Mass: 2 g



REF.	DIMENSIONS					
	Millimeters			Inches		
	Min.	Typ.	Max.	Min.	Typ.	Max.
A	15.20		15.90	0.598		0.625
a1		3.75			0.147	
a2	13.00		14.00	0.511		0.551
B	10.00		10.40	0.393		0.409
b1	0.61		0.88	0.024		0.034
b2	1.23		1.32	0.048		0.051
C	4.40		4.60	0.173		0.181
c1	0.49		0.70	0.019		0.027
c2	2.40		2.72	0.094		0.107
e	2.40		2.70	0.094		0.106
F	6.20		6.60	0.244		0.259
I	3.75		3.85	0.147		0.151
I4	15.80	16.40	16.80	0.622	0.646	0.661
L	2.65		2.95	0.104		0.116
I2	1.14		1.70	0.044		0.066
I3	1.14		1.70	0.044		0.066
M		2.60			0.102	