



# STB13NM60N, STD13NM60N

N-channel 600 V, 0.28  $\Omega$  typ., 11 A MDmesh™ II Power MOSFET in D<sup>2</sup>PAK and DPAK packages

Datasheet — production data

## Features

Order codes	V <sub>DSS</sub> (@T <sub>jmax</sub> )	R <sub>DS(on)</sub> max	I <sub>D</sub>
STB13NM60N	650 V	< 0.36 $\Omega$	11 A
STD13NM60N	650 V	< 0.36 $\Omega$	11 A

- 100% avalanche tested
- Low input capacitance and gate charge
- Low gate input resistance

## Applications

- Switching applications

## Description

These devices are N-channel Power MOSFETs developed using the second generation of MDmesh™ technology. This revolutionary Power MOSFET associates a vertical structure to the company's strip layout to yield one of the world's lowest on-resistance and gate charge. It is therefore suitable for the most demanding high efficiency converters.

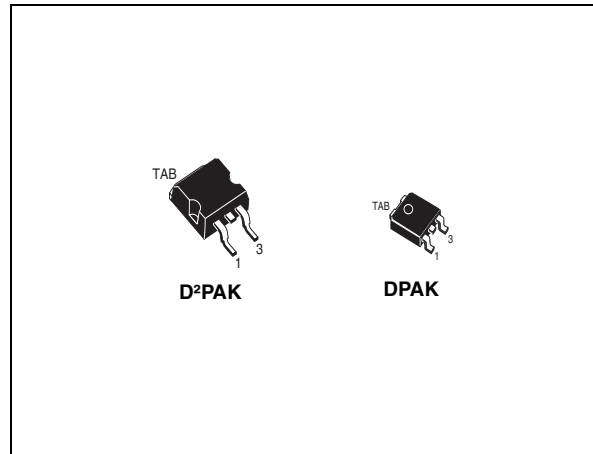


Figure 1. Internal schematic diagram

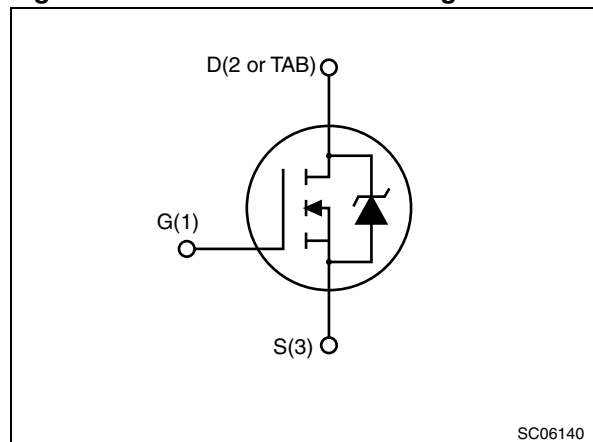


Table 1. Device summary

Order codes	Marking	Packages	Packaging
STB13NM60N	13NM60N	D <sup>2</sup> PAK	Tape and reel
STD13NM60N		DPAK	

# Contents

<b>1</b>	<b>Electrical ratings</b> .....	<b>3</b>
<b>2</b>	<b>Electrical characteristics</b> .....	<b>4</b>
2.1	Electrical characteristics (curves) .....	6
<b>3</b>	<b>Test circuits</b> .....	<b>9</b>
<b>4</b>	<b>Package mechanical data</b> .....	<b>10</b>
<b>5</b>	<b>Packaging mechanical data</b> .....	<b>15</b>
<b>6</b>	<b>Revision history</b> .....	<b>18</b>

# 1 Electrical ratings

**Table 2. Absolute maximum ratings**

Symbol	Parameter	Value	Unit
$V_{DS}$	Drain-source voltage	600	V
$V_{GS}$	Gate-source voltage	$\pm 25$	V
$I_D$	Drain current (continuous) at $T_C = 25\text{ }^\circ\text{C}$	11	A
$I_D$	Drain current (continuous) at $T_C = 100\text{ }^\circ\text{C}$	6.93	A
$I_{DM}^{(1)}$	Drain current (pulsed)	44	A
$P_{TOT}$	Total dissipation at $T_C = 25\text{ }^\circ\text{C}$	90	W
$dv/dt^{(2)}$	Peak diode recovery voltage slope	15	V/ns
$T_{stg}$	Storage temperature	- 55 to 150	$^\circ\text{C}$
$T_j$	Max. operating junction temperature	150	$^\circ\text{C}$

1. Pulse width limited by safe operating area

2.  $I_{SD} \leq 11\text{ A}$ ,  $di/dt \leq 400\text{ A}/\mu\text{s}$ ,  $V_{DS\text{ peak}} \leq V_{(BR)DSS}$ ,  $V_{DD} = 80\% V_{(BR)DSS}$ .

**Table 3. Thermal data**

Symbol	Parameter	Value		Unit
		D <sup>2</sup> PAK	DPAK	
$R_{thj\text{-case}}$	Thermal resistance junction-case max	1.39		$^\circ\text{C}/\text{W}$
$R_{thj\text{-pcb}}$	Thermal resistance junction-pcb max	30	50	$^\circ\text{C}/\text{W}$

**Table 4. Avalanche characteristics**

Symbol	Parameter	Value	Unit
$I_{AS}$	Avalanche current, repetitive or not-repetitive (pulse width limited by $T_j$ max)	3.5	A
$E_{AS}$	Single pulse avalanche energy (starting $T_j=25\text{ }^\circ\text{C}$ , $I_D=I_{AS}$ , $V_{DD}=50\text{ V}$ )	200	mJ

## 2 Electrical characteristics

( $T_{CASE} = 25\text{ °C}$  unless otherwise specified)

**Table 5. On/off states**

Symbol	Parameter	Test conditions	Min.	Typ.	Max.	Unit
$V_{(BR)DSS}$	Drain-source breakdown voltage ( $V_{GS} = 0$ )	$I_D = 1\text{ mA}$	600			V
$I_{DSS}$	Zero gate voltage drain current ( $V_{GS} = 0$ )	$V_{DS} = 600\text{ V}$ $V_{DS} = 600\text{ V}, T_C = 125\text{ °C}$			1 100	$\mu\text{A}$ $\mu\text{A}$
$I_{GSS}$	Gate-body leakage current ( $V_{DS} = 0$ )	$V_{GS} = \pm 25\text{ V}$			$\pm 0.1$	$\mu\text{A}$
$V_{GS(th)}$	Gate threshold voltage	$V_{DS} = V_{GS}, I_D = 250\text{ }\mu\text{A}$	2	3	4	V
$R_{DS(on)}$	Static drain-source on-resistance	$V_{GS} = 10\text{ V}, I_D = 5.5\text{ A}$		0.28	0.36	$\Omega$

**Table 6. Dynamic**

Symbol	Parameter	Test conditions	Min.	Typ.	Max.	Unit
$C_{iss}$	Input capacitance	$V_{DS} = 50\text{ V}, f = 1\text{ MHz},$ $V_{GS} = 0$	-	790	-	pF
$C_{oss}$	Output capacitance			60		pF
$C_{rss}$	Reverse transfer capacitance			3.6		pF
$C_{oss\text{ eq.}}^{(1)}$	Equivalent output capacitance	$V_{GS} = 0, V_{DS} = 0\text{ to }480\text{ V}$	-	135	-	pF
$Q_g$	Total gate charge	$V_{DD} = 480\text{ V}, I_D = 11\text{ A},$ $V_{GS} = 10\text{ V},$ <i>(see Figure 16)</i>	-	27	-	nC
$Q_{gs}$	Gate-source charge			4		nC
$Q_{gd}$	Gate-drain charge			14		nC
$R_G$	Gate input resistance	$f = 1\text{ MHz}$ open drain	-	4.7	-	$\Omega$

1.  $C_{oss\text{ eq.}}$  is defined as a constant equivalent capacitance giving the same charging time as  $C_{oss}$  when  $V_{DS}$  increases from 0 to 80%  $V_{DS}$

**Table 7. Switching times**

Symbol	Parameter	Test conditions	Min.	Typ.	Max.	Unit	
$t_{d(on)}$	Turn-on delay time	$V_{DD} = 300\text{ V}$ , $I_D = 5.5\text{ A}$ $R_G = 4.7\ \Omega$ , $V_{GS} = 10\text{ V}$ (see Figure 15)		3		ns	
$t_r$	Rise time			8		ns	
$t_{d(off)}$	Turn-off delay time				30		ns
$t_f$	Fall time				10		ns

**Table 8. Source drain diode**

Symbol	Parameter	Test conditions	Min	Typ.	Max.	Unit
$I_{SD}$	Source-drain current				11	A
$I_{SDM}^{(1)}$	Source-drain current (pulsed)		-		44	A
$V_{SD}^{(2)}$	Forward on voltage	$I_{SD} = 11\text{ A}$ , $V_{GS} = 0$	-		1.5	V
$t_{rr}$	Reverse recovery time	$I_{SD} = 11\text{ A}$ , $di/dt = 100\text{ A}/\mu\text{s}$ $V_{DD} = 100\text{ V}$ (see Figure 17)		230		ns
$Q_{rr}$	Reverse recovery charge			2		$\mu\text{C}$
$I_{RRM}$	Reverse recovery current				18	A
$t_{rr}$	Reverse recovery time	$I_{SD} = 11\text{ A}$ , $di/dt = 100\text{ A}/\mu\text{s}$ $V_{DD} = 100\text{ V}$ , $T_j = 150\text{ }^\circ\text{C}$ (see Figure 17)		290		ns
$Q_{rr}$	Reverse recovery charge			190		$\mu\text{C}$
$I_{RRM}$	Reverse recovery current				17	A

1. Pulse width limited by safe operating area

2. Pulsed: pulse duration = 300  $\mu\text{s}$ , duty cycle 1.5%

## 2.1 Electrical characteristics (curves)

Figure 2. Safe operating area for D<sup>2</sup>PAK

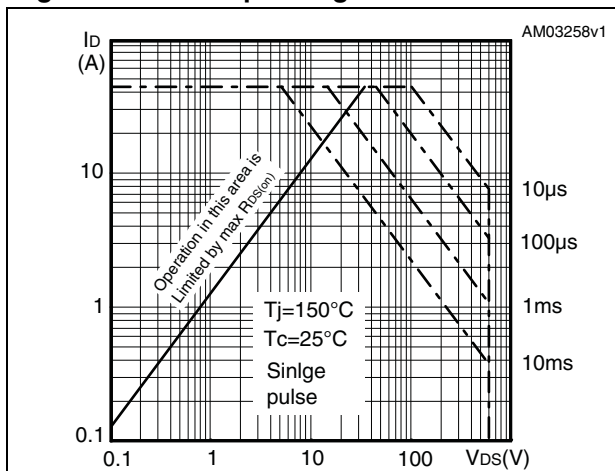


Figure 3. Thermal impedance for D<sup>2</sup>PAK

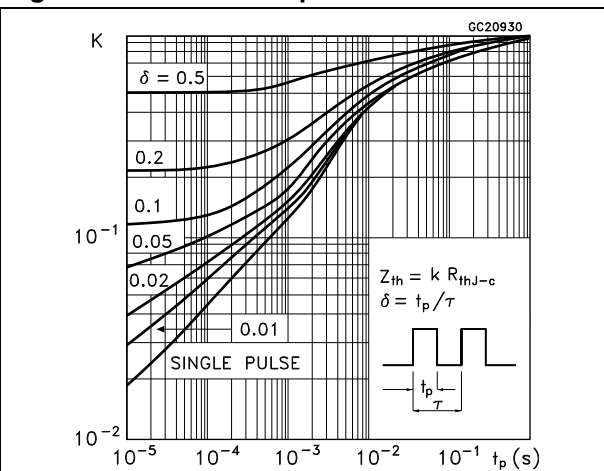


Figure 4. Safe operating area for DPAK

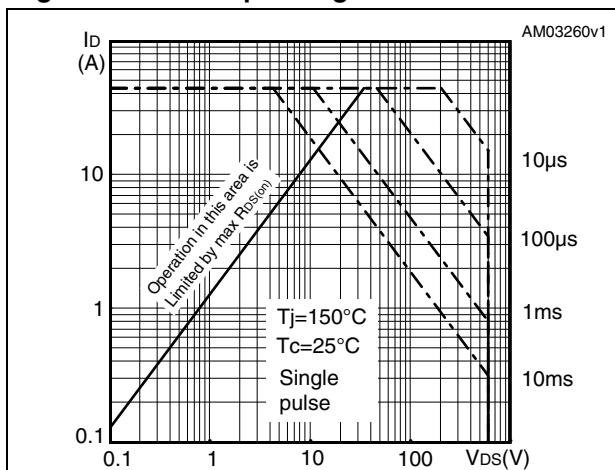


Figure 5. Thermal impedance for DPAK

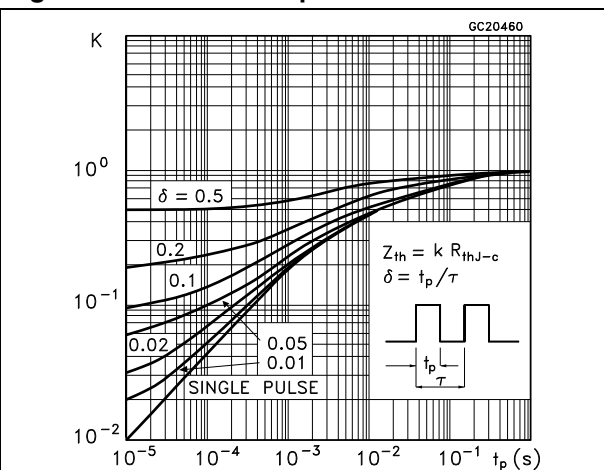


Figure 6. Output characteristics

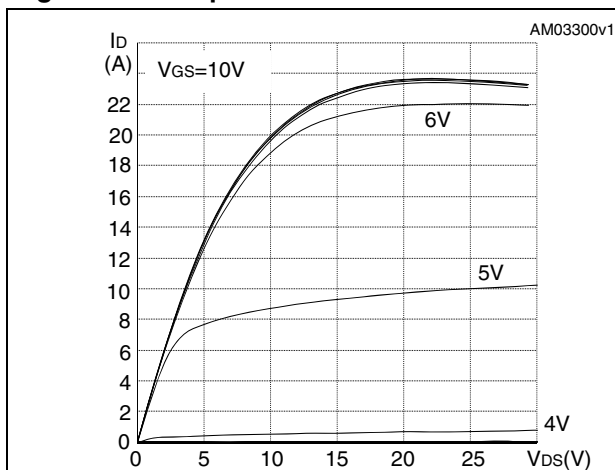


Figure 7. Transfer characteristics

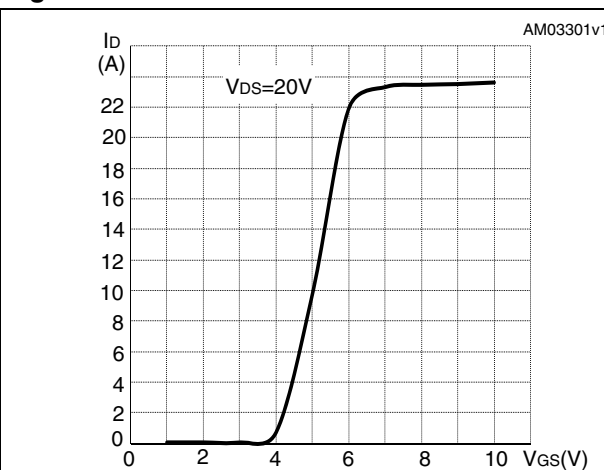


Figure 8. Normalized  $V_{DS}$  vs temperature

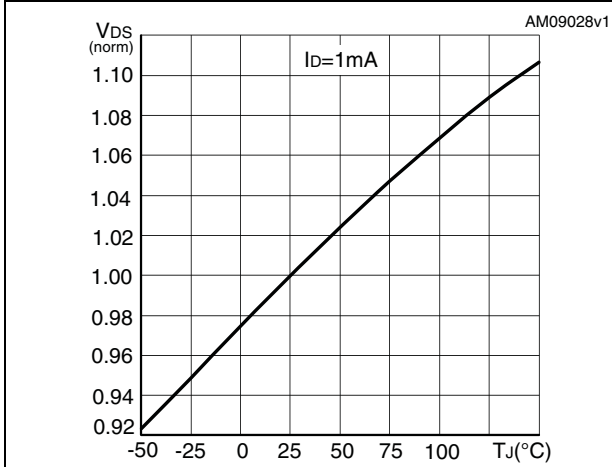


Figure 9. Static drain-source on-resistance

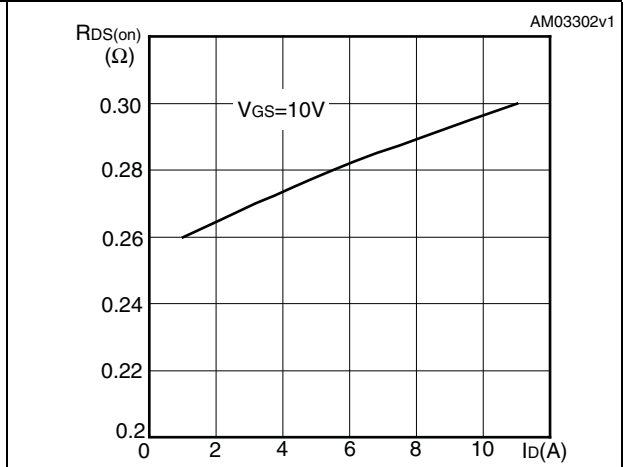


Figure 10. Gate charge vs gate-source voltage

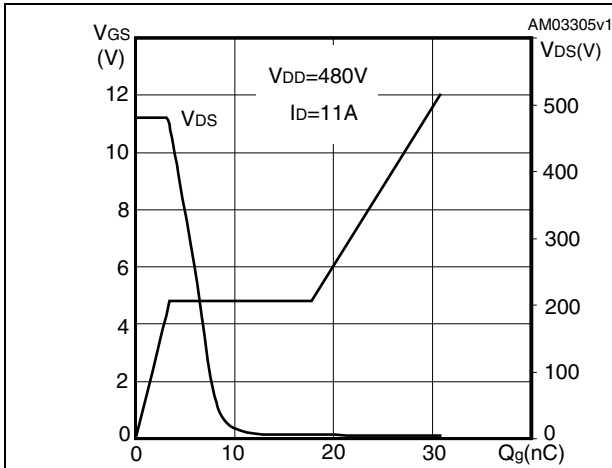


Figure 11. Capacitance variations

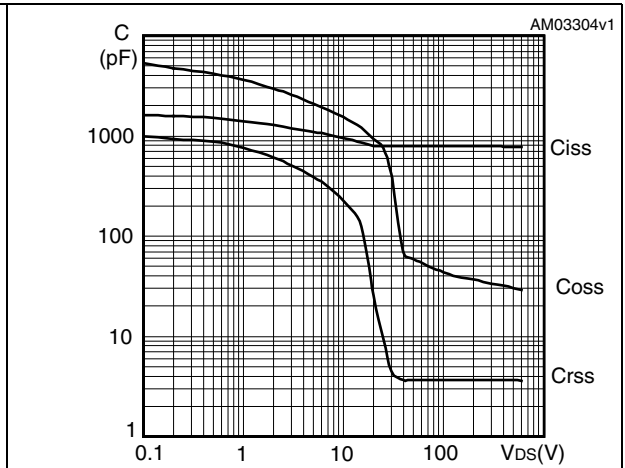


Figure 12. Normalized gate threshold voltage vs temperature

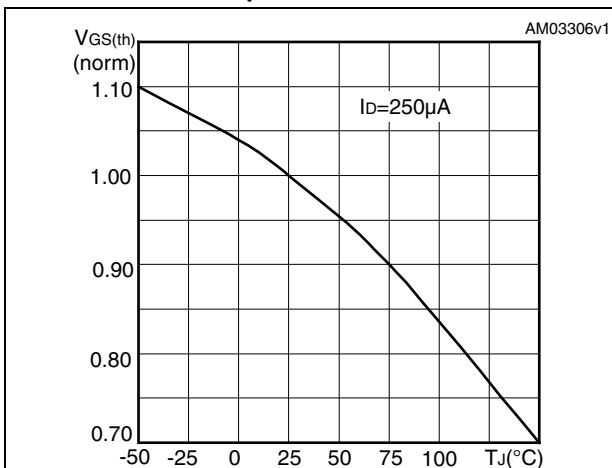


Figure 13. Normalized on-resistance vs temperature

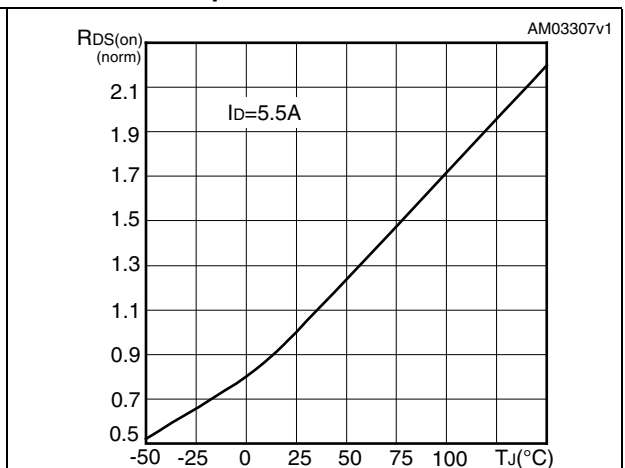
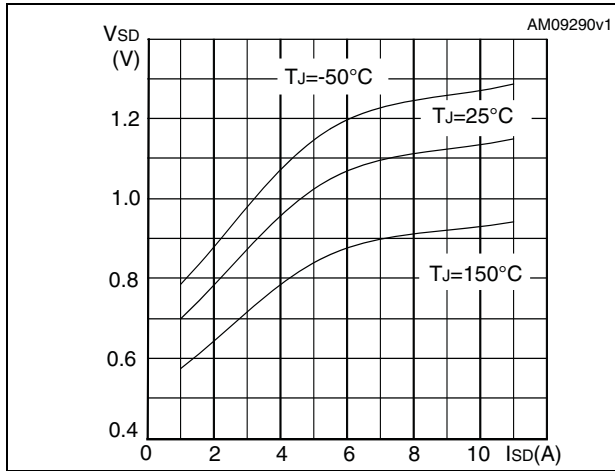


Figure 14. Source-drain diode forward characteristics





### 3 Test circuits

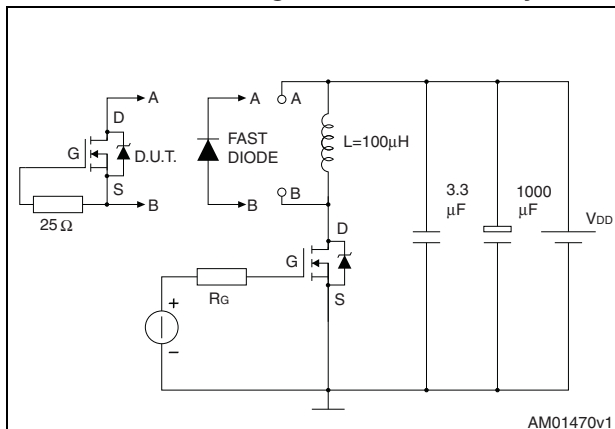
**Figure 15. Switching times test circuit for resistive load**



**Figure 16. Gate charge test circuit**



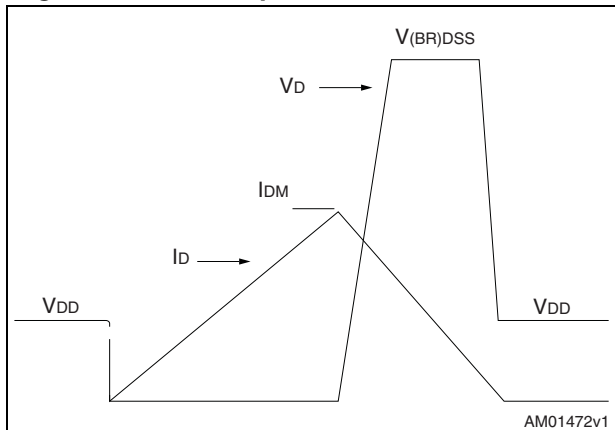
**Figure 17. Test circuit for inductive load switching and diode recovery times**



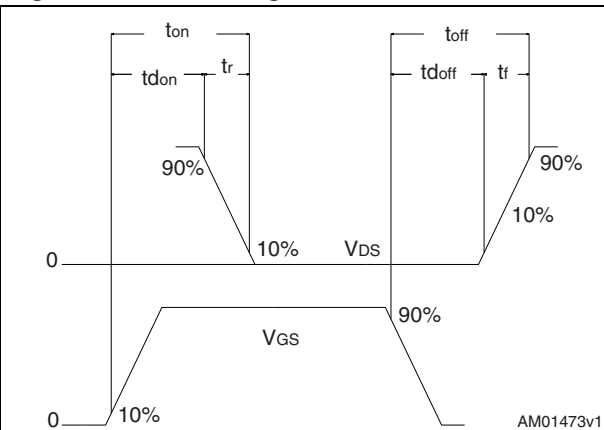
**Figure 18. Unclamped inductive load test circuit**



**Figure 19. Unclamped inductive waveform**



**Figure 20. Switching time waveform**



## 4 Package mechanical data

In order to meet environmental requirements, ST offers these devices in different grades of ECOPACK® packages, depending on their level of environmental compliance. ECOPACK® specifications, grade definitions and product status are available at: [www.st.com](http://www.st.com). ECOPACK is an ST trademark.

Table 9. D<sup>2</sup>PAK (TO-263) mechanical data

Dim.	mm		
	Min.	Typ.	Max.
A	4.40		4.60
A1	0.03		0.23
b	0.70		0.93
b2	1.14		1.70
c	0.45		0.60
c2	1.23		1.36
D	8.95		9.35
D1	7.50		
E	10		10.40
E1	8.50		
e		2.54	
e1	4.88		5.28
H	15		15.85
J1	2.49		2.69
L	2.29		2.79
L1	1.27		1.40
L2	1.30		1.75
R		0.4	
V2	0°		8°

Figure 21. D<sup>2</sup>PAK (TO-263) drawing

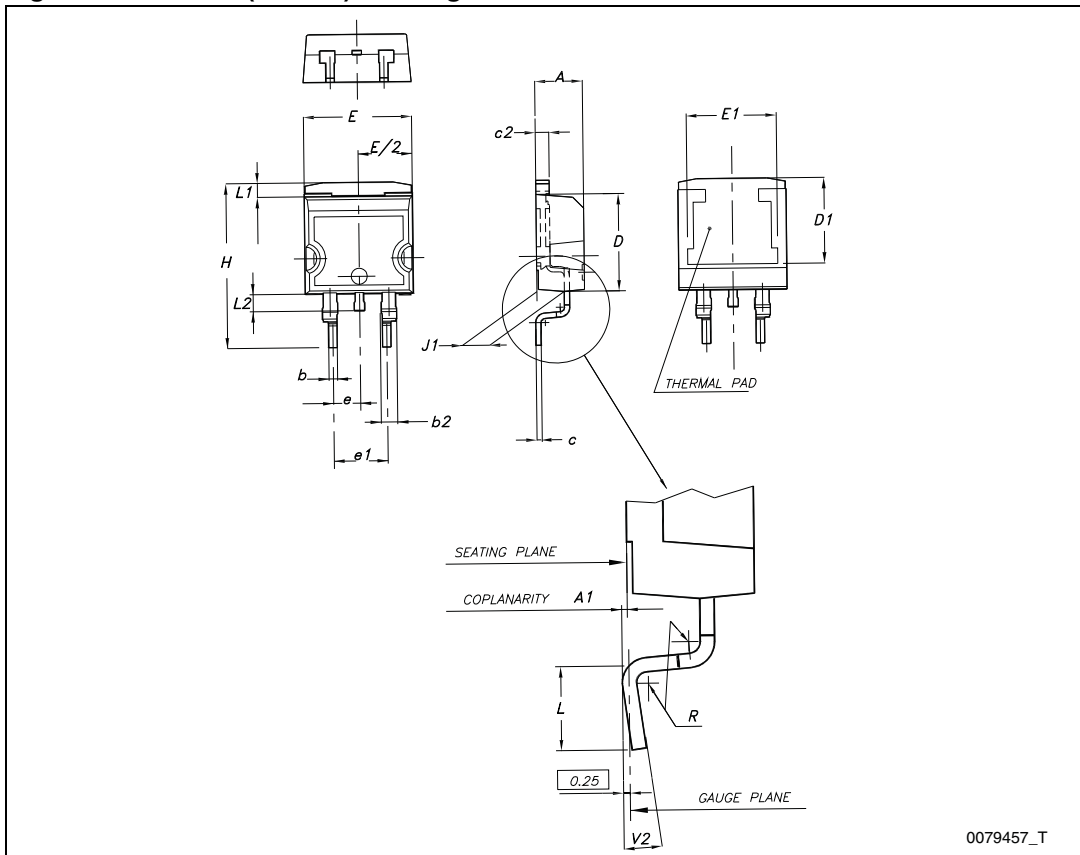
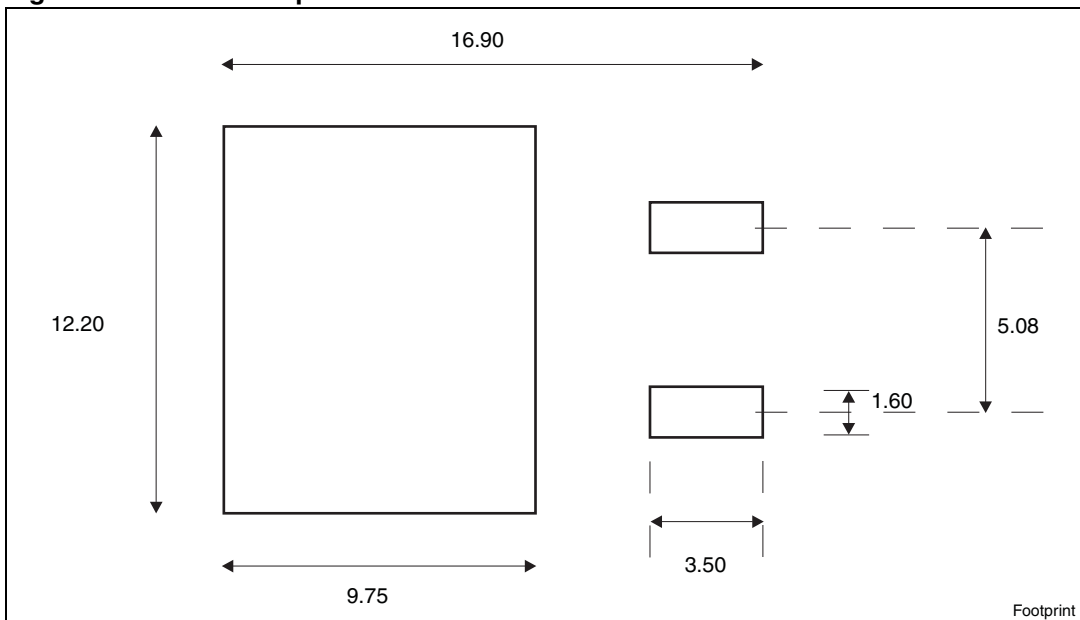


Figure 22. D<sup>2</sup>PAK footprint<sup>(a)</sup>



a. All dimensions are in millimeters

Table 10. DPAK (TO-252) mechanical data

Dim.	mm		
	Min.	Typ.	Max.
A	2.20		2.40
A1	0.90		1.10
A2	0.03		0.23
b	0.64		0.90
b4	5.20		5.40
c	0.45		0.60
c2	0.48		0.60
D	6.00		6.20
D1		5.10	
E	6.40		6.60
E1		4.70	
e		2.28	
e1	4.40		4.60
H	9.35		10.10
L	1		
L1		2.80	
L2		0.80	
L4	0.60		1
R		0.20	
V2	0°		8°

Figure 23. DPAK (TO-252) drawing

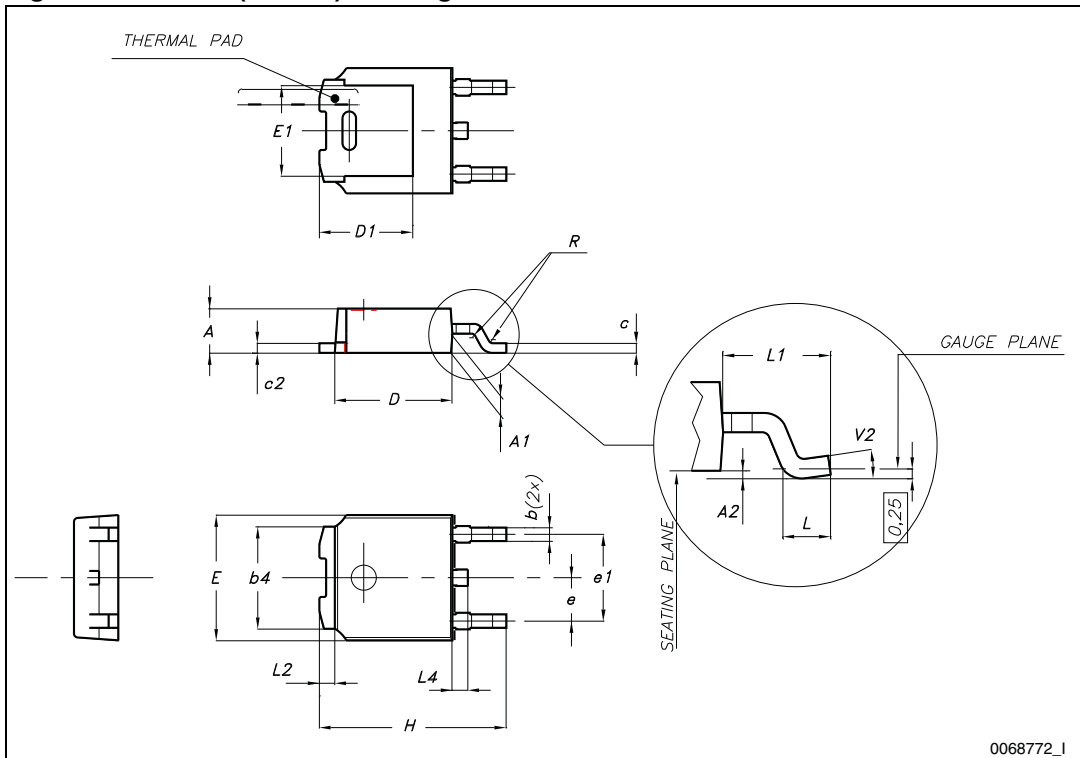
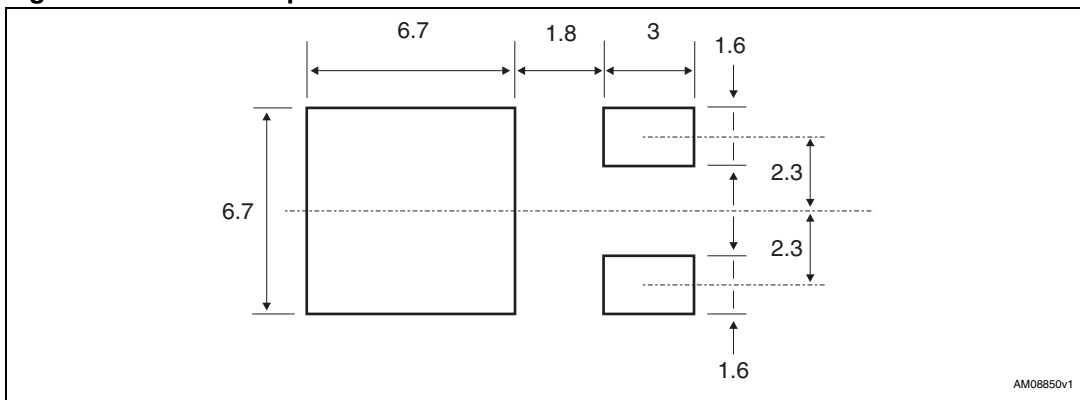


Figure 24. DPAK footprint<sup>(b)</sup>



b. All dimensions are in millimeters

## 5 Packaging mechanical data

Table 11. D<sup>2</sup>PAK (TO-263) tape and reel mechanical data

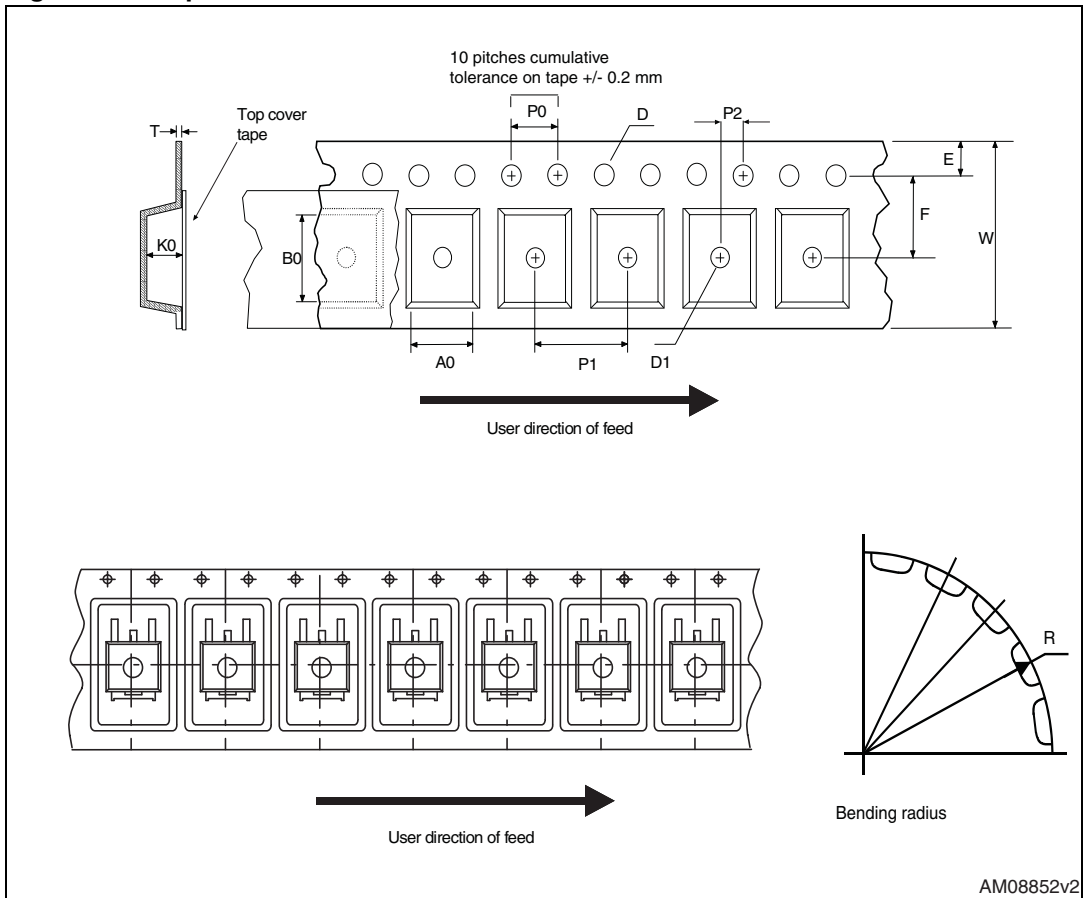
Tape			Reel		
Dim.	mm		Dim.	mm	
	Min.	Max.		Min.	Max.
A0	10.5	10.7	A		330
B0	15.7	15.9	B	1.5	
D	1.5	1.6	C	12.8	13.2
D1	1.59	1.61	D	20.2	
E	1.65	1.85	G	24.4	26.4
F	11.4	11.6	N	100	
K0	4.8	5.0	T		30.4
P0	3.9	4.1			
P1	11.9	12.1		Base qty	1000
P2	1.9	2.1		Bulk qty	1000
R	50				
T	0.25	0.35			
W	23.7	24.3			

Table 12. DPAK (TO-252) tape and reel mechanical data

Tape			Reel		
Dim.	mm		Dim.	mm	
	Min.	Max.		Min.	Max.
A0	6.8	7	A		330
B0	10.4	10.6	B	1.5	
B1		12.1	C	12.8	13.2
D	1.5	1.6	D	20.2	
D1	1.5		G	16.4	18.4
E	1.65	1.85	N	50	
F	7.4	7.6	T		22.4
K0	2.55	2.75			
P0	3.9	4.1	Base qty.		2500
P1	7.9	8.1	Bulk qty.		2500
P2	1.9	2.1			
R	40				
T	0.25	0.35			
W	15.7	16.3			

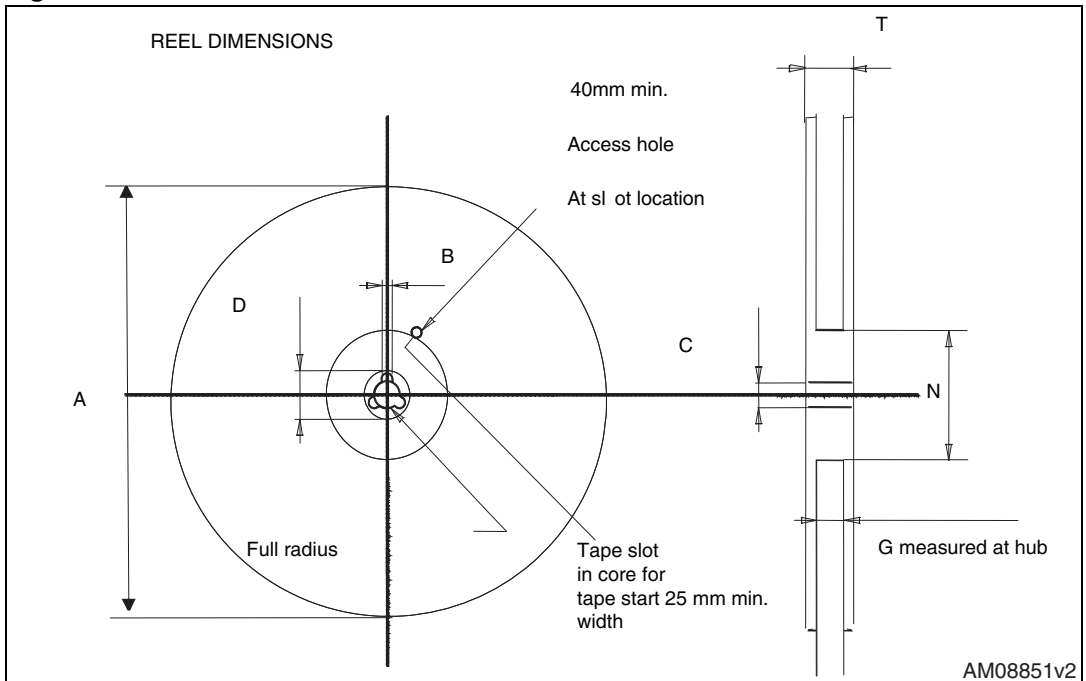


Figure 25. Tape



AM08852v2

Figure 26. Reel



AM08851v2

## 6 Revision history

**Table 13. Document revision history**

Date	Revision	Changes
18-Dec-2012	1	First release

**Please Read Carefully:**

Information in this document is provided solely in connection with ST products. STMicroelectronics NV and its subsidiaries ("ST") reserve the right to make changes, corrections, modifications or improvements, to this document, and the products and services described herein at any time, without notice.

All ST products are sold pursuant to ST's terms and conditions of sale.

Purchasers are solely responsible for the choice, selection and use of the ST products and services described herein, and ST assumes no liability whatsoever relating to the choice, selection or use of the ST products and services described herein.

No license, express or implied, by estoppel or otherwise, to any intellectual property rights is granted under this document. If any part of this document refers to any third party products or services it shall not be deemed a license grant by ST for the use of such third party products or services, or any intellectual property contained therein or considered as a warranty covering the use in any manner whatsoever of such third party products or services or any intellectual property contained therein.

**UNLESS OTHERWISE SET FORTH IN ST'S TERMS AND CONDITIONS OF SALE ST DISCLAIMS ANY EXPRESS OR IMPLIED WARRANTY WITH RESPECT TO THE USE AND/OR SALE OF ST PRODUCTS INCLUDING WITHOUT LIMITATION IMPLIED WARRANTIES OF MERCHANTABILITY, FITNESS FOR A PARTICULAR PURPOSE (AND THEIR EQUIVALENTS UNDER THE LAWS OF ANY JURISDICTION), OR INFRINGEMENT OF ANY PATENT, COPYRIGHT OR OTHER INTELLECTUAL PROPERTY RIGHT.**

**UNLESS EXPRESSLY APPROVED IN WRITING BY TWO AUTHORIZED ST REPRESENTATIVES, ST PRODUCTS ARE NOT RECOMMENDED, AUTHORIZED OR WARRANTED FOR USE IN MILITARY, AIR CRAFT, SPACE, LIFE SAVING, OR LIFE SUSTAINING APPLICATIONS, NOR IN PRODUCTS OR SYSTEMS WHERE FAILURE OR MALFUNCTION MAY RESULT IN PERSONAL INJURY, DEATH, OR SEVERE PROPERTY OR ENVIRONMENTAL DAMAGE. ST PRODUCTS WHICH ARE NOT SPECIFIED AS "AUTOMOTIVE GRADE" MAY ONLY BE USED IN AUTOMOTIVE APPLICATIONS AT USER'S OWN RISK.**

Resale of ST products with provisions different from the statements and/or technical features set forth in this document shall immediately void any warranty granted by ST for the ST product or service described herein and shall not create or extend in any manner whatsoever, any liability of ST.

ST and the ST logo are trademarks or registered trademarks of ST in various countries.

Information in this document supersedes and replaces all information previously supplied.

The ST logo is a registered trademark of STMicroelectronics. All other names are the property of their respective owners.

© 2012 STMicroelectronics - All rights reserved

STMicroelectronics group of companies

Australia - Belgium - Brazil - Canada - China - Czech Republic - Finland - France - Germany - Hong Kong - India - Israel - Italy - Japan - Malaysia - Malta - Morocco - Philippines - Singapore - Spain - Sweden - Switzerland - United Kingdom - United States of America

[www.st.com](http://www.st.com)

