



SANYO Semiconductors

DATA SHEET

CMOS LSI
LC7363/7363M — DTMF/PULSE Switchable Dialer

The LC7363,7363M are DTMF/OUTPUT-PULSE dialer CMOS LSIs with redial function for use in pushbutton telephones. The LC7363 is packaged in a 22-pin (shrink) DIP. The LC7363M is packaged in a 30-pin MFP.

Features

- (1) Low voltage CMOS process for direct operation from telephone line.
- (2) Possible to use single contact or standard 2-of-7, 2-of-8 key pad.
- (3) Possible to use color-burst crystal resonator for on-chip oscillator ($f_{OSC}=3.58MHz$)
- (4) Possible to use either mode select pin (P/T) or function key (4 x 4 matrix key) to select DTMF mode/OUTPUT-PULSE mode.
- (5) Delivers 12 DTMF signals when in DTMF mode.
- (6) On-chip 31-digit redial memory.
- (7) Possible to provide mix redial (31 digits-PAUSE-MC) of DTMF/OUTPUT-PULSE modes.
- (8) Either auto pause select (4sec. x n) or manual release available for mode select standby time during redial operation.
- (9) Output pulse make rate of OUTPUT-PULSE mode: Pin-selectable (33.2% or 40%)
- (10) Output pulse rate of OUTPUT-PULSE mode: Pin-selectable (10pps or 20pps)
- (11) On-chip circuit to prevent malfunction due to noise pulse caused by key entry.
- (12) Key touch tone (pacifier tone) output capability
 OUTPUT-PULSE mode: 621.5Hz/50ms
- (13) Supply voltage/operating temperature
 DTMF mode: $V_{DD}=2.0$ to 6V/ $T_a=-30$ to $+70^{\circ}C$
 OUTPUT-PULSE mode: $V_{DD}=1.5$ to 6V/ $T_a=-30$ to $+70^{\circ}C$
- (14) Operating current
 DTMF mode: $I_{DD}=1.0mA_{max}/V_{DD}=3.5V$
 OUTPUT-PULSE mode: $I_{DD}=500\mu A_{max}/V_{DD}=3.5V$
- (15) Data retention current
 $I_{DR} \leq 0.5\mu A/V_{DD}=1.0V$

LC7363
 Case Outline 3059-D22SIC
 (unit:mm)

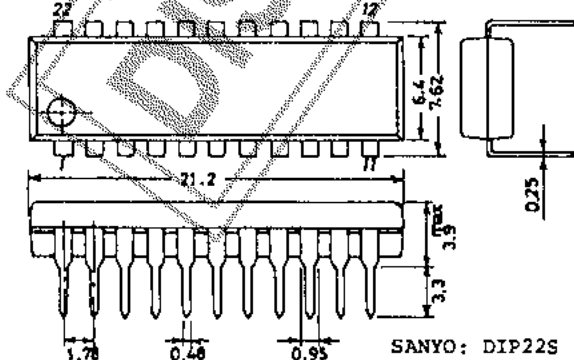

LC7363M
 Case Outline 3073A-M30IC
 (unit:mm)

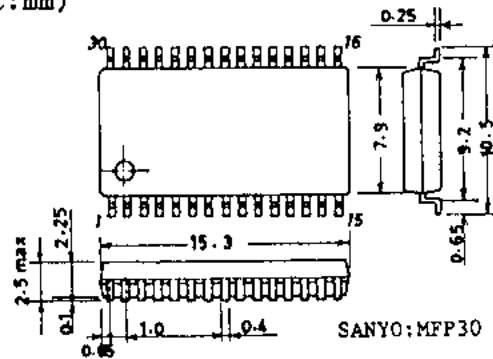

Specifications and information herein are subject to change without notice.

SANYO Electric Co.,Ltd. Semiconductor Company

TOKYO OFFICE Tokyo Bldg., 1-10, 1 Chome, Ueno, Taito-ku, TOKYO, 110-8534 JAPAN

LC7363,7363M

Pin Assignment (top view)

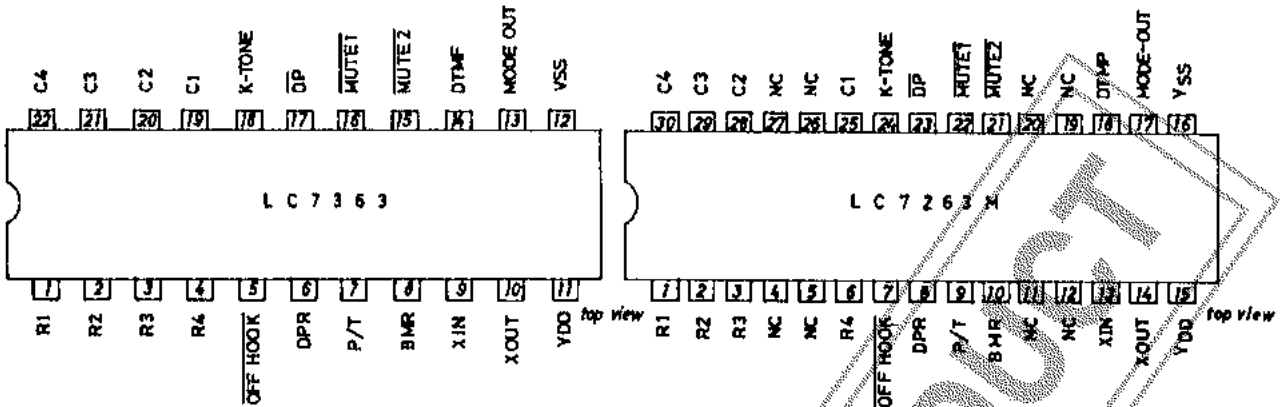

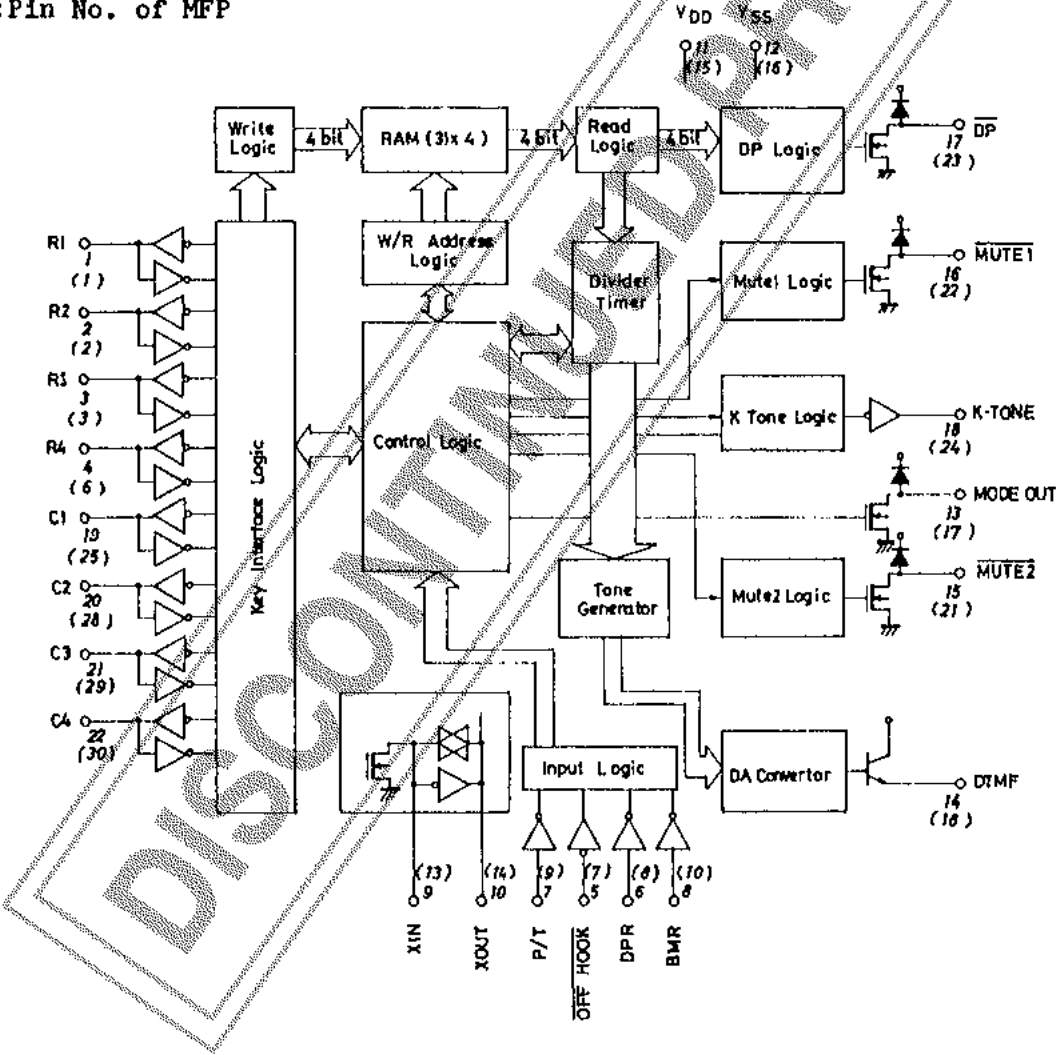

Equivalent Circuit Block Diagram

(): Pin No. of MFP

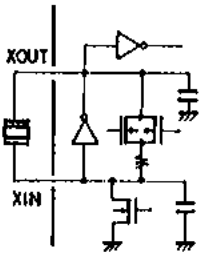
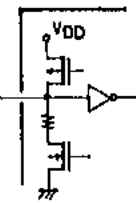
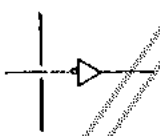

Pin Description (): Pin No. of MFP

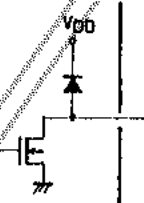
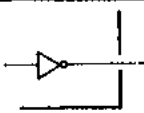
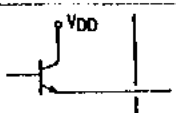
Pin Name	Pin No.	I/O Configuration	Function
VDD	11(15)		Power supply pin.
VSS	12(16)		
XIN	9 (13)		Used to generate the reference frequency. Uses a crystal resonator of 3.579545MHz. With the feedback resistor and capacitors contained to form the OSC circuit, a crystal resonator is simply connected across the pins. When using a ceramic resonator, a capacitor of approximately 30pF must be connected to each pin.
XOUT	10 (14)		
R1toR4 C1toC4	1to4 22to19 (1to3 6 25 28to30)		Row and column input pin. High-active input. Contains a P-channel transistor for keyboard scan and an N-channel transistor for pull-down. When in the ON-HOOK state, the P-channel transistor is turned OFF and the N-channel transistor is turned ON.
OFF-HOOK	5 (7)		HOOK SW input. "H" level=ON-HOOK "L" level=OFF-HOOK
DPR	6 (8)		Dial pulse rate select input. "H" level=20pps "L" level=10pps
P/T	7 (9)		Pulse/tone select input. "H" level=Pulse mode "L" level=DTMF mode
BMR	8 (10)		Make rate select input. "H" level=33.2% "L" level=40%
DP	17(23)		Dial pulse output.
MUTE1	16 (22)		Mute output. Operates at the OUTPUT-PULSE mode. Capable of being wired-ORed with MUTE2.
MUTE2	15 (21)		Mute output. Operates at the DTMF mode. Capable of being wired-ORed with MUTE1.
MODE-OUT	13 (17)		DTMF/OUTPUT-PULSE mode output. OUTPUT-PULSE mode="L" level DTMF mode="H" impedance
K-TONE	18 (24)		When a key is pushed at the OUTPUT-PULSE mode, the K-TONE (pacifier tone) of 621.5Hz/50ms is outputted.
DTMF	14 (18)		The DTMF signal is outputted. NPN transistor-used emitter follower

Key Assignment

1	2	3	F	R1
4	5	6	P	R2
7	8	9	RD	R3
×	0	#	MC	R4
C1	C2	C3	C4	

- F** : Flash
- P** : Pause
- RD** : Redial, pause release
- MC** : Pulse=tone select

When in OUTPUT-PULSE mode

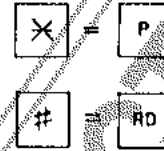

Absolute Maximum Ratings at Ta=25±2°C

		unit
Maximum Supply Voltage	V _{DD}	-0.3 to +7 V
Maximum Input Voltage	V _{IN}	-0.3 to V _{DD} +0.3 V
Maximum Output Voltage	V _{OUT}	-0.3 to V _{DD} +0.3 V
Allowable Power Dissipation	P _{d,max} Ta=70°C	300 mW
Minimum Load Resistance	R _{L,min} Across DTMF and V _{SS} pin	100 ohm
Operating Temperature	T _{opg}	-30 to +70 °C
Storage Temperature	T _{stg}	-40 to +125 °C

Allowable Operating Conditions at Ta=-30 to +70°C, V_{DD}=1.5 to 6V

		min	typ	max	unit
Supply Voltage	V _{DDP} OUTPUT-PULSE mode	1.5		6.0	V
	V _{DDT} DTMF mode	2.0		6.0	V
"H"-Level Input Voltage	V _{IH} All input pins	0.7V _{DD}		V _{DD}	V
"L"-Level Input Voltage	V _{IL} All input pins	V _{SS}	0.3V _{DD}		V
Key Contact Resistance	R _{KI}			3.0	kohm
Keyboard Capacitance	C _{KI}			330	pF
Resonator Spec.	f _s			3.579545MHz±0.7%	
	R _s			<100ohms	

Electrical Characteristics at Ta=25±2°C, V_{DD}=1.5 to 6.0V

		min	typ	max	unit
Operating Current	I _{DDP} OUTPUT-PULSE mode, output open, V _{DD} =3.5V	0.3	0.5		mA
	I _{DDT} DTMF mode, output open, V _{DD} =3.5V	0.5	1.0		mA
Quiescent Current	I _{DD(ST)} OFF-HOOK pin=V _{DD} , V _{DD} =1.5 to 6.0V, output open			1	uA
Data Retention Voltage	V _{DR}			1	V
Data Retention Current	I _{DR} V _{DD} =1V			0.5	uA
"H"-Level Input Current	I _{IH} (OFF-HOOK, DPR, P/T, BMR) pin, V _{IH} =V _{DD}			1	uA
"L"-Level Input Current	I _{IL} (OFF-HOOK, DPR, P/T, BMR) pin, -1 V _{IL} =V _{SS}				uA
Key Pin Current	I _{IHK} V _{DD} =1.5V, V _{IH} =V _{DD}			20	uA
	I _{OHK} V _{DD} =6V, V _{IH} =V _{DD}			300	uA
	I _{OHK} V _{DD} =1.5V, V _{OH} =0.8V _{DD}			-50	uA
	I _{OHK} V _{DD} =6V, V _{OH} =0.8V _{DD}			-700	uA
Output OFF-State Leakage Current	I _{OFF} V _O =V _{DD} , V _{DD} =6V, output OFF, (DP, MUTE1, MUTE2, MODE-OUT)			1	uA

Continued on next page.

Continued from preceding page.

			min	typ	max	unit
Output Pin Voltage	V_{OH}	K-TONE pin: $V_{DD}=1.5V$, $V_{DD}-0.5$ $I_{OH}=-40\mu A$				V
		K-TONE pin: $V_{DD}=3.5V$, $V_{DD}-1$ $I_{OH}=-200\mu A$				V
	V_{OL}	(K-TONE, DP MUTE1, MUTE2 MODE-OUT) pin	$V_{DD}=1.5V, I_{OL}=40\mu A$		0.4	V
			$V_{DD}=3.5V, I_{OL}=200\mu A$		0.4	V

AC Characteristics at $T_a=25\pm 2^\circ C, V_{DD}=1.5$ to $6V, f_{osc}=3.579545MHz$

			min	typ	max	unit
Key Debounce Time	T_{KD}		10.8		11.6	ms
K-TONE Frequency	f_{KT}			621.5		Hz
K-TONE Output Time	T_{KT}			50.9		ms
Auto Pause Time	T_{AP}			3.99		s
Single Tone Output	V_{OR}	ROW TONE output, $V_{DD}=3.5V$, $R_L=10k\Omega$	170	205	245	mVrms
Tone Output Ratio	dB_{CR}	$V_{DD}=2.0$ to $6V, R_L=10k\Omega$	1	2	3	dB
Tone Output Distortion	$\%DIS$	$V_{DD}=2.5$ to $6V, R_L=10k\Omega$, $f=300$ to $3400Hz$			7	%
		$V_{DD}=2$ to $6V, R_L=10k\Omega$, $f=300$ to $3400Hz$			10	%
Oscillation Start Time	T_{START}	$V_{DD}=1.7$ to $6V$ $V_{DD}=3.5V$			20	ms
					8	ms
DTMF Output Time	T_{MFON}			97.6		ms
DTMF Interdigit Pause	T_{MFOFF}			100.6		ms

. Dial pulse output

$f_{osc}=3.579545MHz$

Pin DPR	Pin BMR	Dial pulse rate	Interdigit pause	Make ratio
VSS	VDD	9.94 PPS	838.1 ms	33.2 %
VDD	VDD	19.89 PPS	519.6 ms	33.2 %
VSS	VSS	9.94 PPS	844.8 ms	40 %
VDD	VSS	19.89 PPS	523.0 ms	40 %

. DTMF output

$f_{osc}=3.579545MHz$

Input	Output frequency (Hz)		Deviation (%)
	Standard	LC7363	
R1	697	699.1	+0.30
R2	770	766.2	-0.49
R3	852	847.4	-0.54
R4	941	948.0	+0.74
C1	1209	1215.9	+0.57
C2	1336	1331.7	-0.32
C3	1477	1471.9	-0.35

. Redial operation

$f_{osc}=3.579545MHz$

Parameter	Time	
	1st digit	2nd digit onward
DTMF output	97.6ms	100.6ms
Interdigit pause	100.6ms	100.6ms
Period	198.2ms	201.2ms

Timing Chart

(1) OUTPUT-PULSE mode

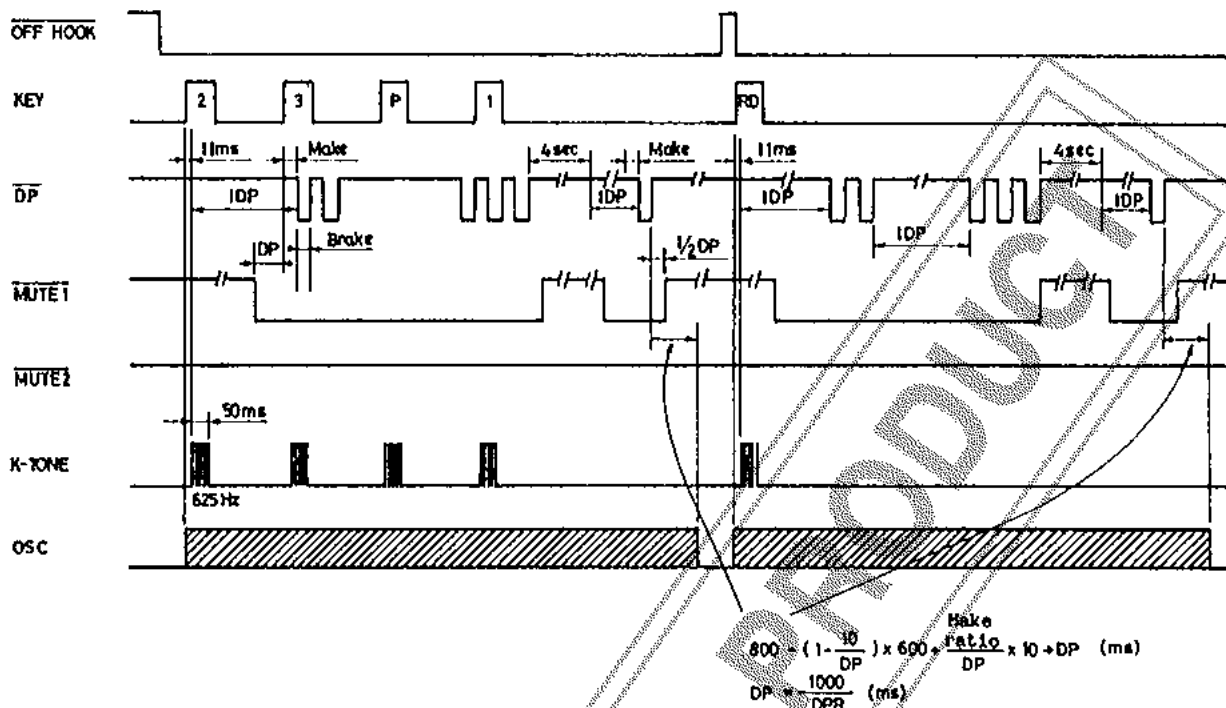

(2) Tone mode

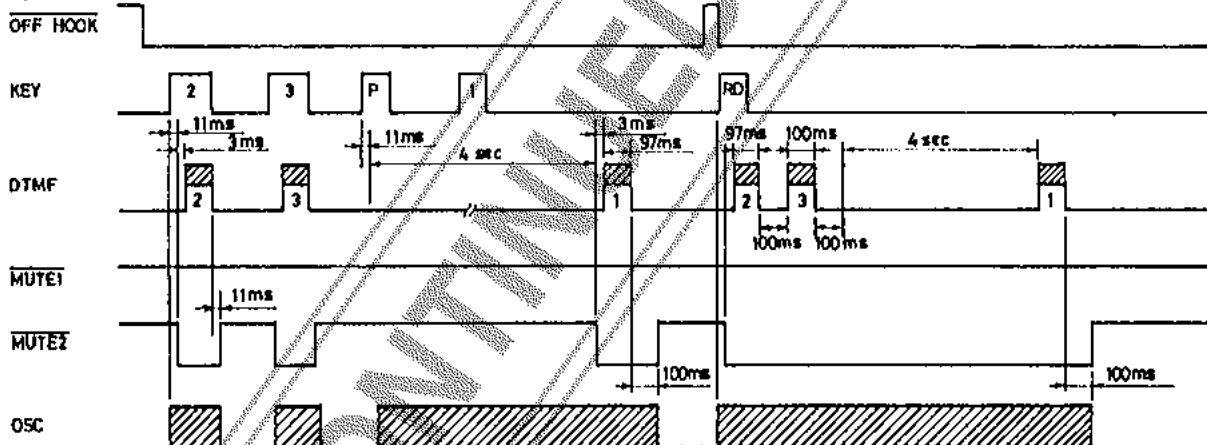

(3) Pulse → tone mix (P/T='H')

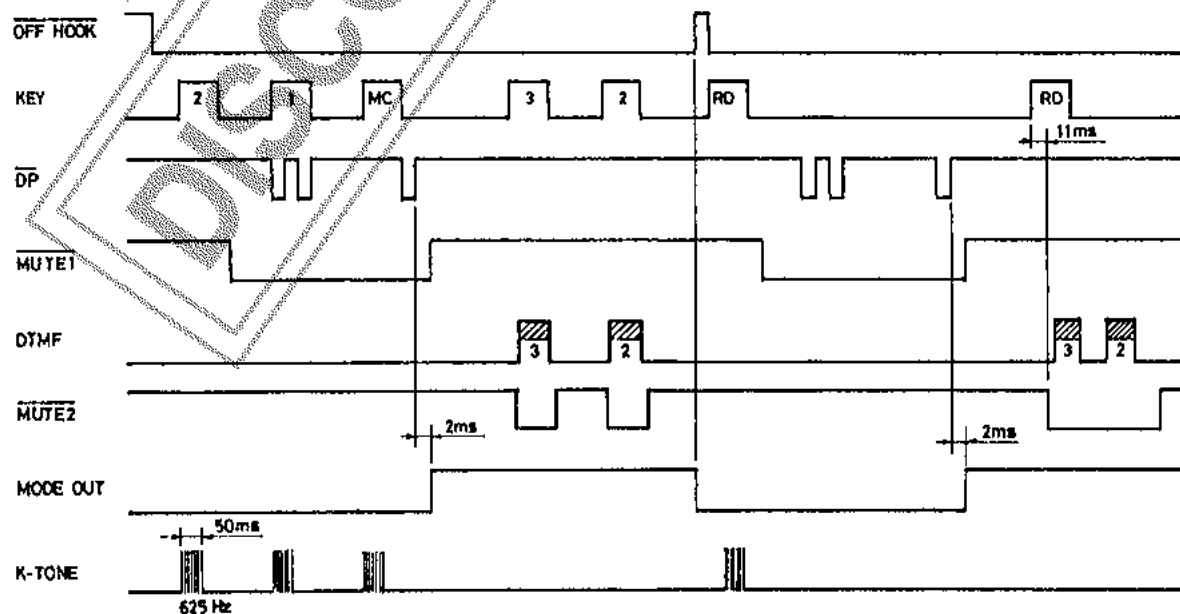

(4) Tone → pulse mix

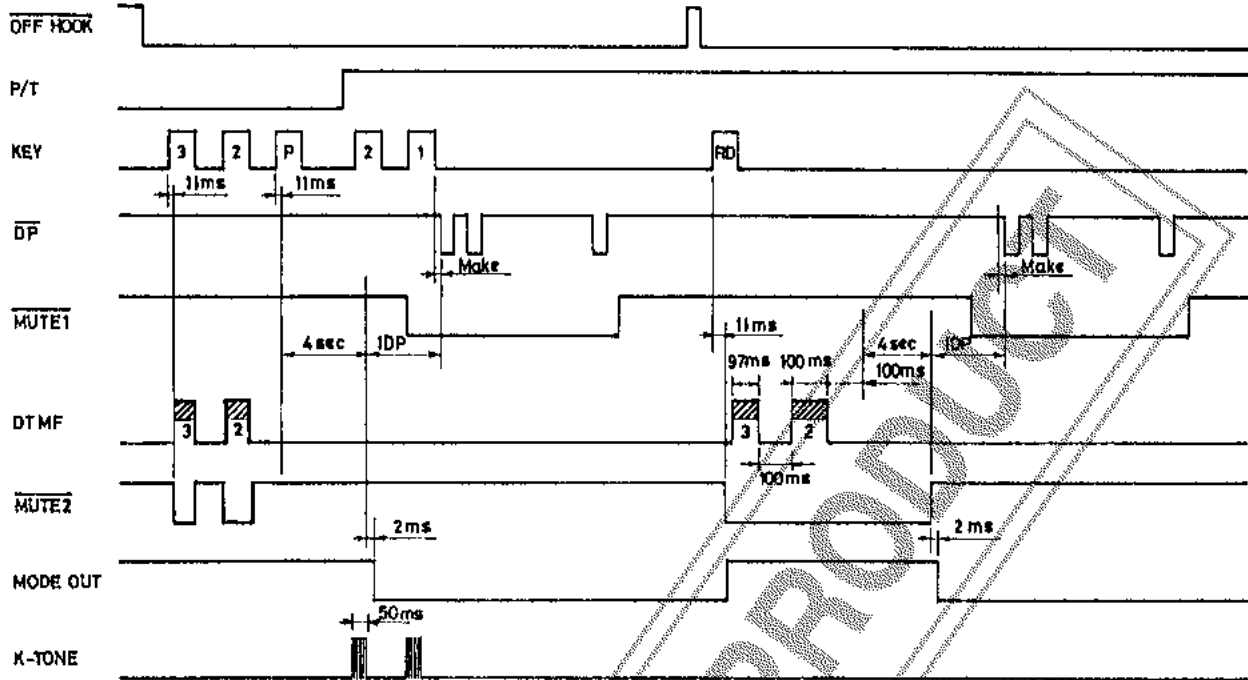

(5) Timing of flash

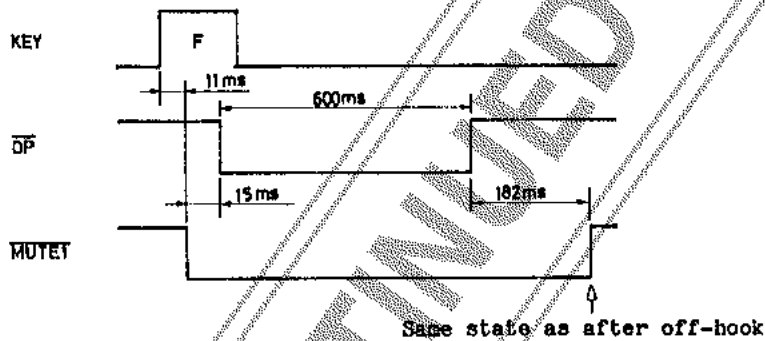

(6) Mix dial and redial (key entry available after redial) by P/T input (Slide SW, etc.)

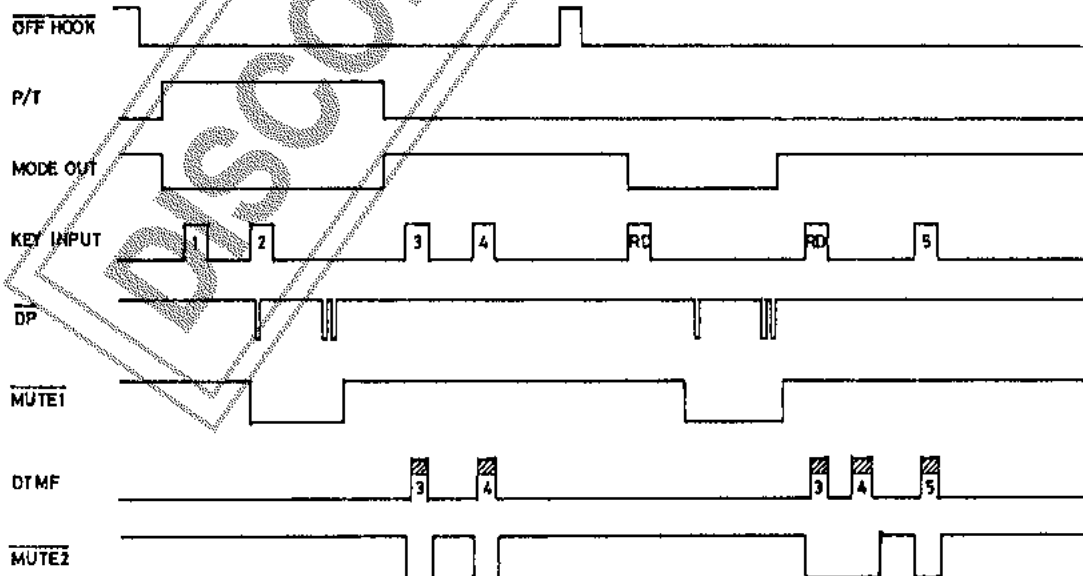

Continued on next page.

Continued from preceding page.

- . Even when the tone mode (P/T SW: "Tone") is entered at the OFF-HOOK state, the OUTPUT-PULSE mode can be entered (P/T SW: "Pulse").
- . The output mode provided when redialing is the one provided when dialed previously (regardless of the P/T SW position when the RD key is pushed)

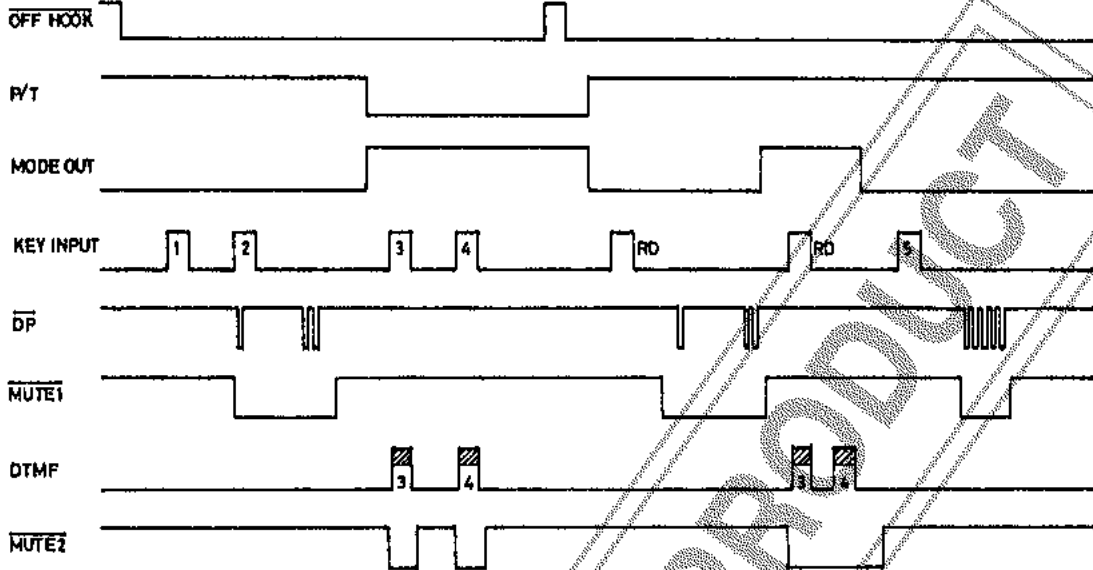

- . The mode after completion of redialing is set again by the P/T SW position provided when redialing is completed.

Since the \overline{DP} , $\overline{MUTE1}$, $\overline{MUTE2}$, $\overline{MODE-OUT}$ outputs are of the Nch open drain type, the output transistor OFF-state ("H" impedance) provides "H" level. Likewise, since the DTMF output is of the emitter follower type, the output transistor OFF-state ("H" impedance) provides "L" level.

Key operation

(1) Normal dial



Redial



(2) PBX dial



Redial



(3) Pulse/tone mix

① In case where there is no pause during mode select

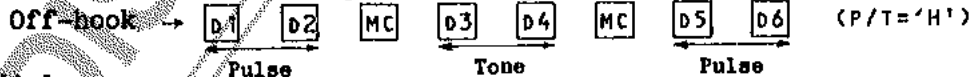

Redial

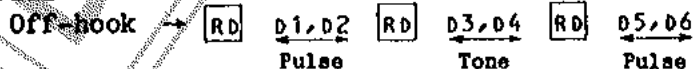

② In case where there are pauses during mode select

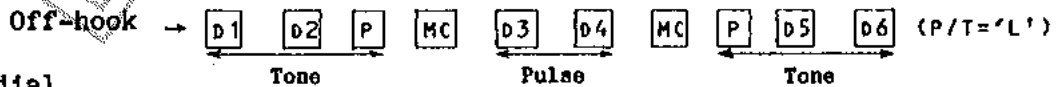

Redial

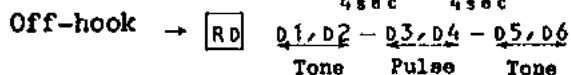

- (Note) (a) When in OUTPUT-PULSE mode $P = \times$ $RD = \#$
 (b) Pause: 4 sec./1 push of P , 8 sec./2 pushes of P ,
 4 x n sec./n pushes of P
 (c) For pause release, push RD . All pauses can be also released by pushing RD once.

Sample Application Circuit (Tentative)
 Pin Nos. are for DIP.

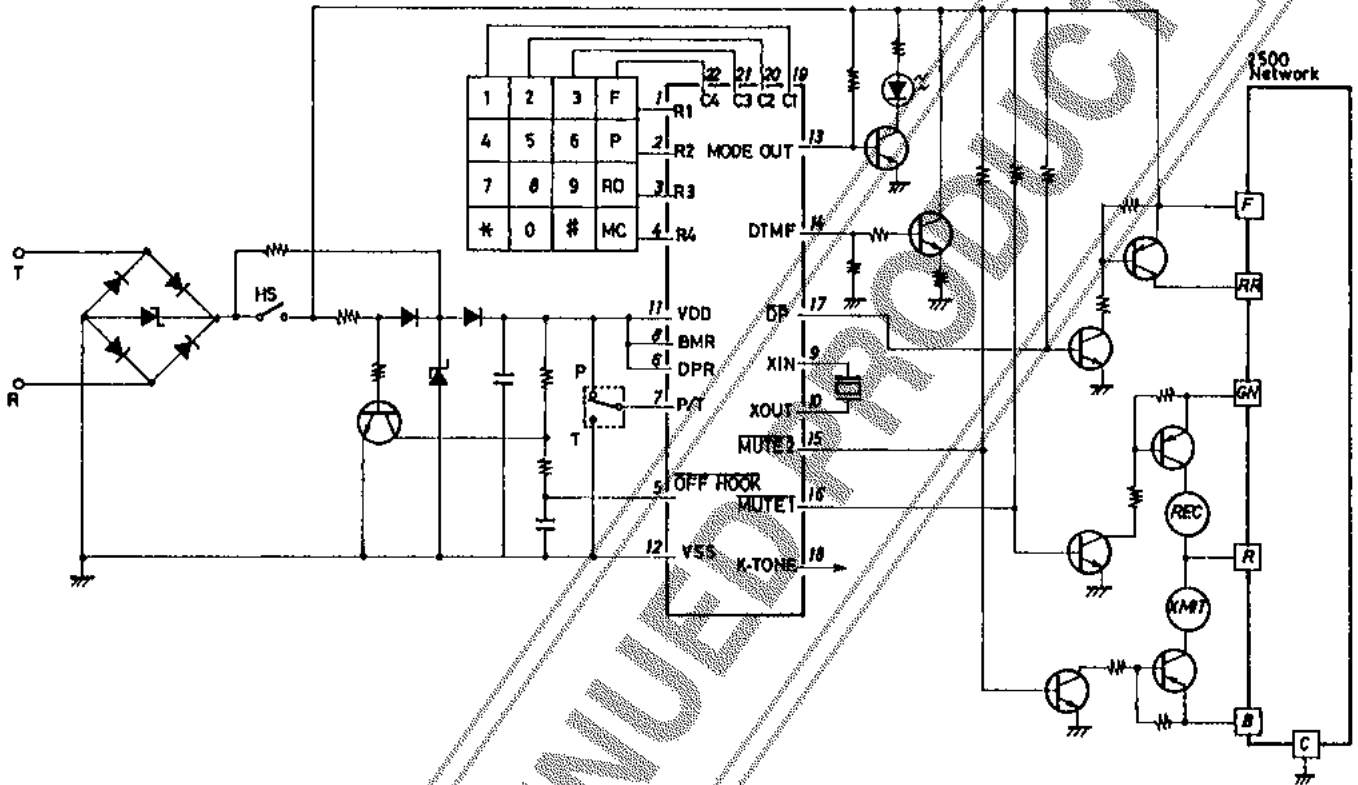

The application circuit diagrams and circuit constants herein are included as an example and provide no guarantee for designing equipment to be mass produced. The information herein is believed to be accurate and reliable. However, no responsibility is assumed by SANYO for its use, nor for any infringements of patents or other rights of third parties which may result from its use.