

# 2SC5241

## 5A NPN

### OUTLINE DIMENSIONS

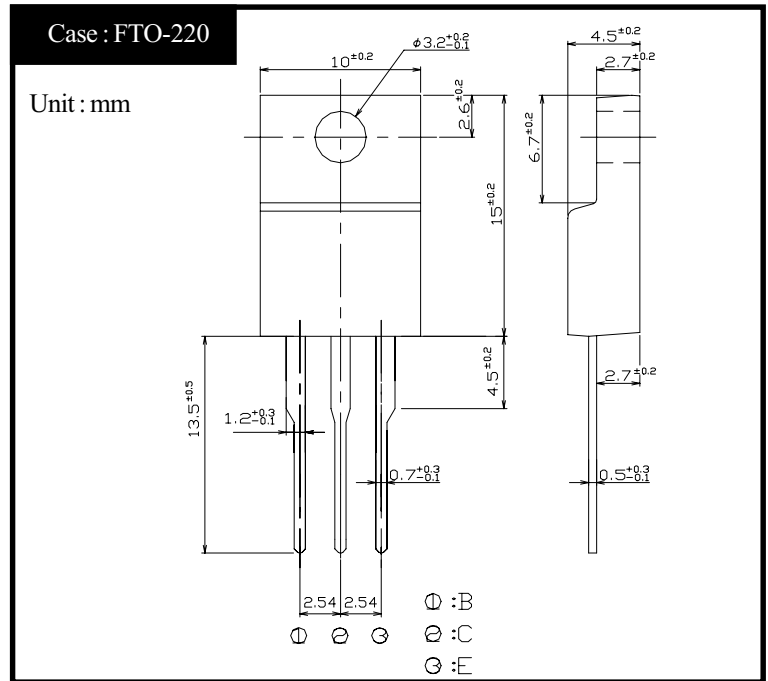

### RATINGS

#### ● Absolute Maximum Ratings

Item	Symbol	Conditions	Ratings	Unit
Storage Temperature	$T_{stg}$		-55~150	°C
Junction Temperature	$T_j$		150	°C
Collector to Base Voltage	$V_{CBO}$		600	V
Collector to Emitter Voltage	$V_{CEO}$		450	V
	$V_{CEX}$	$V_{EB} = 5V$	600	
Emitter to Base Voltage	$V_{EBO}$		7	V
Collector Current DC	$I_C$		5	A
Collector Current Peak	$I_{CP}$		10	
Base Current DC	$I_B$		2	A
Base Current Peak	$I_{BP}$		4	
Total Transistor Dissipation	$P_T$		30	W
Dielectric Strength	$V_{dis}$	Terminals to case, AC 1 minute	2	kV
Mounting Torque	TOR	(Recommended torque)	0.5(0.3)	N·m

#### ● Electrical Characteristics ( $T_c=25^\circ\text{C}$ )

Item	Symbol	Conditions	Ratings	Unit
Collector to Emitter Sustaining Voltage	$V_{CEO}(\text{sus})$	$I_C = 0.1A$	Min 450	V
Collector Cutoff Current	$I_{CBO}$	rated $V_{CBO}$	Max 0.1	mA
	$I_{CEO}$	rated $V_{CEO}$	Max 0.1	
Emitter Cutoff Current	$I_{EBO}$	rated $V_{EBO}$	Max 0.1	mA
DC Current Gain	$h_{FE}$	$V_{CE} = 5V, I_C = 2.5A$	Min 10	
	$h_{FEL}$	$V_{CE} = 5V, I_C = 1mA$	Min 5	
Collector to Emitter Saturation Voltage	$V_{CE}(\text{sat})$	$I_C = 2.5A$	Max 1.0	V
Base to Emitter Saturation Voltage	$V_{BE}(\text{sat})$	$I_B = 0.5A$	Max 1.5	V
Thermal Resistance	$\theta_{jc}$	Junction to case	Max 4.16	°C/W
Transition Frequency	$f_T$	$V_{CE} = 10V, I_C = 0.5A$	STD 20	MHz
Turn on Time	$t_{on}$	$I_C = 2.5A$	Max 0.5	$\mu s$
Storage Time	$t_s$	$I_{B1} = 0.5A, I_{B2} = 1A$	Max 2.0	
Fall Time	$t_f$	$R_L = 60\Omega, V_{BB2} = 4V$	Max 0.2	

# 2SC5241

$h_{FE} - I_C$

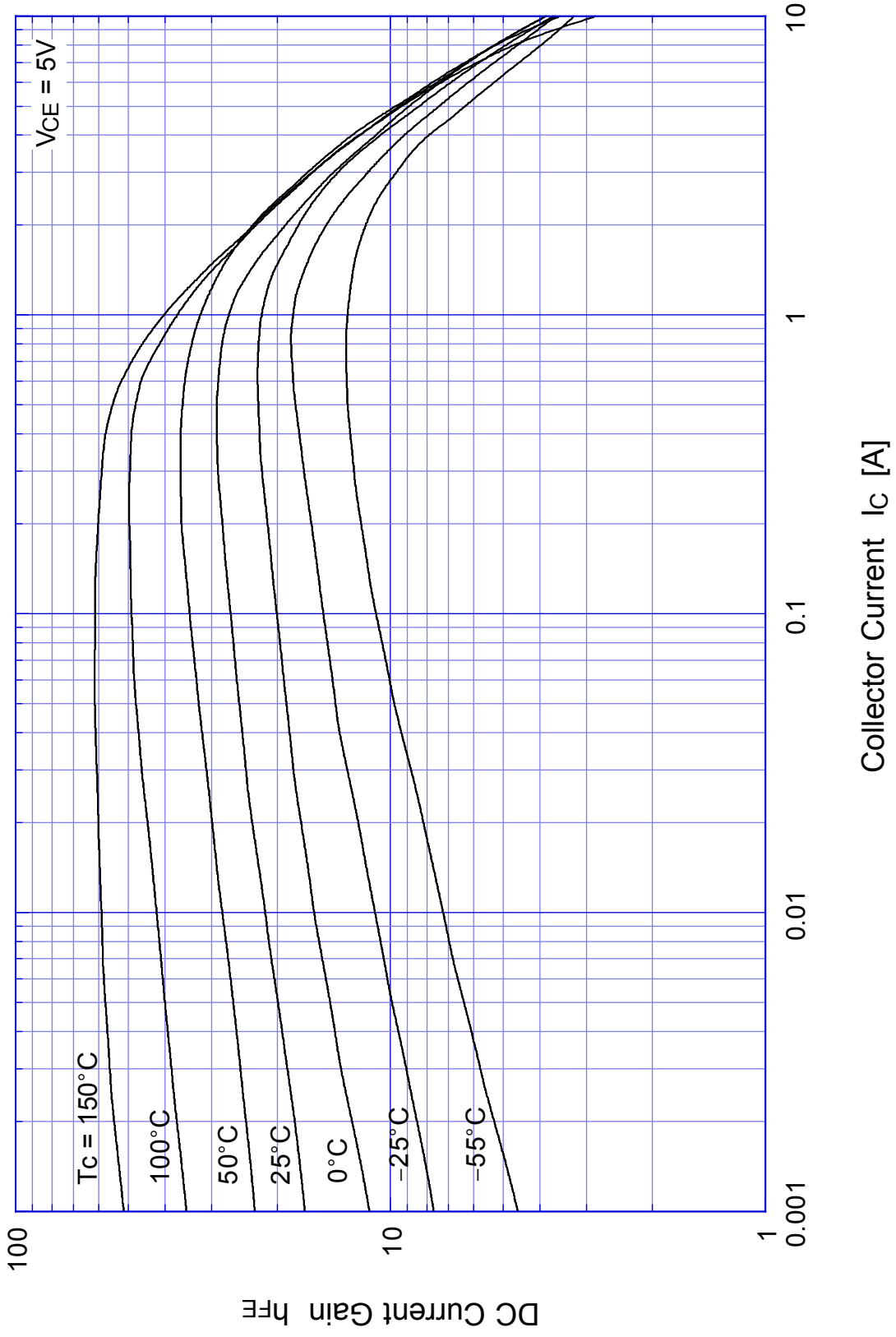

# 2SC5241 Saturation Voltage

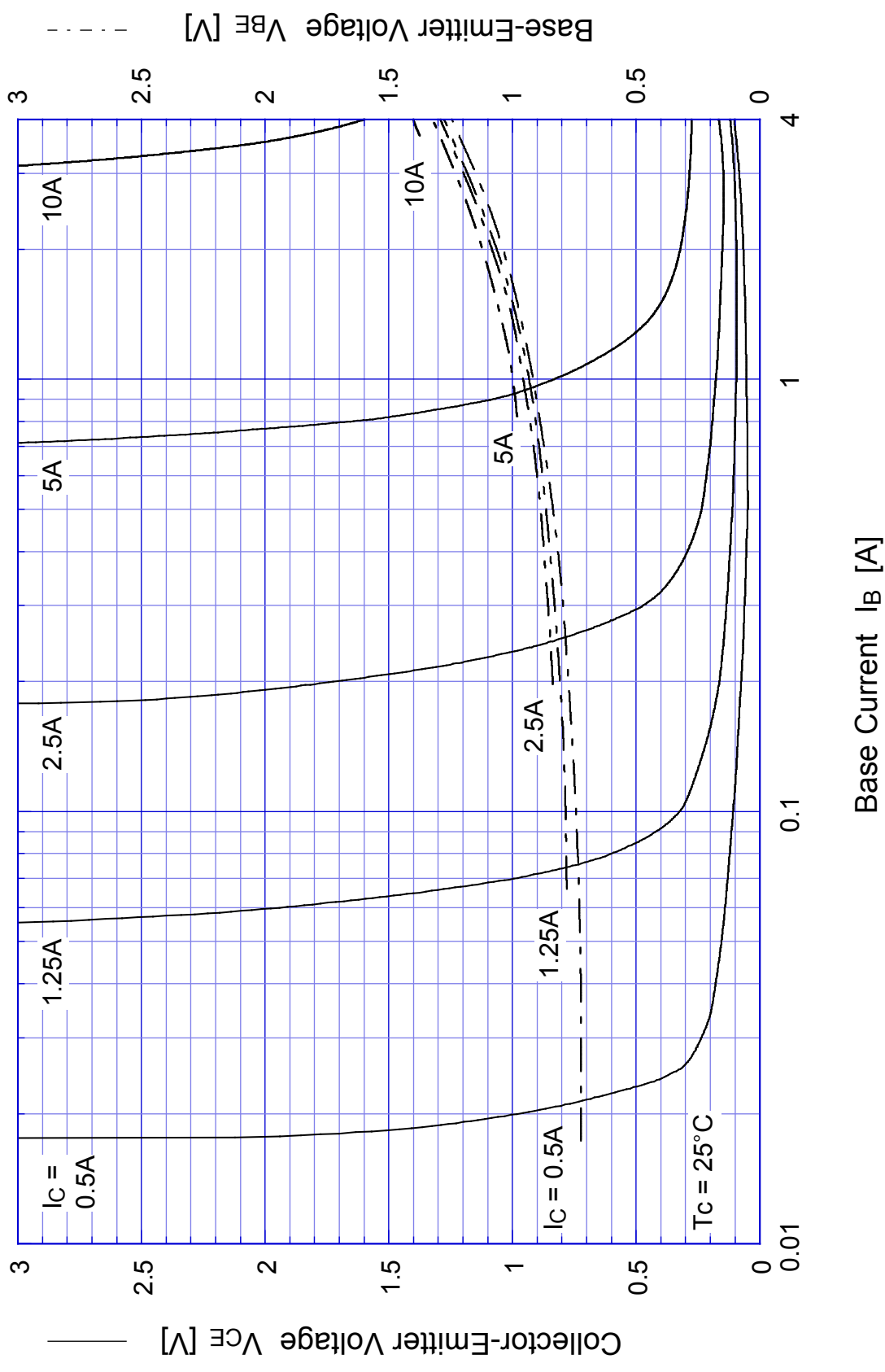

# 2SC5241

## Switching Time - $I_C$

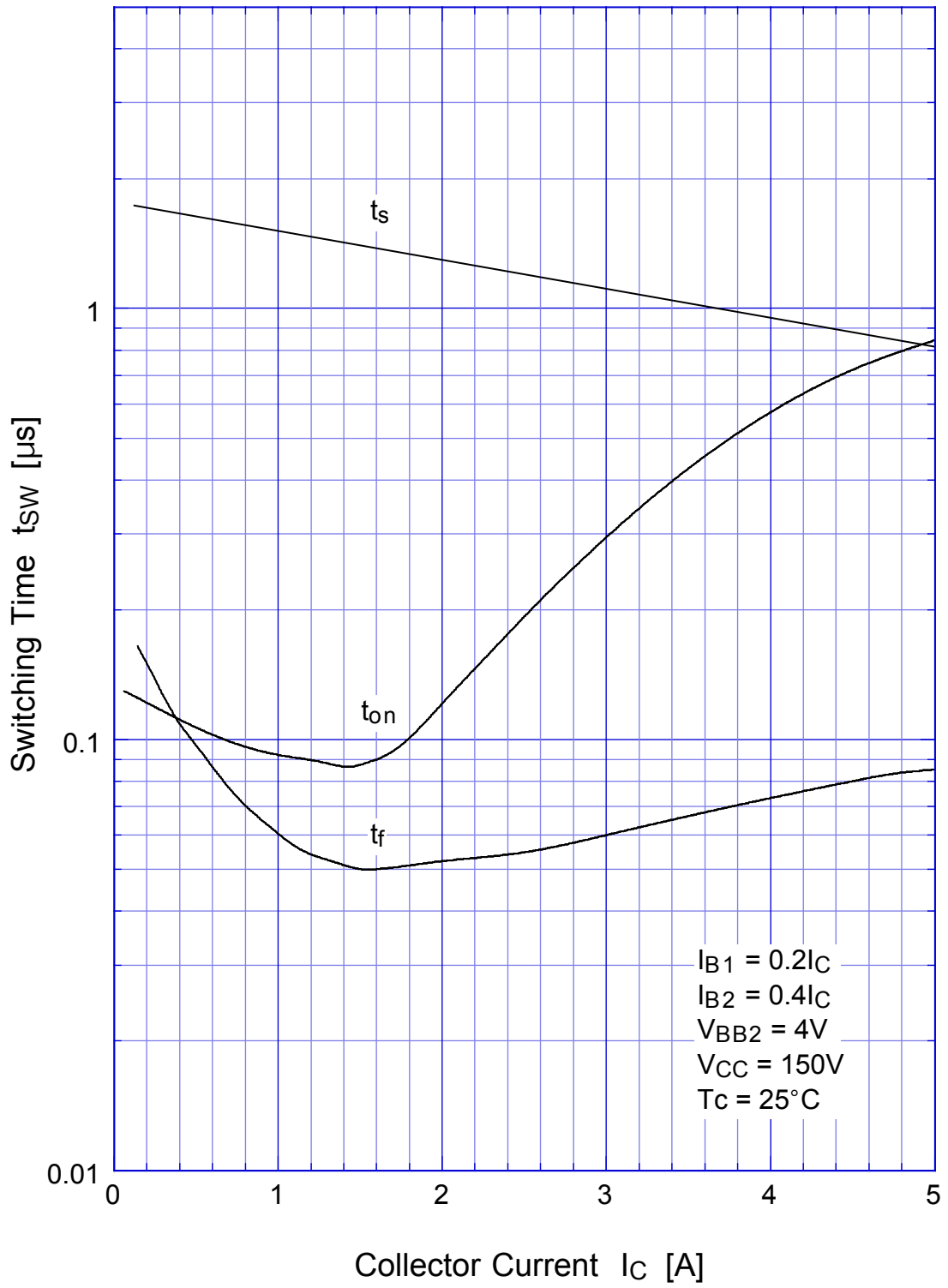

# 2SC5241 Switching Time - $V_{CC}$

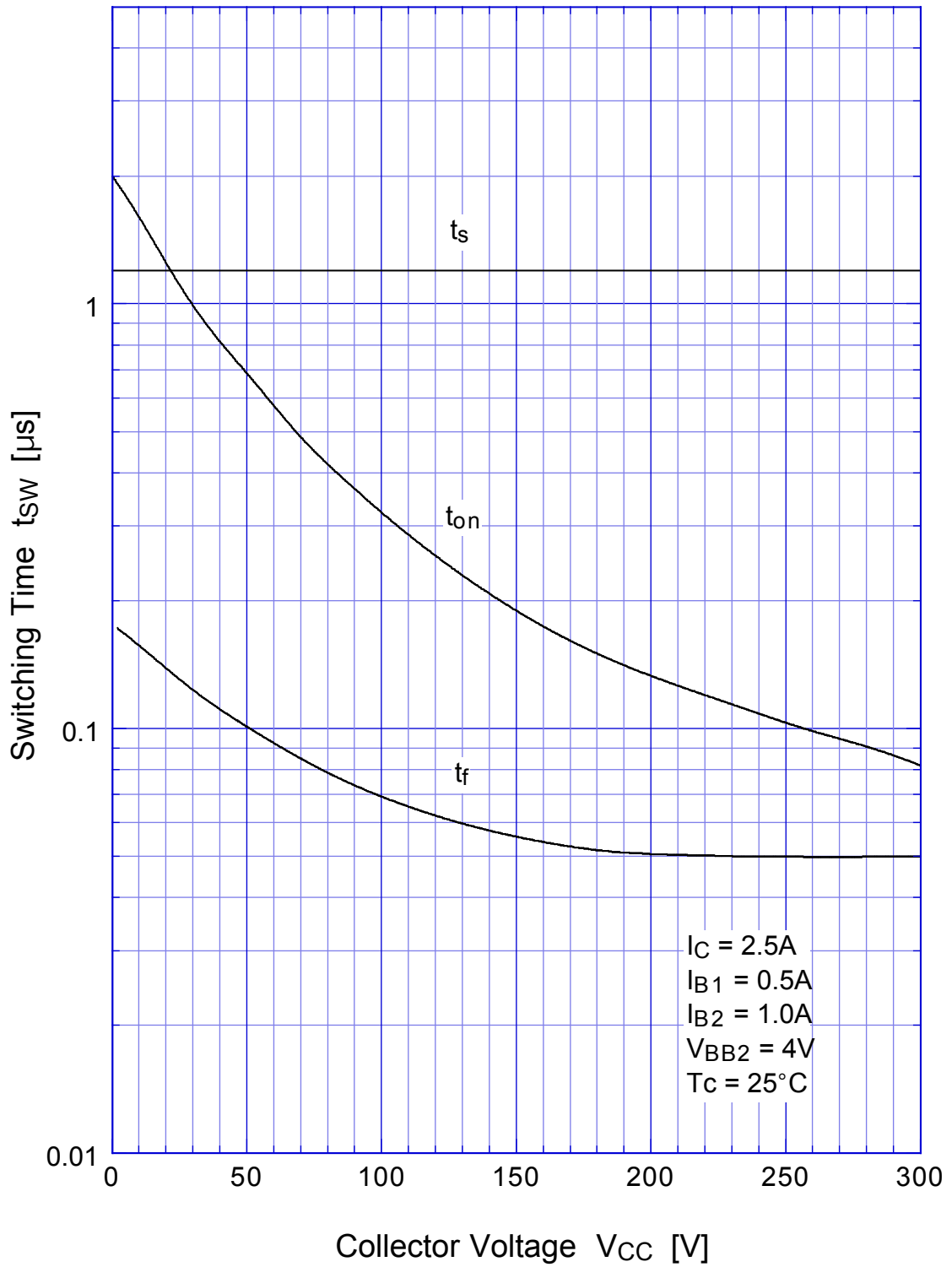

# 2SC5241

## Switching Time - Tc

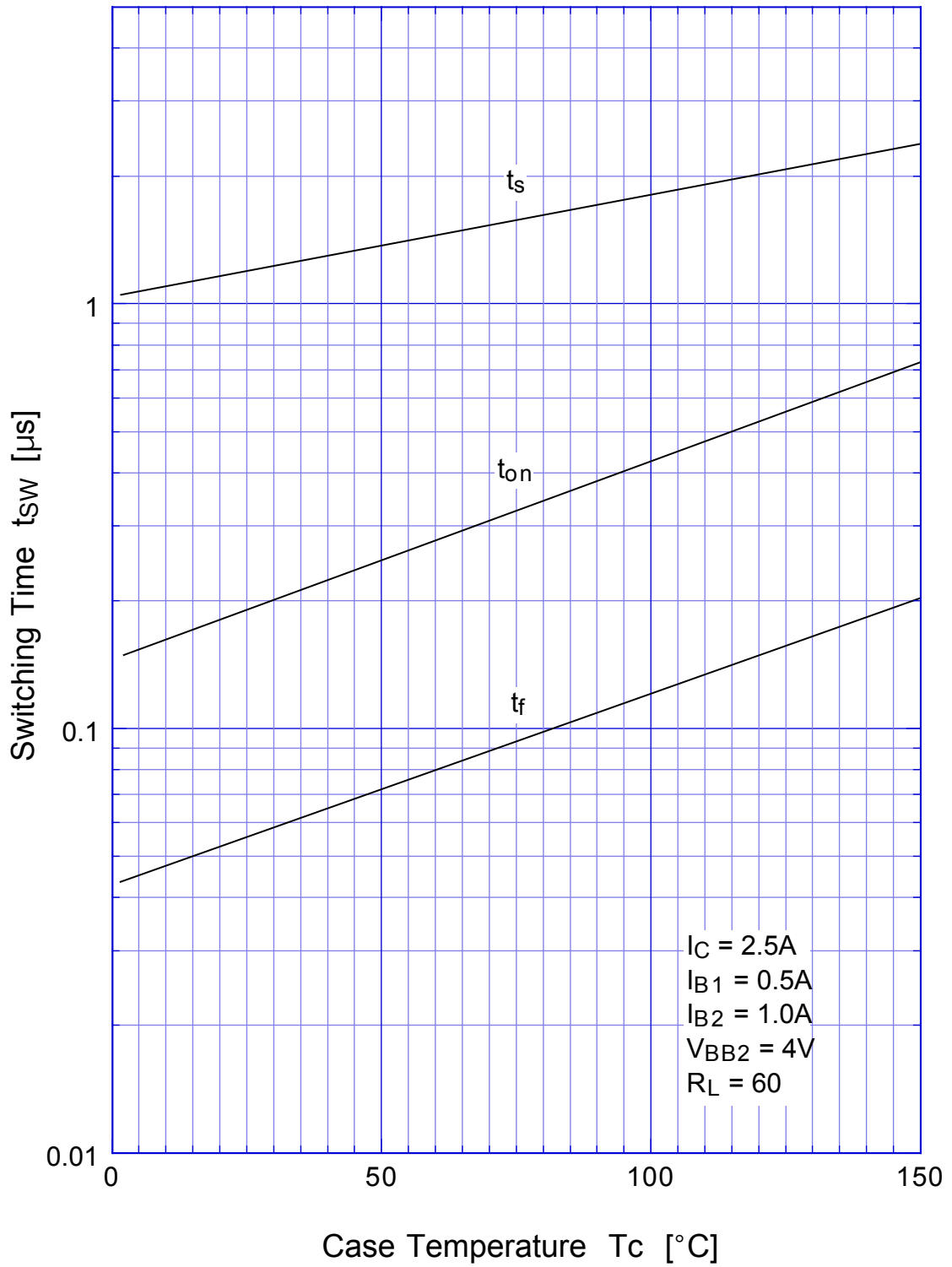

## 2SC5241 L-Load Switching Time - $I_C$

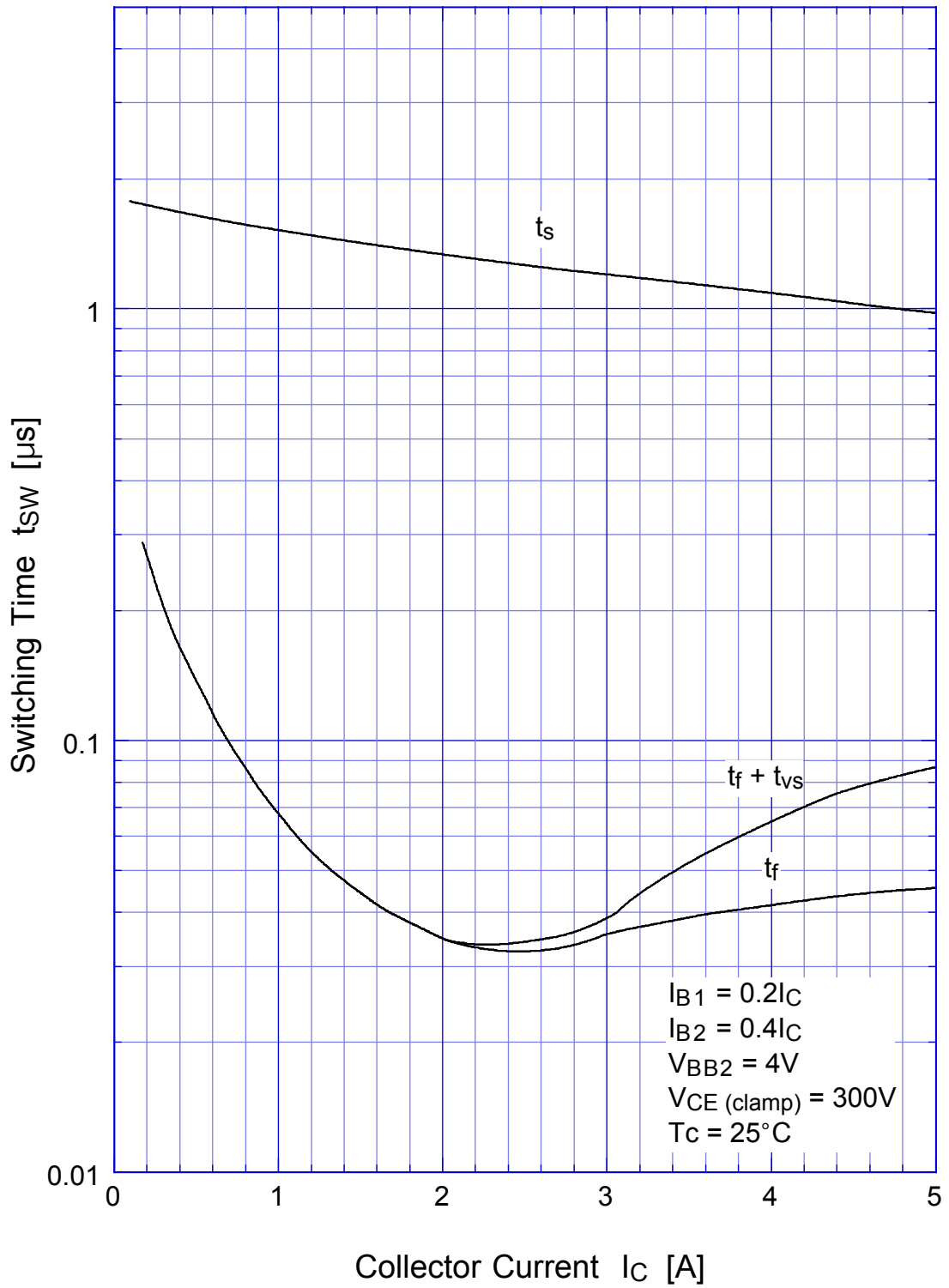

## 2SC5241 L-Load Switching Time - $I_C$ (At High Temperature)

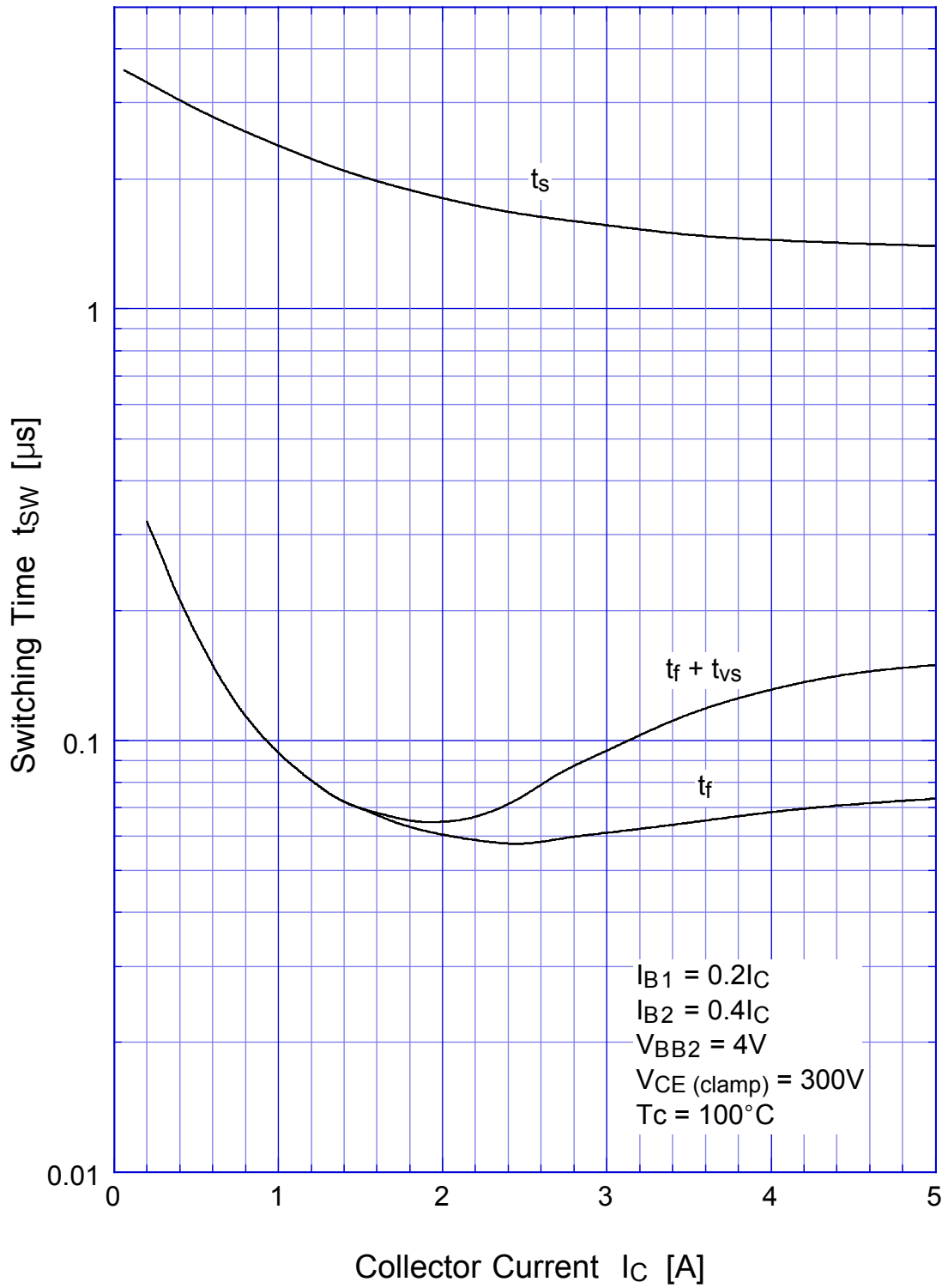



## 2SC5241 Transient Thermal Impedance

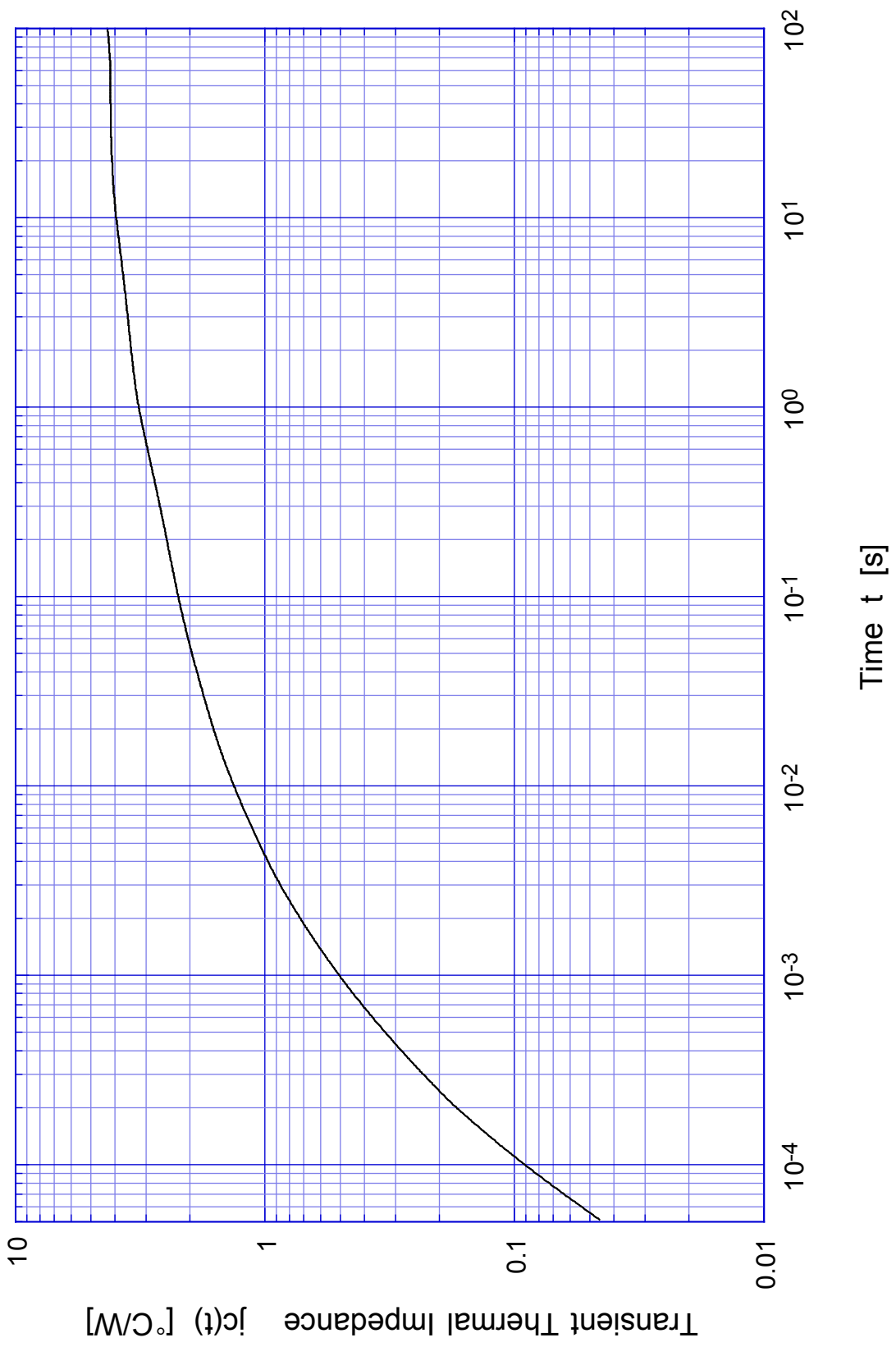

# 2SC5241

# Forward Bias SOA

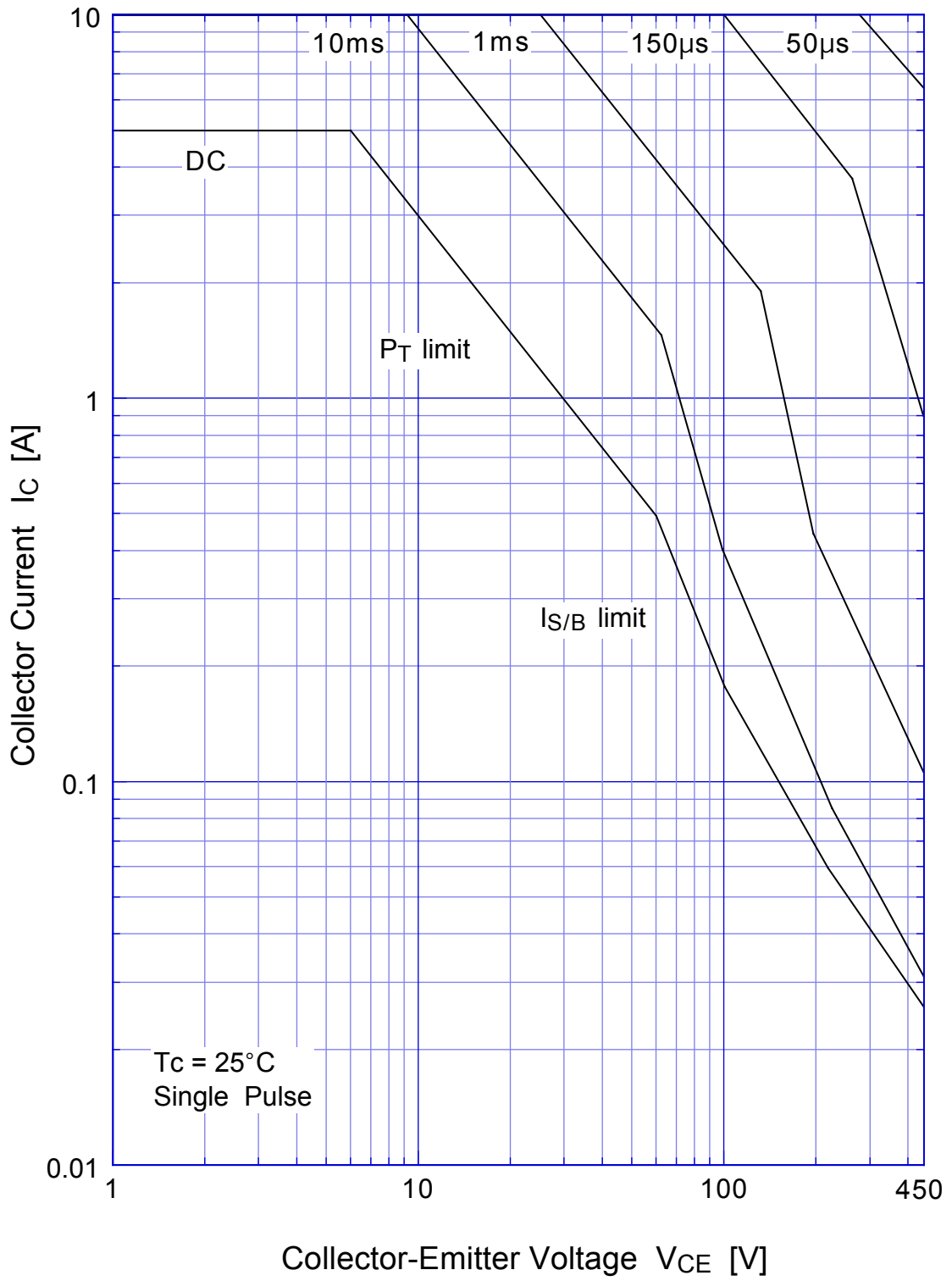

## 2SC5241 Collector Current Derating

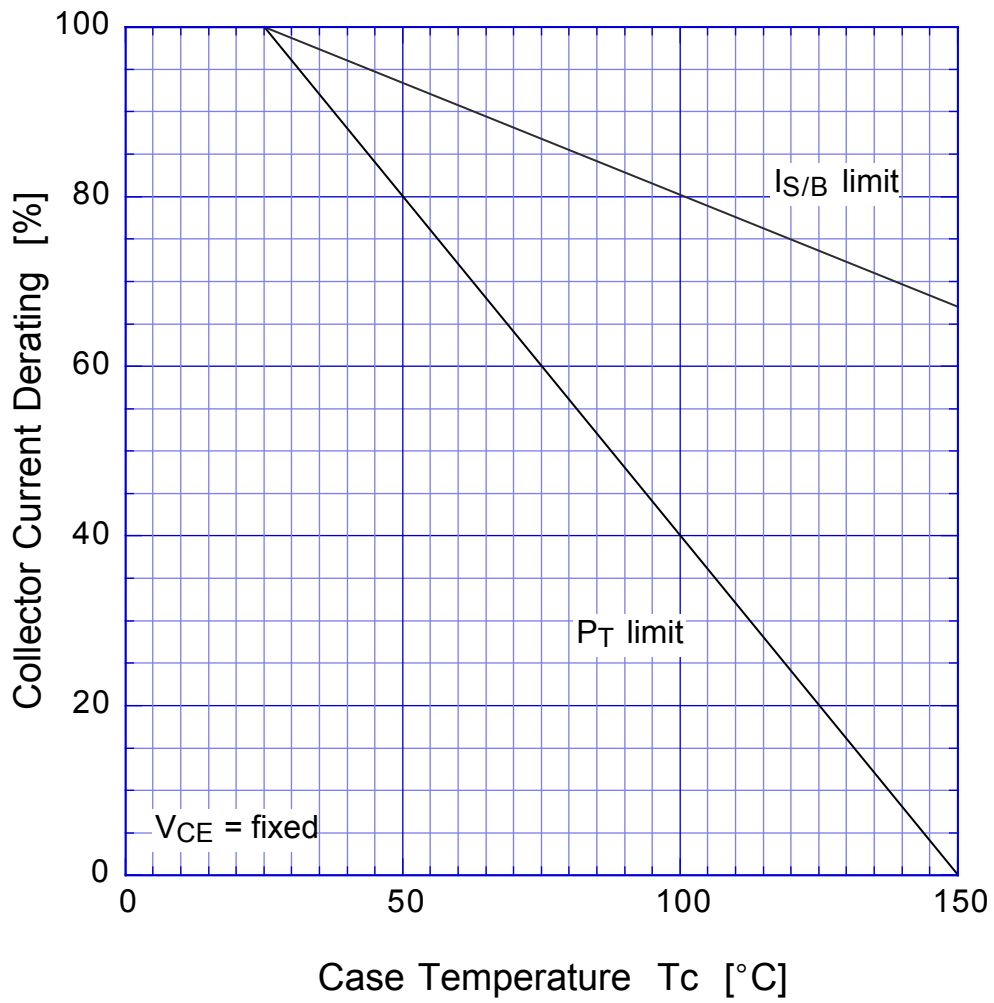

2SC5241

Reverse Bias SOA

