

N-CHANNEL MOS FIELD EFFECT POWER TRANSISTOR

Phase-out/Discontinued

2SK1198

DESCRIPTION The 2SK1198 is N-channel MOS Field Effect Power Transistor designed for switching power supplies, AC Adapters.

- FEATURES**
- Suitable for switching power supplies, actuator controls, and pulse circuits.
 - Low $R_{DS(on)}$
 - No second breakdown
 - Isolated mold package

ABSOLUTE MAXIMUM RATINGS

Maximum Temperatures	
Storage Temperature	-55 to +150 °C
Channel Temperature	150 °C Maximum
Maximum Power Dissipation ($T_c = 25\text{ °C}$)	
Total Power Dissipation	35 W
Maximum Voltages and Currents ($T_a = 25\text{ °C}$)	
V_{DSS} Drain to Source Voltage	700 V
V_{GSS} Gate to Source Voltage	±20 V
$I_{D(DC)}$ Drain Current (DC)	±2 A
$I_{D(pulse)}$ Drain Current (pulse)*	±8.0 A

* $PW \leq 10\ \mu s$, Duty Cycle $\leq 1\%$

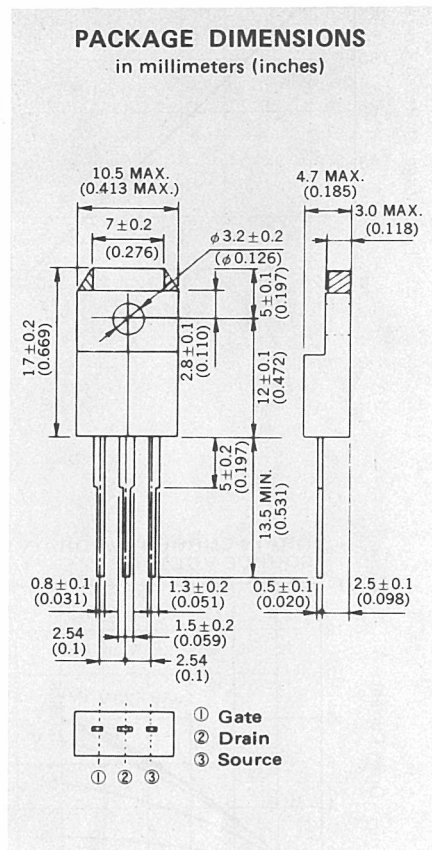

ELECTRICAL CHARACTERISTICS ($T_a = 25\text{ °C}$)

SYMBOL	CHARACTERISTIC	MIN.	TYP.	MAX.	UNIT	TEST CONDITIONS
I_{DSS}	Drain Leakage Current			100	μA	$V_{DS} = 700\text{ V}, V_{GS} = 0$
I_{GSS}	Gate to Source Leakage Current			±100	nA	$V_{GS} = \pm 20\text{ V}, V_{DS} = 0$
$V_{GS(off)}$	Gate to Source Cutoff Voltage	1.5		3.5	V	$V_{DS} = 10\text{ V}, I_D = 1\text{ mA}$
$ Y_{fs} $	Forward Transfer Admittance	1.0			S	$V_{DS} = 10\text{ V}, I_D = 1\text{ A}$
$R_{DS(on)}$	Drain to Source On-State Resistance		2.5	3.2	Ω	$V_{GS} = 10\text{ V}, I_D = 1\text{ A}$
C_{iss}	Input Capacitance		950		pF	$V_{DS} = 10\text{ V}, V_{GS} = 0, f = 1\text{ MHz}$
C_{oss}	Output Capacitance		350		pF	
C_{rss}	Reverse Transfer Capacitance		200		pF	
$t_{d(on)}$	Turn-On Delay Time		10		ns	$I_D = 1\text{ A}, V_{DD} = 150\text{ V}$ $V_{GS(on)} = 10\text{ V}$ $R_L = 150\ \Omega$ $R_{in} = 10\ \Omega$
t_r	Rise Time		10		ns	
$t_{d(off)}$	Turn-Off Delay Time		60		ns	
t_f	Fall Time		20		ns	

Phase-out/Discontinued

TYPICAL CHARACTERISTICS ($T_a = 25^\circ\text{C}$)

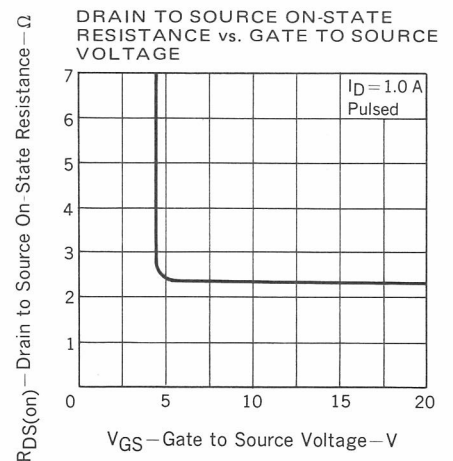
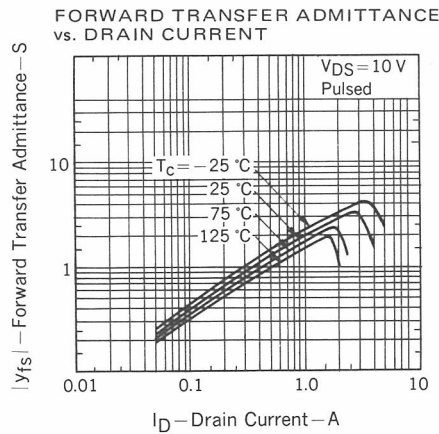
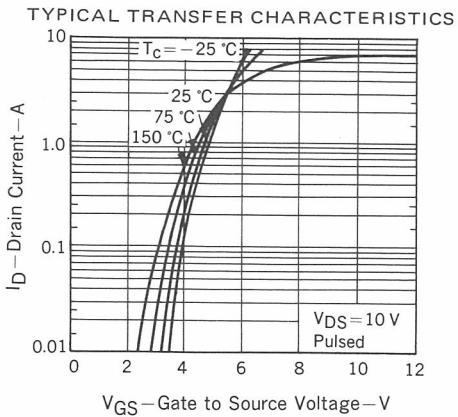
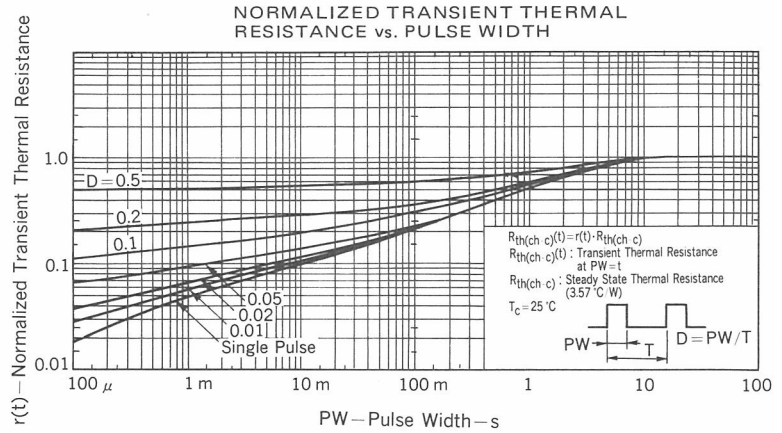
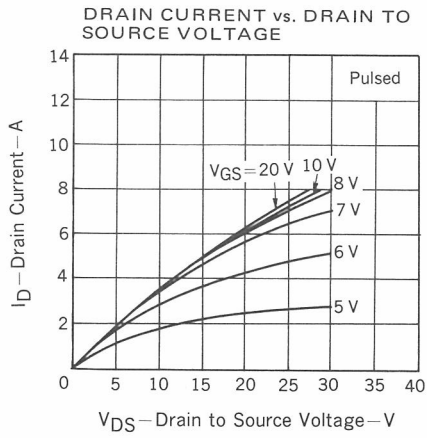
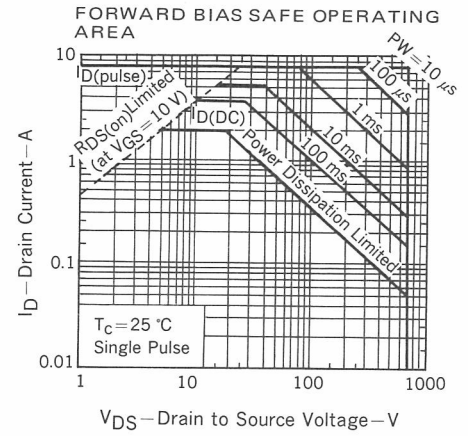
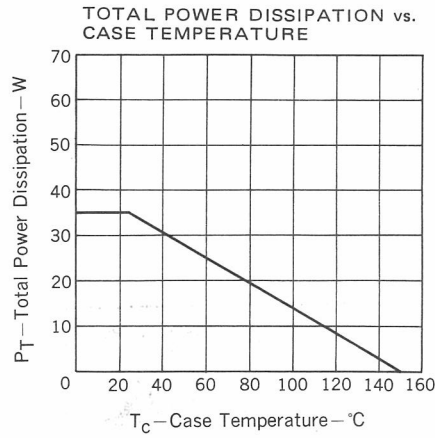
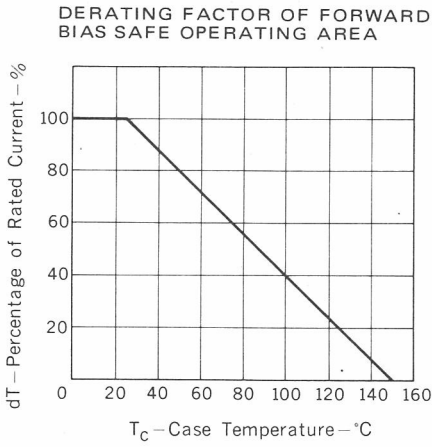

Phase-out/Discontinued

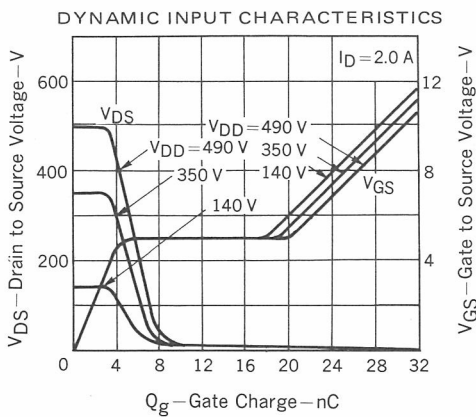
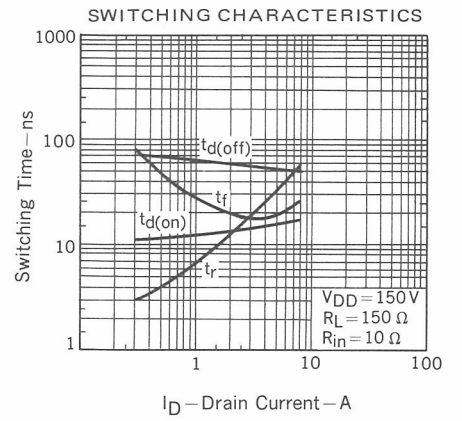
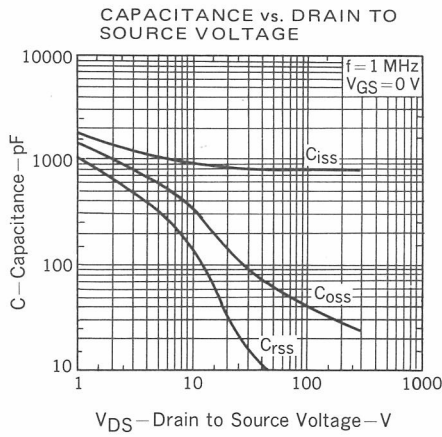
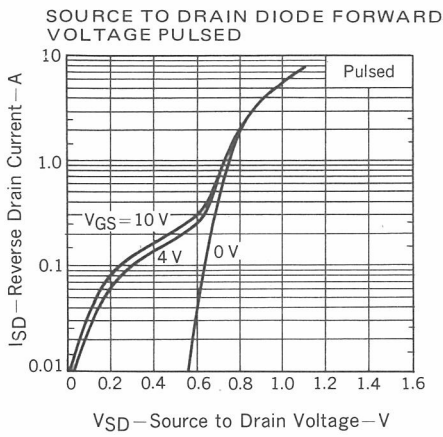
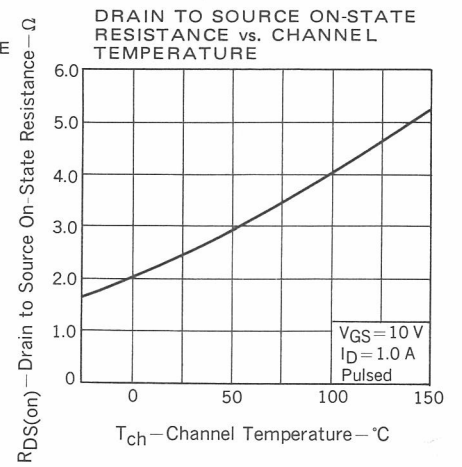
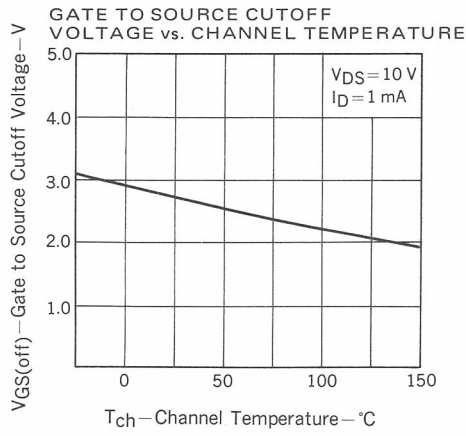
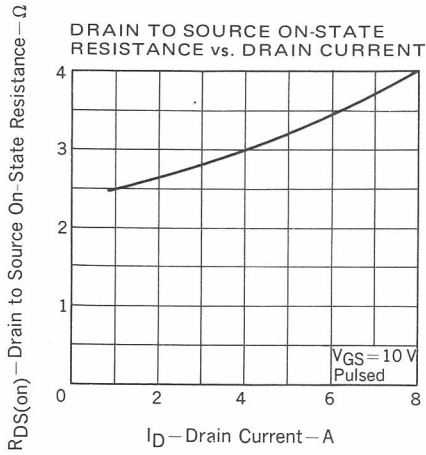

Phase-out/Discontinued

SWITCHING TIME TEST CIRCUIT 1

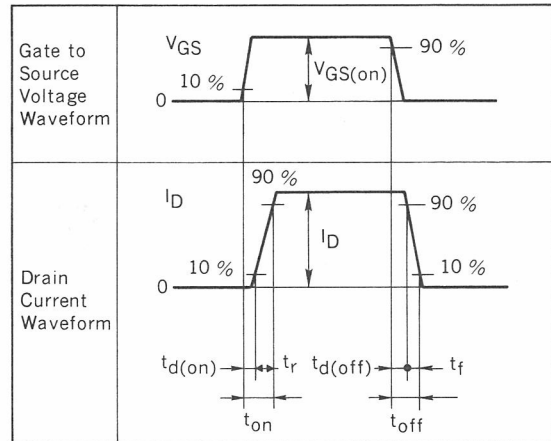
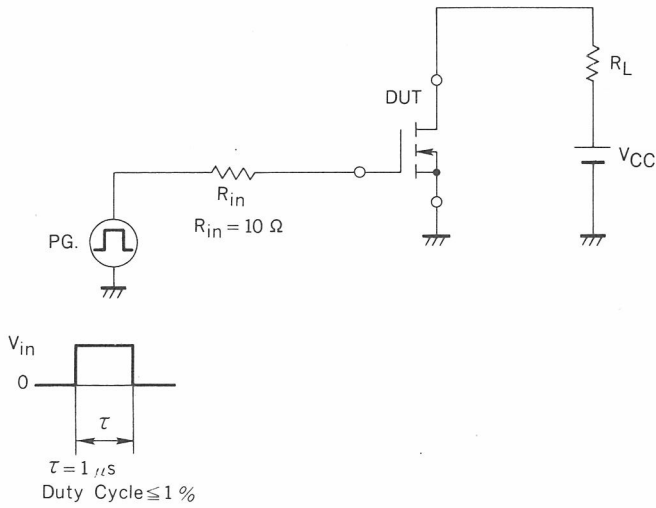

TEST CIRCUIT 2 GATE CHARGE

