

SILICON DIFFUSED POWER TRANSISTORS

High-voltage, high-speed, glass-passivated npn power transistors in a SOT93 envelope, intended for use in converters, inverters, switching regulators, motor control systems etc.

QUICK REFERENCE DATA

		BUW13	BUW13A	
Collector-emitter voltage (peak value; $V_{BE} = 0$)	V_{CESM} max.	850	1000	V
Collector-emitter voltage (open base)	V_{CEO} max.	400	450	V
Collector-emitter saturation voltage	V_{CEsat} max.	1.5		V
Collector current (DC)	I_C max.	15		A
Collector current (peak value)	I_{CM} max.	30		A
Total power dissipation up to $T_{mb} = 25\text{ }^\circ\text{C}$	P_{tot} max.	175		W
Fall time	t_f max.	0.8		μs

MECHANICAL DATA

Dimensions in mm

Fig. 1 SOT93.

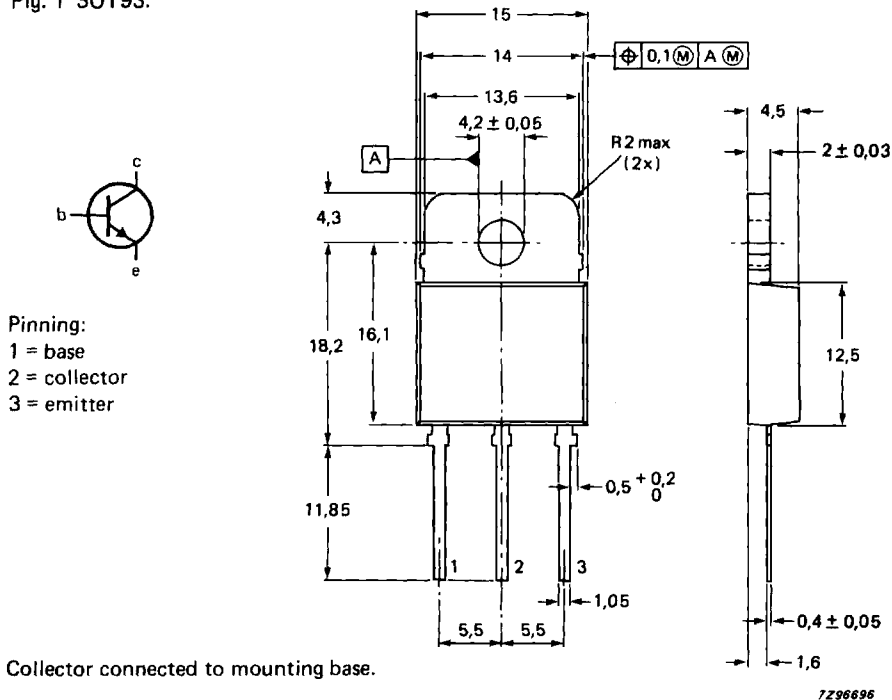

RATINGS

Limiting values in accordance with the Absolute Maximum System (IEC 134)

			BUW13	BUW13A	
Collector-emitter voltage (peak value, $V_{BE} = 0$)	V_{CESM}	max.	850	1000	V
Collector-emitter voltage (open base)	V_{CEO}	max.	400	450	V
Collector current (DC)	I_C	max.	15		A
Collector current (peak value); $t_p < 2$ ms	I_{CM}	max.	30		A
Base current (DC)	I_B	max.	6		A
Base current (peak value); $t_p < 2$ ms	I_{BM}	max.	9		A
Total power dissipation up to $T_{mb} = 25$ °C	P_{tot}	max.	175		W
Storage temperature range	T_{stg}		-65 to +150		°C
Junction temperature	T_j	max.	150		°C

THERMAL RESISTANCE

From junction to mounting base	R_{thj-mb}	=	0,7		K/W
--------------------------------	--------------	---	-----	--	-----

CHARACTERISTICS

$T_j = 25$ °C unless otherwise specified

Collector cut-off current*

$V_{CE} = V_{CESMmax}; V_{BE} = 0$

$V_{CE} = V_{CESMmax}; V_{BE} = 0; T_j = 125$ °C

I_{CES}	max.	1		mA
I_{CES}	max.	4		mA

Emitter cut-off current

$I_C = 0; V_{EB} = 9$ V

I_{EBO}	max.	10		mA
-----------	------	----	--	----

Saturation voltages

$I_C = 10$ A; $I_B = 2$ A

$I_C = 8$ A; $I_B = 1,6$ A

			BUW13	BUW13A	
V_{CEsat}	max.	1,5		—	V
V_{BEsat}	max.	1,6		—	V
V_{CEsat}	max.	—		1,5	V
V_{BEsat}	max.	—		1,6	V

DC current gain

$I_C = 20$ mA; $V_{CE} = 5$ V

$I_C = 1,5$ A; $V_{CE} = 5$ V

h_{FE}	min.	10		
h_{FE}	typ.	18		
h_{FE}	max.	35		
h_{FE}	min.	10		
h_{FE}	typ.	20		
h_{FE}	max.	35		

Collector-emitter sustaining voltage

$I_C = 100$ mA; $I_{Boff} = 0$; $L = 25$ mH

$V_{CEO_{sust}}$	min.	400		450	V
------------------	------	-----	--	-----	---

* Measured with a half-sinewave voltage (curve tracer).

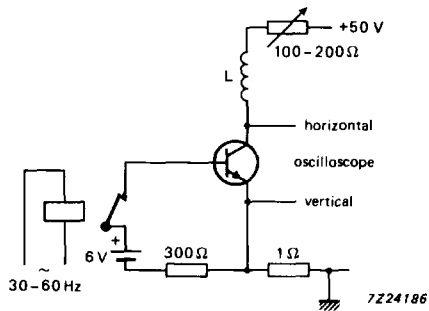

Fig. 2 Test circuit for $V_{CEOsust}$.

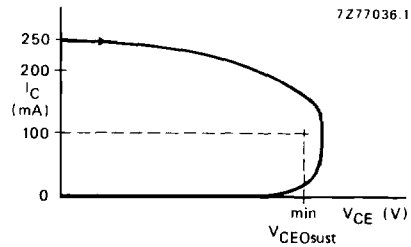

Fig. 3 Oscilloscope display for sustaining voltage.

Switching times resistive load (Figs 4 and 5)

$I_{Con} = 10\text{ A}$; $I_{Bon} = -I_{Boff} = 2\text{ A}$

Turn-on time

Turn-off: Storage time

Fall time

$I_{Con} = 8\text{ A}$; $I_{Bon} = -I_{Boff} = 1,6\text{ A}$

Turn-on time

Turn-off: Storage time

Fall time

Switching times inductive load (Figs 6 and 7)

$I_{Con} = 10\text{ A}$; $I_B = 2\text{ A}$

Turn-off: Storage time

Fall time

$I_{Con} = 10\text{ A}$; $I_B = 2\text{ A}$; $T_j = 100\text{ }^\circ\text{C}$

Turn-off: Storage time

Fall time

Switching times inductive load (Figs 6 and 7)

$I_{Con} = 8\text{ A}$; $I_B = 1,6\text{ A}$

Turn-off: Storage time

Fall time

$I_{Con} = 8\text{ A}$; $I_B = 1,6\text{ A}$; $T_j = 100\text{ }^\circ\text{C}$

Turn-off: Storage time

Fall time

		BUW13	BUW13A	
t_{on}	max.	1	—	μs
t_s	max.	4	—	μs
t_f	max.	0,8	—	μs
t_{on}	max.	—	1	μs
t_s	max.	—	4	μs
t_f	max.	—	0,8	μs
t_s	typ.	2,3	—	μs
	max.	3,0	—	μs
t_f	typ.	80	—	ns
	max.	150	—	ns
t_s	typ.	2,5	—	μs
	max.	3,2	—	μs
t_f	typ.	140	—	ns
	max.	300	—	ns
t_s	typ.	—	2,3	μs
	max.	—	3,0	μs
t_f	typ.	—	80	ns
	max.	—	150	ns
t_s	typ.	—	2,5	μs
	max.	—	3,2	μs
t_f	typ.	—	140	ns
	max.	—	300	ns

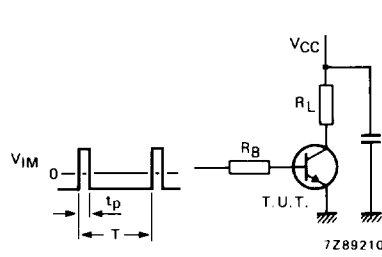

$V_{CC} = 250 \text{ V}$
 $V_{IM} = -6 \text{ to } +8 \text{ V}$
 $t_p = 20 \mu\text{s}$
 $\frac{t_p}{T} = 0,01$

The values of R_B and R_L are selected in accordance with $I_{C on}$ and I_B requirements.

Fig. 4 Test circuit resistive load.

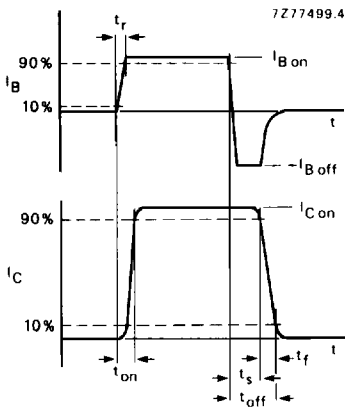

Fig. 5 Switching times waveforms with resistive load.

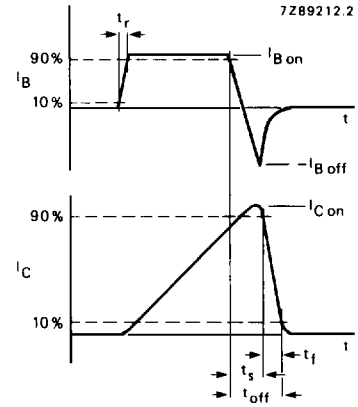
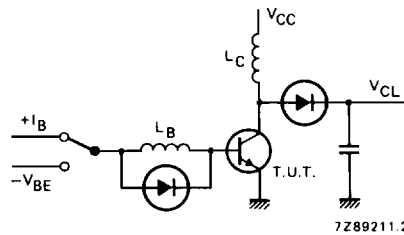
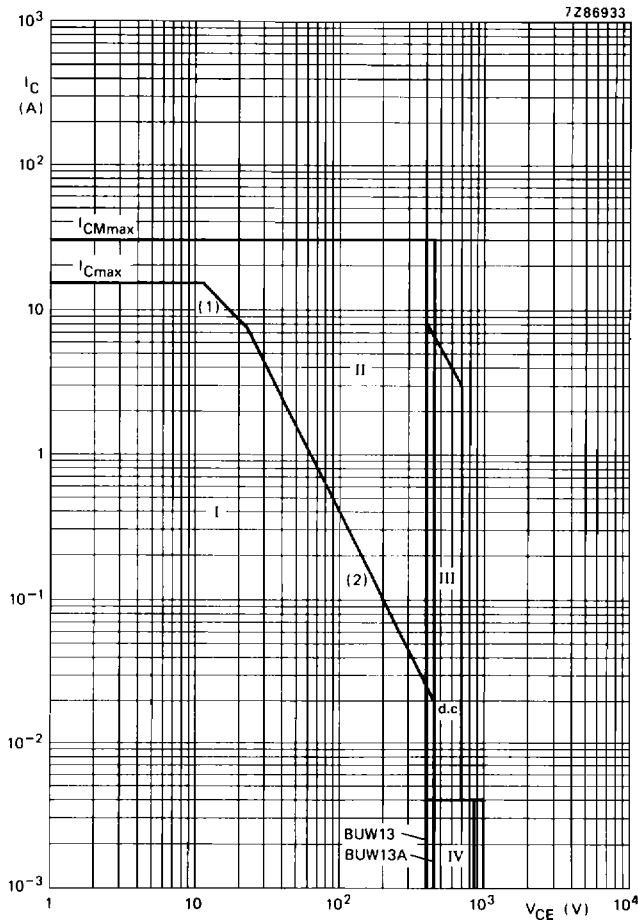

Fig. 6 Switching times waveforms with inductive load.



$V_{CL} = 300 \text{ V}$
 $V_{CC} = 30 \text{ V}$
 $-V_{BE} = 5 \text{ V}$
 $L_B = 1 \mu\text{H}$
 $L_C = 200 \mu\text{H}$

Fig. 7 Test circuit inductive load.



(1) P_{tot} max line.

(2) Second-breakdown limits.

I Region of permissible DC operation.

II Permissible extension for repetitive pulse operation.

III Area of permissible operation during turn-on in single transistor converters, provided $R_{BE} \leq 100 \Omega$ and $t_p \leq 0,6 \mu s$.

IV Repetitive pulse operation in this region is permissible provided $V_{BE} \leq 0$ and $t_p \leq 5 ms$.

Fig. 8 Safe operating area at $T_{mb} \leq 25^\circ C$.

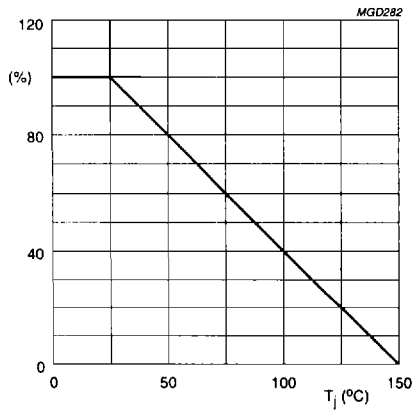

Fig. 9 Total power dissipation.

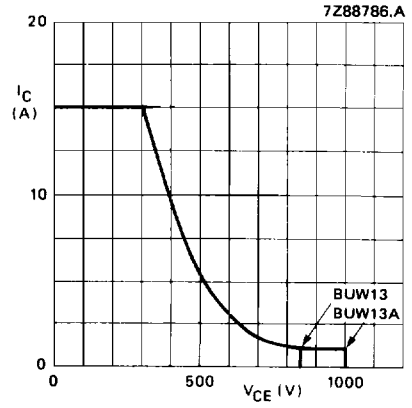

Fig. 10 Reverse bias SOAR.

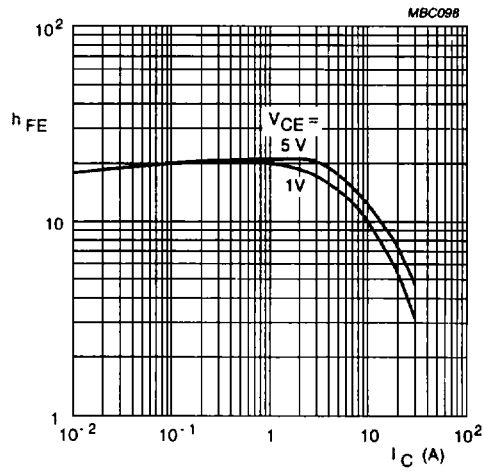

Fig.11 Typical values DC current gain.

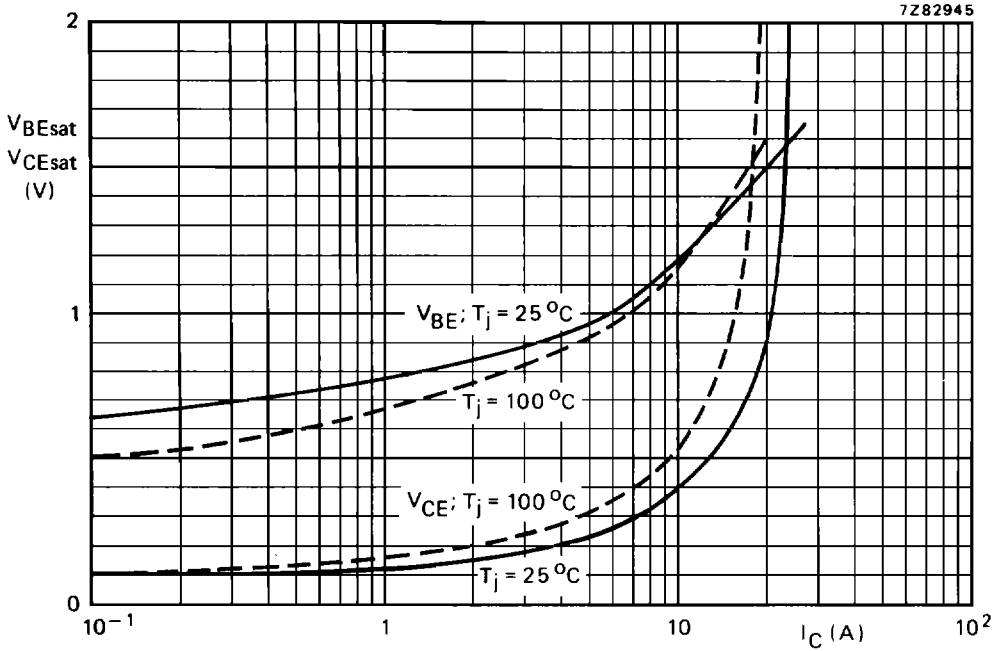

Fig. 12 Typical values base and collector voltage at $I_C/I_B = 5$.

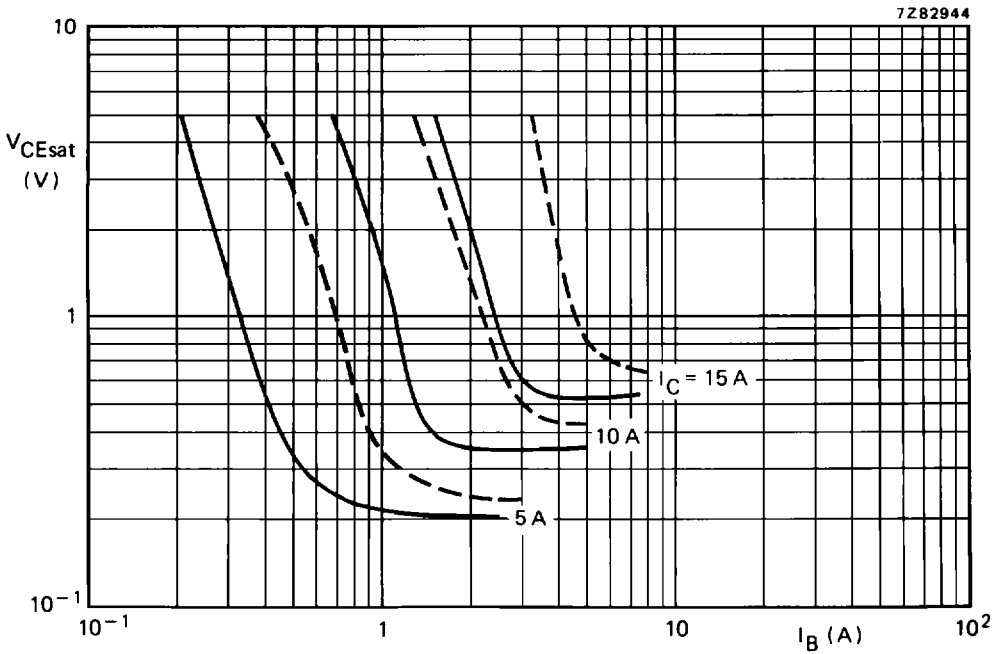

Fig. 13 Typical (—) and maximum (---) values saturation voltage. $T_j = 25^\circ\text{C}$.

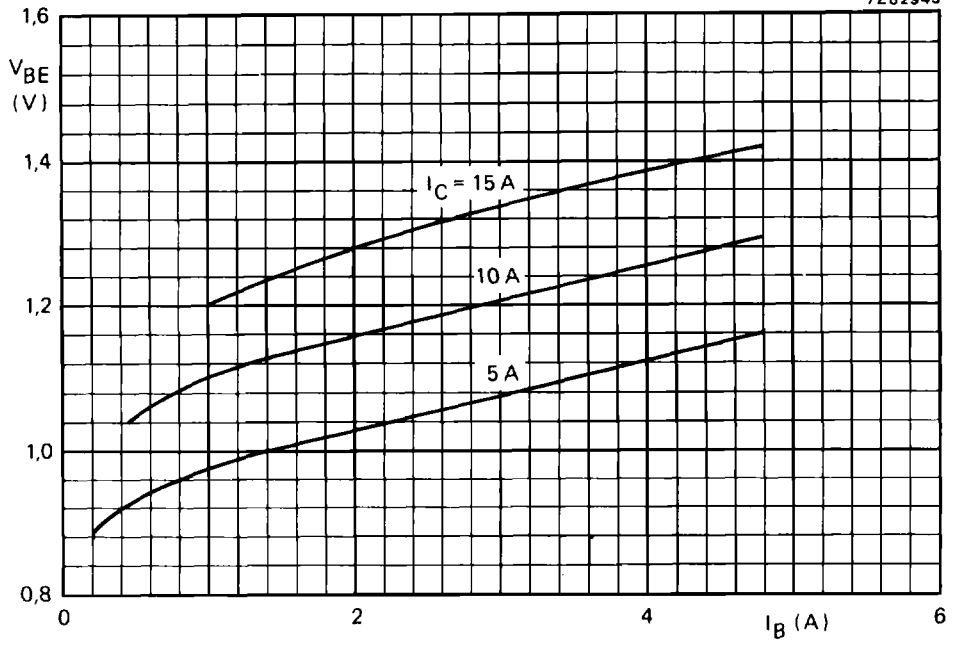

Fig. 14 Typical values base-emitter voltage at $T_j = 25$ °C.