

HA13128, HA13135

22 W Dual BTL Audio Power Amplifier

The HA13128/HA13135 provide high output power 22 W with 10 % THD at $V_{CC} = 14.4$ V, $R_L = 4 \Omega$, and built-in 2ch BTL amplifiers, stand-by circuit and 4 type protectors.

HA13128/HA13135 are pin to pin with HA13127/130, 17 W output power.

Features

- Small pop noise
- Less external component counts
- Smaller size package and easy to mount (16 pins)
- Built-in 4 type protectors (Surge protector, TSD, output to GND short protect, output to V_{CC} short protect)
- Built-in stand-by (Mute) circuit

Ordering Information

Type No.	Voltage gain	Package
HA13128	50 dB	16 pin SIP with heat sink
HA13135	40 dB	



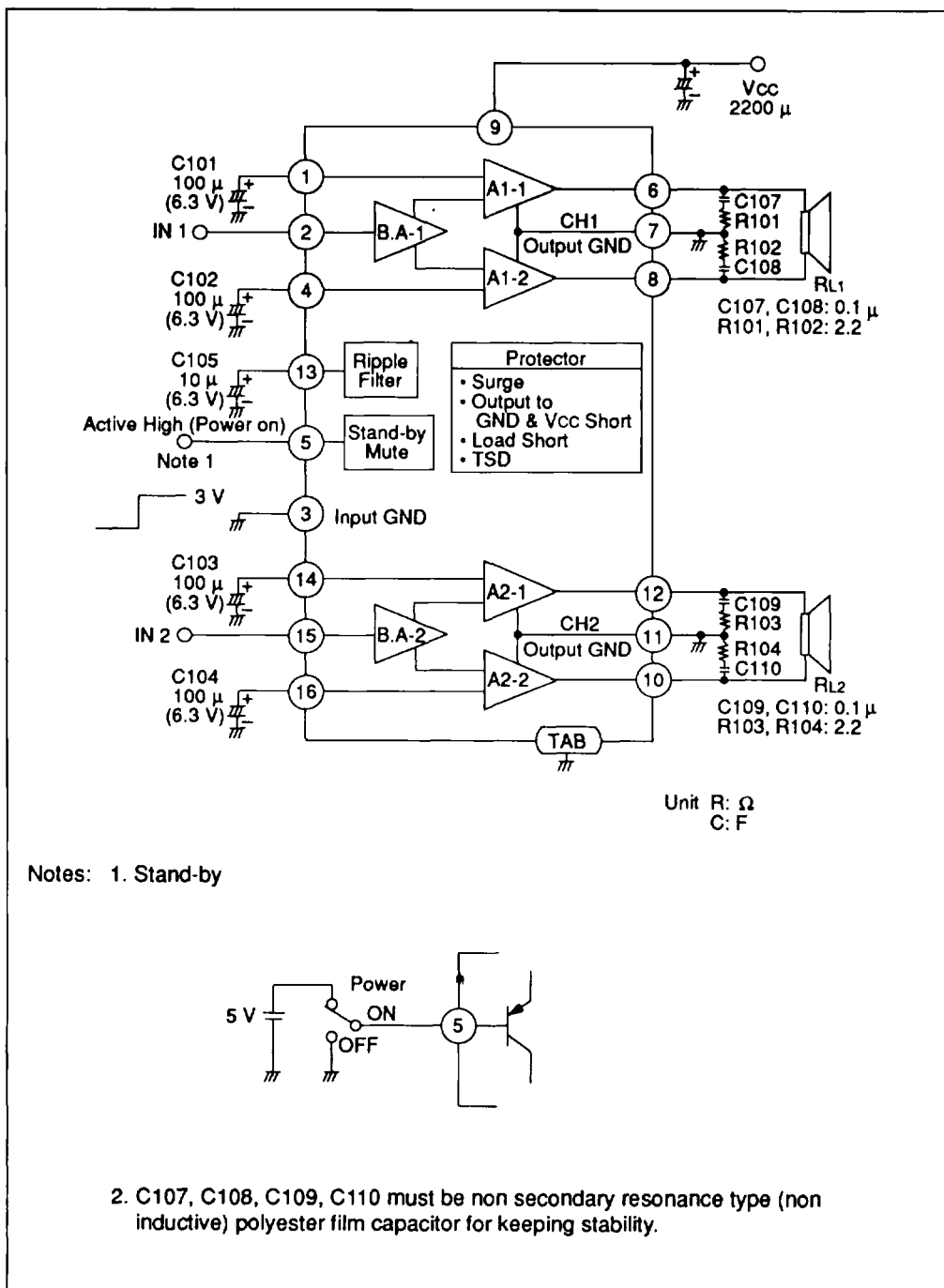

Figure 1 Block Diagram



HA13128, HA13135

Absolute Maximum Ratings (Ta = 25 °C)

Item	Symbol	Rating	Unit	Notes
Operating supply voltage	Vcc	18	V	
DC supply voltage	Vcc (DC)	26	V	1
Peak supply voltage	Vcc (peak)	50	V	2
Output current	Io (peak)	4	A	3
Power dissipation	Pr	25	W	
Thermal resistance	θj-c	3	°C/W	
Junction temperature	Tj	150	°C	
Operating temperature	Topr	-30 to +85	°C	
Storage temperature	Tstg	-55 to +125	°C	

Notes: 1. Value at $t \leq 30$ sec

2. Value at surge pulse width ≤ 200 ms (rise time $t_r \geq 1$ ms)

3. Value at per channel

Electrical Characteristics (Vcc = 13.2 V, f = 1 kHz, RL = 4 Ω)

Item	Symbol	HA13128 (Gv = 50 dB)			HA13135 (Gv = 40 dB)			Unit	Test Condition
		Min	Typ	Max	Min	Typ	Max		
Quiescent current	Iq1	60	150	250	60	150	250	mA	Vin=0 V
Input bias voltage	Vb	—	20	40	—	20	40	mA	Vin=0 V
Output offset voltage	ΔVo	—	—	150	—	—	150	mV	Vin=0 V
Voltage gain	Gv	48.5	50	51.5	38.5	40	41.5	dB	
Difference of voltage gain	ΔGv	—	—	1.5	—	—	1.5	dB	
Output power (1)	Po1	14	18	—	14	18	—	W	THD=10 %, RL=4 Ω
Output power (2)	Po2	—	13	—	—	14	—	W	THD=1 %, RL=4 Ω
Total harmonic distortion	THD	—	0.15	0.7	—	0.04	0.15	%	Po=3 W 1 kHz
		—	0.18	—	—	0.15	—		Po=1.5 W 20 kHz



HA13128, HA13135

Electrical Characteristics (V_{CC} = 13.2 V, f = 1 kHz, R_L = 4 Ω) (cont)

Noise Output	WBN ₁	—	1.0	2.0	—	0.35	0.7	mV	R _g =10 kΩ, BW=20 Hz to 20 kHz
	WBN ₂	—	0.8	1.7	—	0.25	0.5	mV	R _g =0, BW=20 Hz to 20 kHz
Supply voltage ripple rejections	SVR	32	40	—	45	60	—	dB	f=500 Hz
Roll-off frequency		—	20	—	—	10	—	Hz	ΔGv=-3 dB Low from f=1 kHz
		10	20	40	30	70	140	kHz	High
Stand-by (Mute) current	I _{o2}	—	50	200	—	50	200	μA	V _{in} =0, V _Ⓢ =1.0 V
Stand-by (Mute) threshold voltage	V _{TH} (H)	5	—	V _{CC} -1	5	—	V _{CC} -1	V	V _{in} = Output on -40 dBm
	V _{TH} (L)	0	—	1.0	0	—	1.0	V	Output off
Mute attenuation	ATT	45	60	—	45	60	—	dB	V _{in} =-55 dB V _Ⓢ =1.0 V
Input impedance	R _{in}	20	30	40	20	30	40	kΩ	
Mute on time		—	10	—	—	10	—	μs	
Mute off time		—	0.8	—	—	0.8	—	sec	
V _{out} rise time		—	0.8	—	—	0.8	—	sec	
Channel cross-talk	CT	40	50	—	45	60	—	dB	V _{out} =0 dBm
Output power	P _o	—	19	—	—	19	—	W	THD=10 % 1 channel operation
Output power (3)	P _{o3}	—	22	—	—	22	—	W	V _{CC} =14.4 V, THD=10 %, R _L =4 Ω
Output power (4)	P _{o4}	—	11	—	—	11	—	W	THD=10 %, R _L =8 Ω
Output Power (5)	P _{o5}	—	8	—	—	8	—	W	THD=1 %, R _L =8 Ω



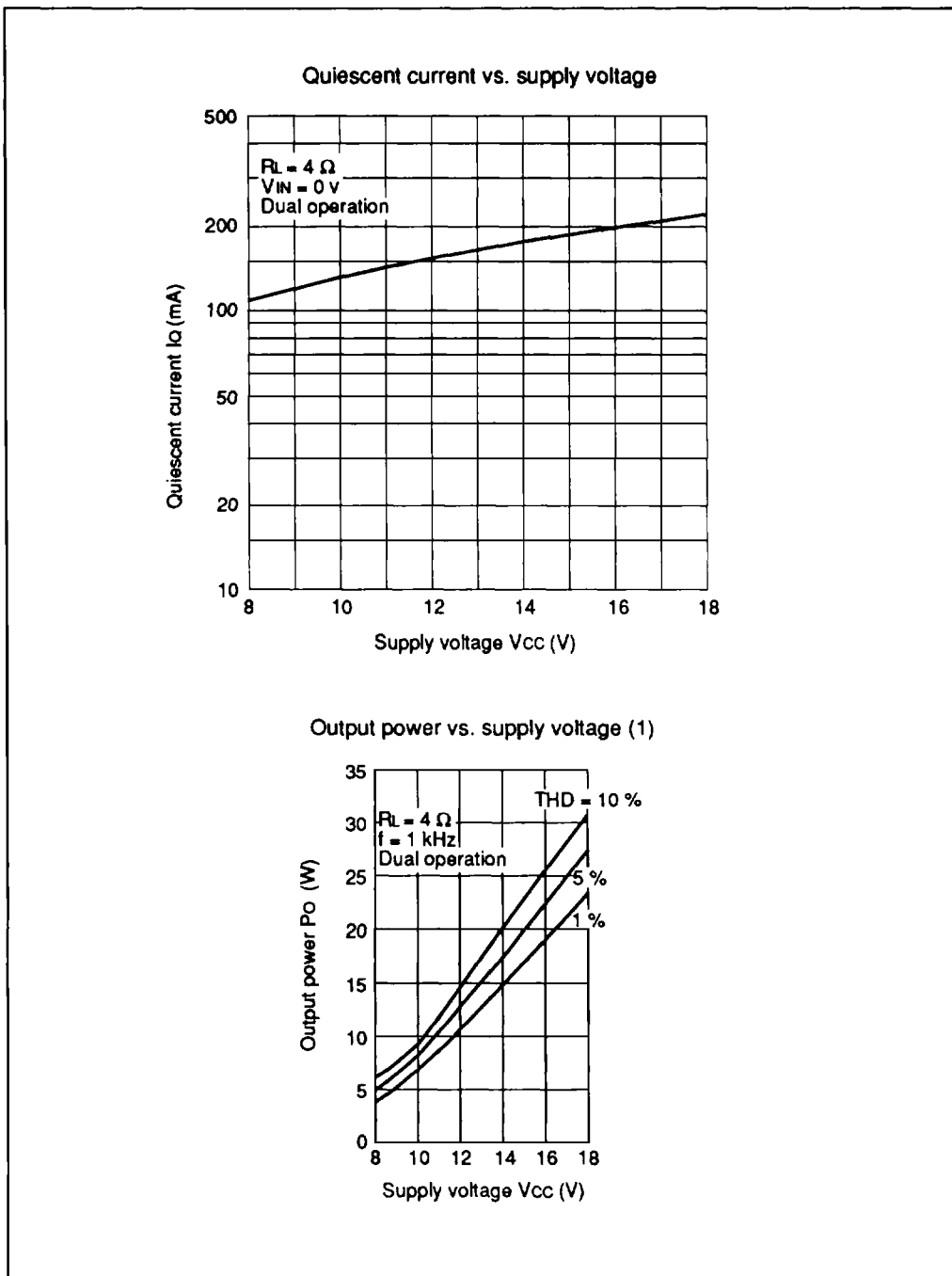
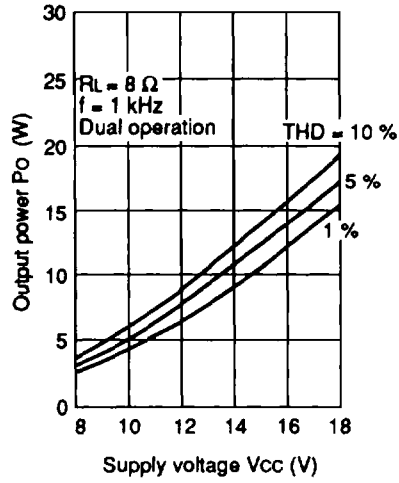

Figure 2 HA13135 Characteristic Curves



Output power vs. supply voltage (2)



Voltage gain vs. frequency

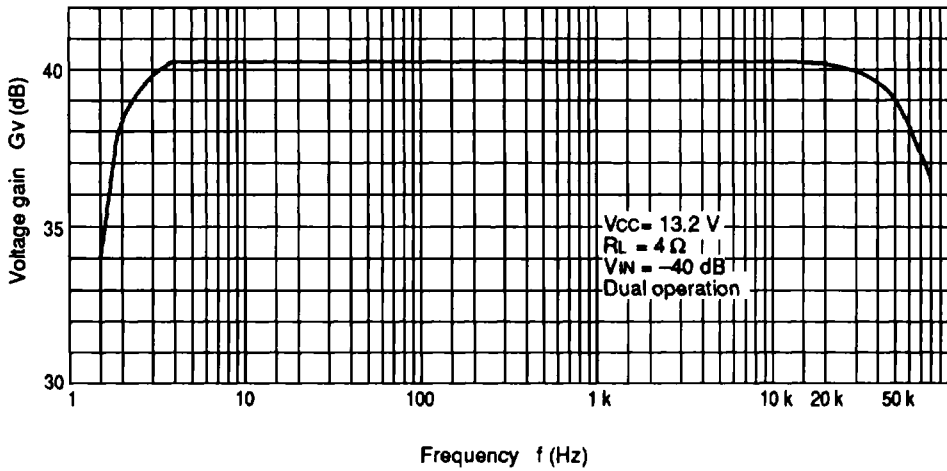
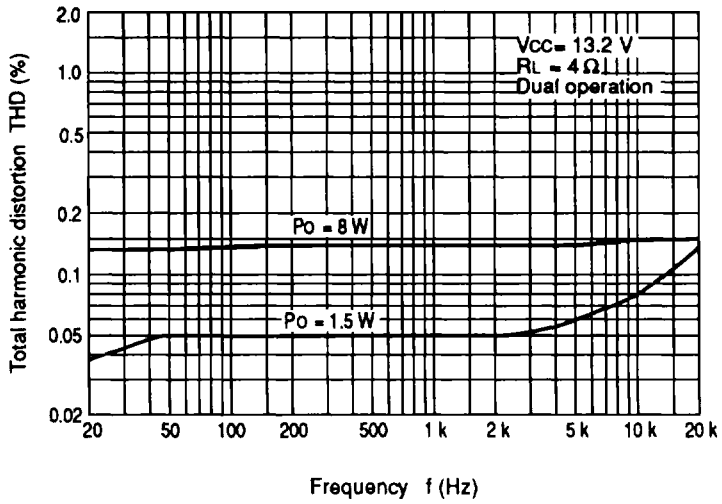

Figure 2 HA13135 Characteristic Curves (cont)



Total harmonic distortion vs. frequency



Total harmonic distortion vs. output power

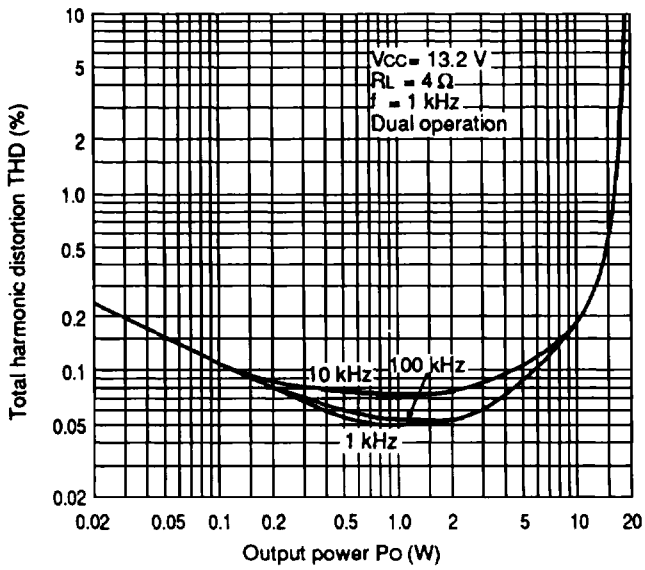

Figure 2 HA13135 Characteristic Curves (cont)



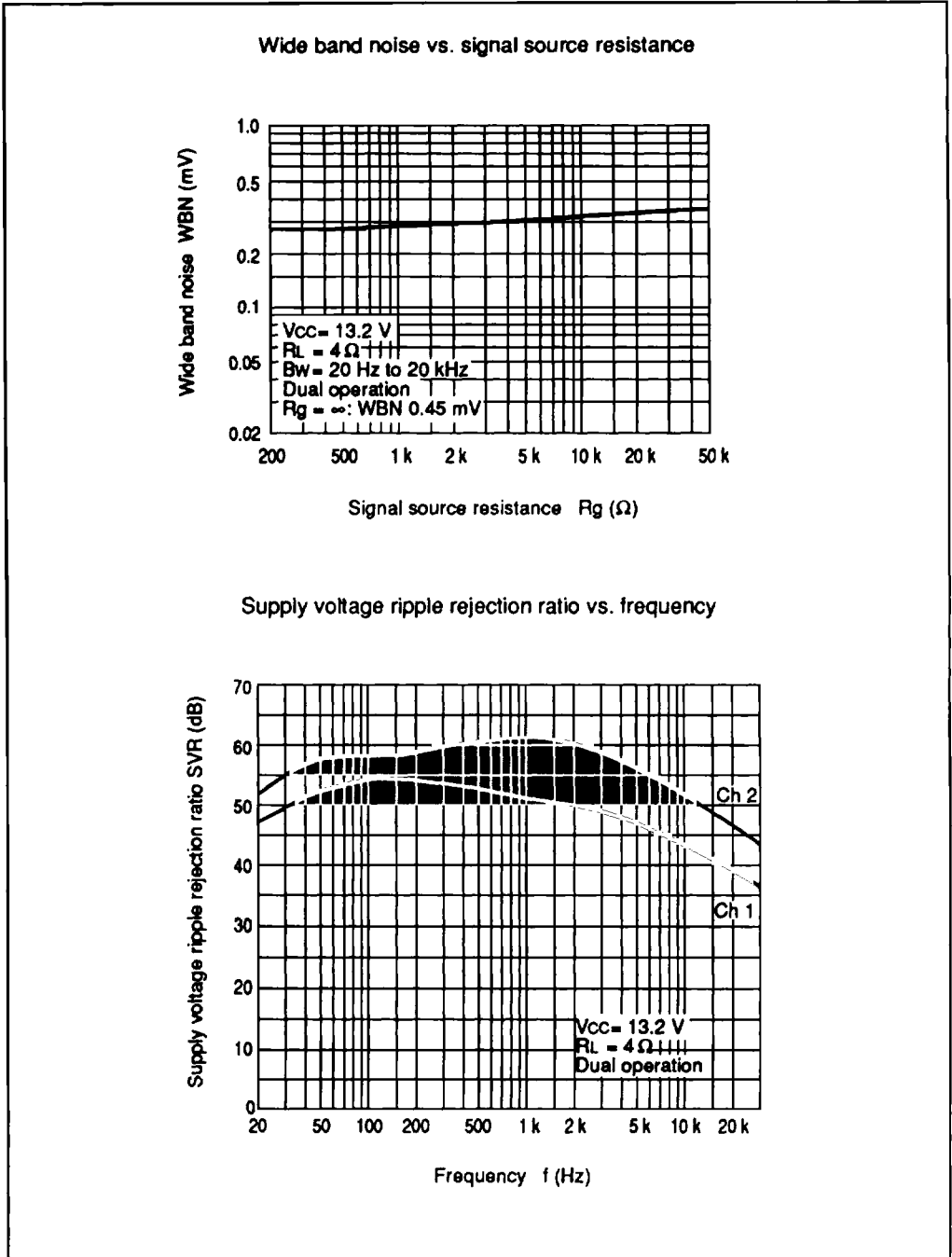

Figure 2 HA13135 Characteristic Curves (cont)



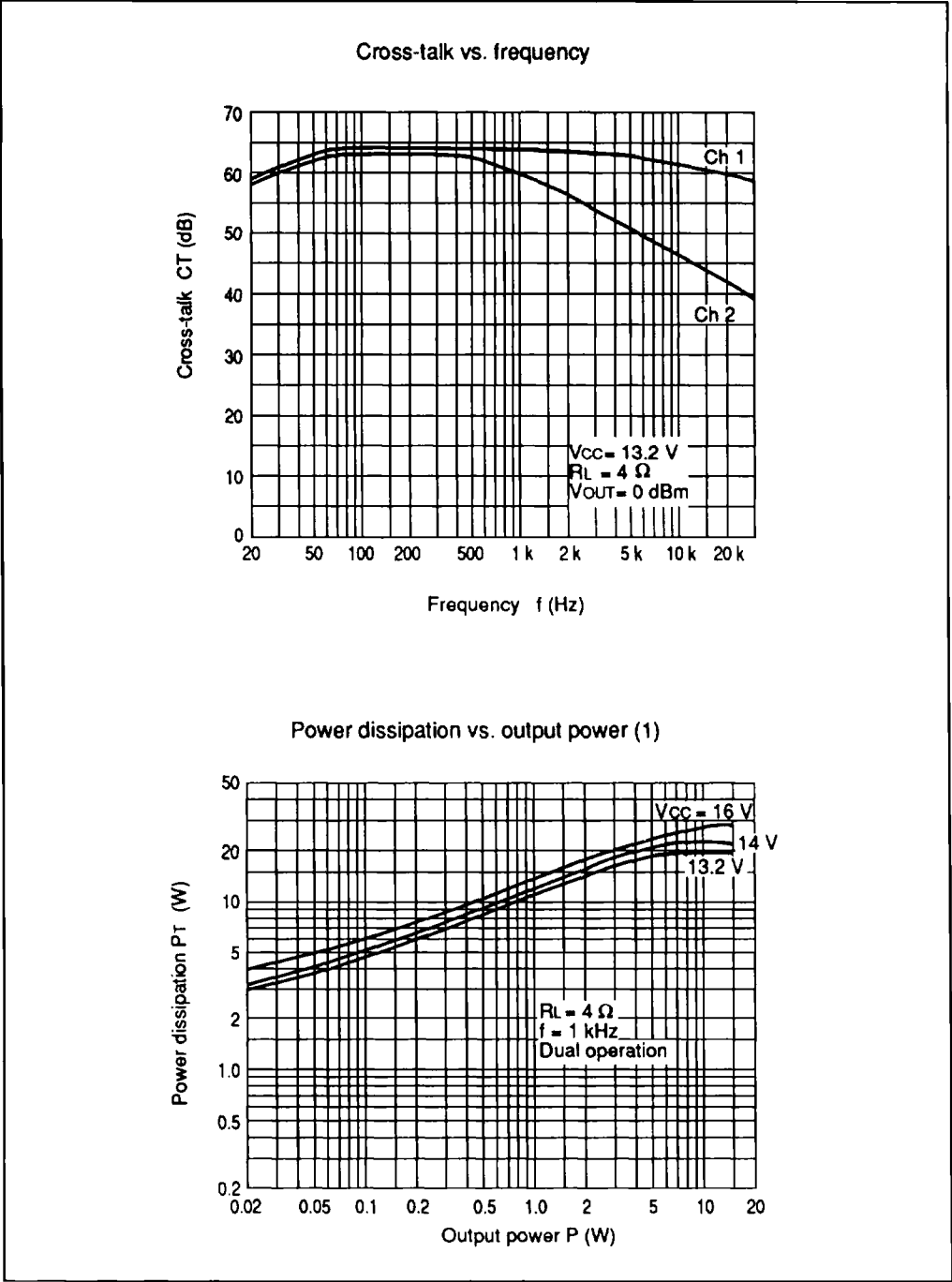

Figure 2 HA13135 Characteristic Curves (cont)



HA13128, HA13135

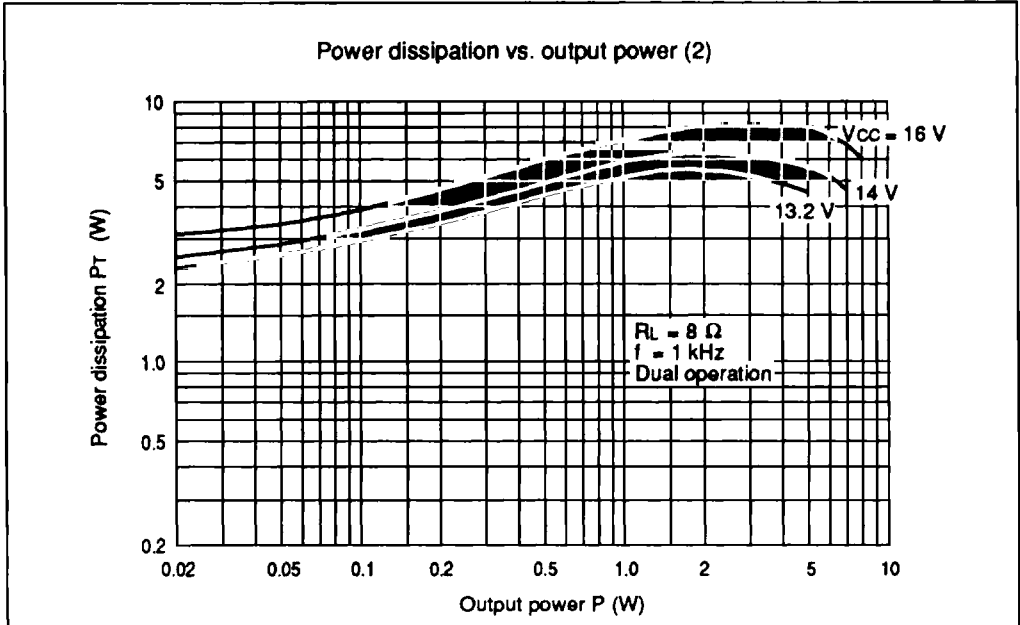

Figure 2 HA13135 Characteristic Curves (cont)

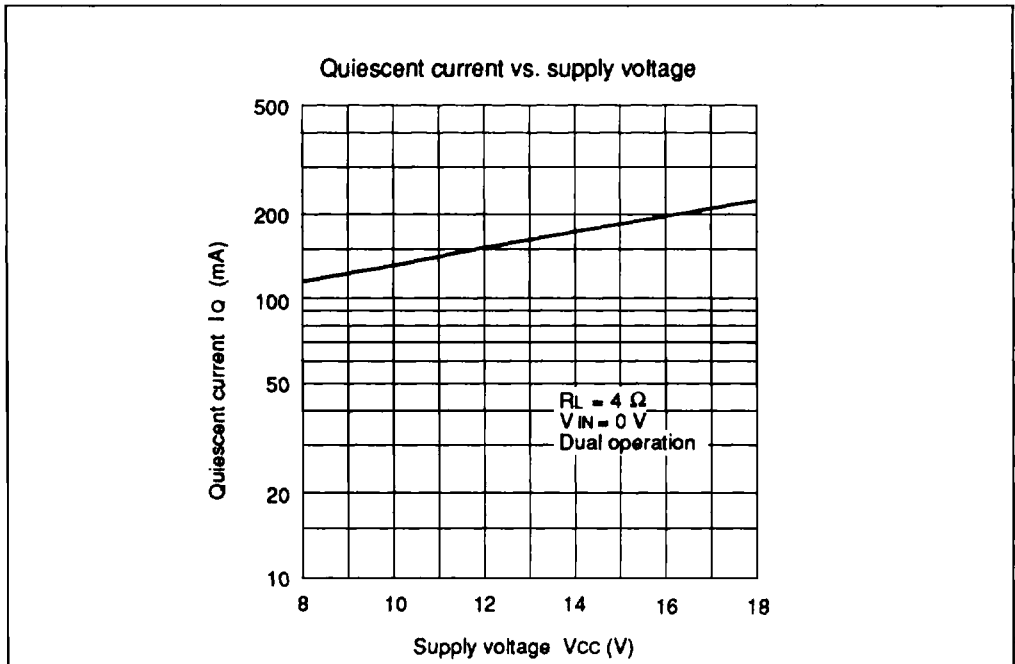

Figure 3 HA13128 Characteristic Curves



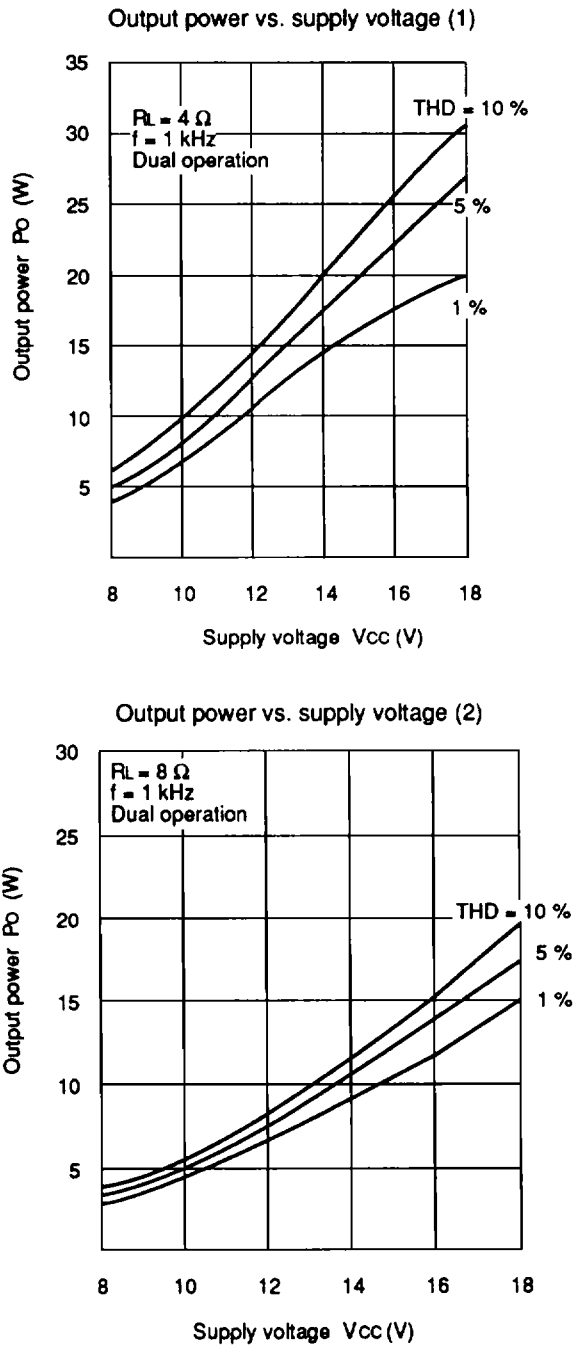

Figure 3 HA13128 Characteristic Curves (cont)



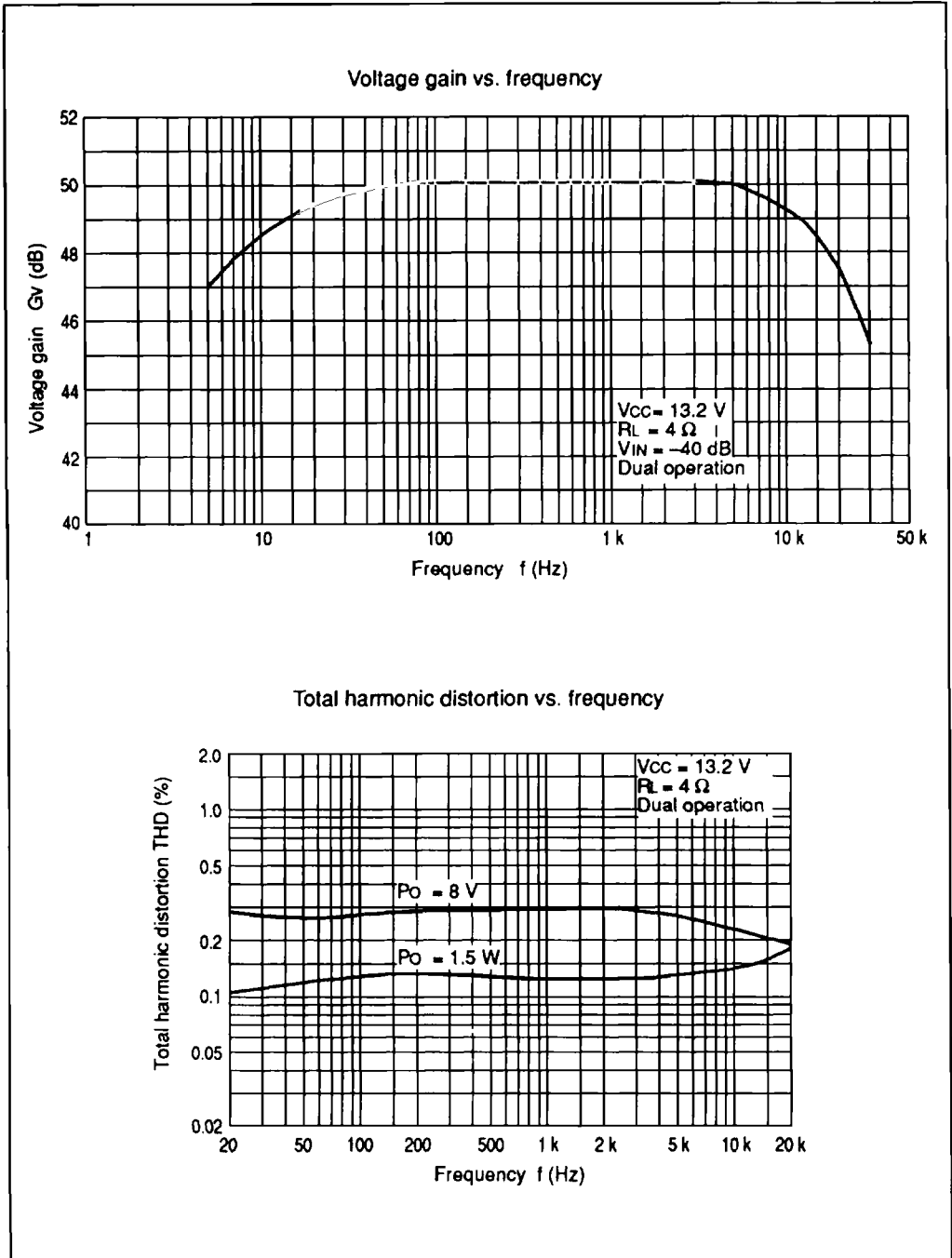

Figure 3 HA13128 Characteristic Curves (cont)



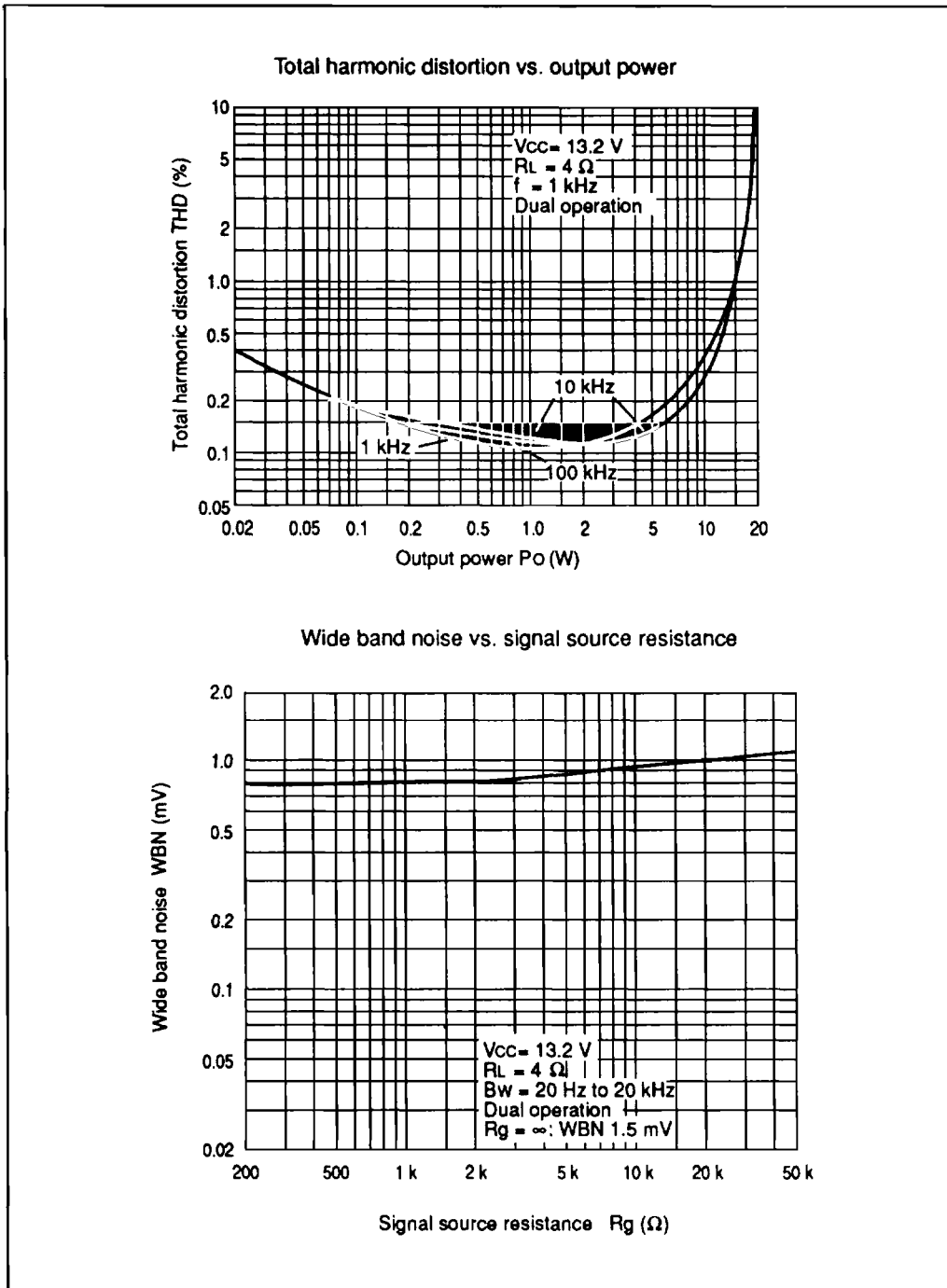

Figure 3 HA13128 Characteristic Curves (cont)



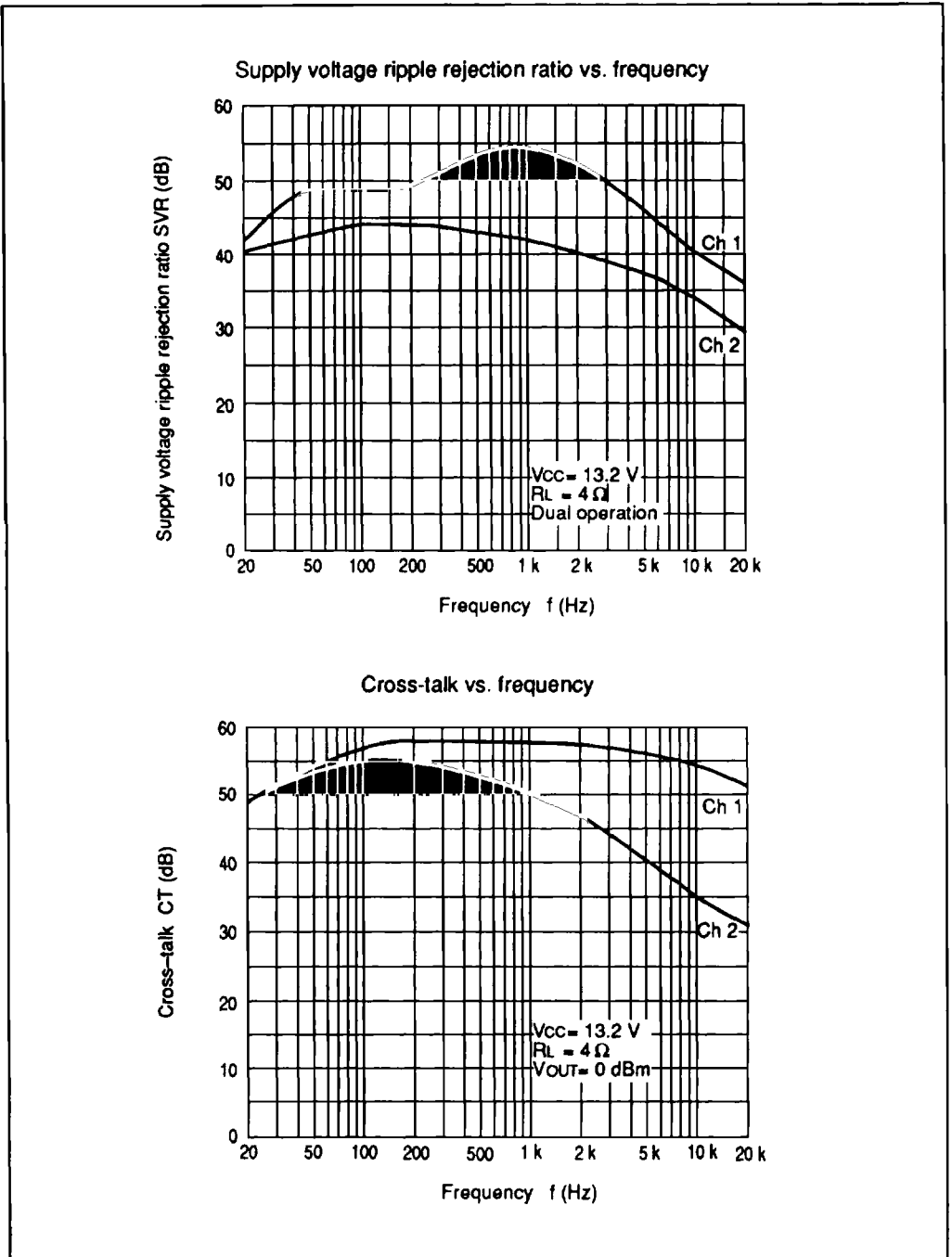

Figure 3 HA13128 Characteristic Curves (cont)



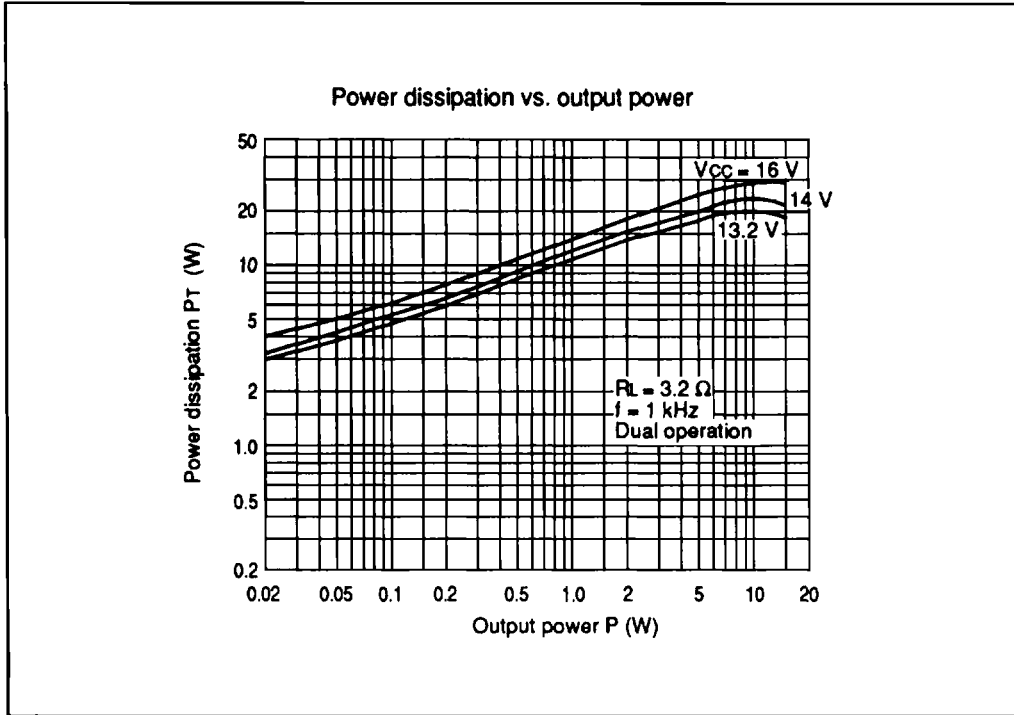

Figure 3 HA13128 Characteristic Curves (cont)

