

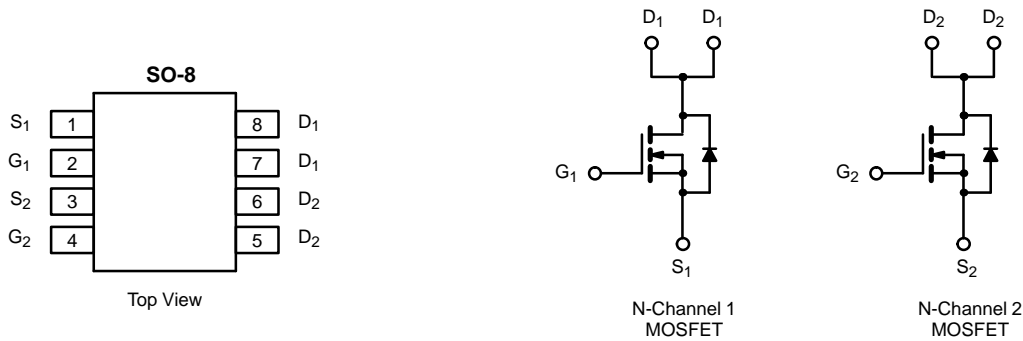

Dual N-Channel 30-V (D-S) MOSFET

PRODUCT SUMMARY			
	V _{DS} (V)	r _{DS(on)} (Ω)	I _D (A)
Channel-1	30	0.022 @ V _{GS} = 10 V	7.5
		0.030 @ V _{GS} = 4.5 V	6.5
Channel-2		0.0135 @ V _{GS} = 10 V	9.8
		0.0175 @ V _{GS} = 4.5 V	8.5



ABSOLUTE MAXIMUM RATINGS (T _A = 25°C UNLESS OTHERWISE NOTED)							
Parameter	Symbol	Channel-1		Channel-2		Unit	
		10 secs	Steady State	10 secs	Steady State		
Drain-Source Voltage	V _{DS}	30				V	
Gate-Source Voltage	V _{GS}	±20					
Continuous Drain Current (T _J = 150°C) ^a	I _D	T _A = 25°C	7.5	5.8	9.8	7.5	A
		T _A = 70°C	6	4.6	7.8	6	
Pulsed Drain Current	I _{DM}	30		40		A	
Continuous Source Current (Diode Conduction) ^a	I _S	1.8	1.06	1.8	1.06		
Maximum Power Dissipation ^a	P _D	T _A = 25°C	2	1.17	2	1.17	W
		T _A = 70°C	1.78	0.75	1.28	0.75	
Operating Junction and Storage Temperature Range	T _J , T _{stg}	-55 to 150				°C	

THERMAL RESISTANCE RATINGS							
Parameter	Symbol	Channel-1		Channel-2		Unit	
		Typ	Max	Typ	Max		
Maximum Junction-to-Ambient ^a	R _{thJA}	t ≤ 10 sec	55	62.5	53	62.5	°C/W
		Steady-State	89	107	89	107	
Maximum Junction-to-Foot (Drain)	R _{thJC}	36	45	34	42		

Notes
a. Surface Mounted on 1" x 1" FR4 Board.



MOSFET SPECIFICATIONS (T _J = 25°C UNLESS OTHERWISE NOTED).							
Parameter	Symbol	Test Condition	Min	Typ	Max	Unit	
Static							
Gate Threshold Voltage	V _{GS(th)}	V _{DS} = V _{GS} , I _D = 250 μA	Ch-1	0.8		V	
			Ch-2	1.0			
Gate-Body Leakage	I _{GSS}	V _{DS} = 0 V, V _{GS} = 20 V	Ch-1		100	nA	
			Ch-2		100		
Zero Gate Voltage Drain Current	I _{DSS}	V _{DS} = 24 V, V _{GS} = 0 V	Ch-1		1	μA	
			Ch-2		1		
		V _{DS} = 24 V, V _{GS} = 0 V, T _J = 85°C	Ch-1		15		
			Ch-2		15		
On-State Drain Current ^a	I _{D(on)}	V _{DS} = 5 V, V _{GS} = 10 V	Ch-1	20		A	
			Ch-2	30			
Drain-Source On-State Resistance ^a	r _{DS(on)}	V _{GS} = 10 V, I _D = 7.5 A	Ch-1		0.018	0.022	Ω
		V _{GS} = 10 V, I _D = 9.8 A	Ch-2		0.011	0.0135	
		V _{GS} = 4.5 V, I _D = 6.5 A	Ch-1		0.024	0.030	
		V _{GS} = 4.5 V, I _D = 8.5 A	Ch-2		0.0145	0.0175	
Forward Transconductance ^a	g _{fs}	V _{DS} = 15 V, I _D = 7.5 A	Ch-1		17	S	
		V _{DS} = 15 V, I _D = 9.8 A	Ch-2		30		
Diode Forward Voltage ^a	V _{SD}	I _S = 1.8 A, V _{GS} = 0 V	Ch-1		0.72	1.1	V
		I _S = 1.8 A, V _{GS} = 0 V	Ch-2		0.72	1.1	
Dynamic^b							
Total Gate Charge	Q _g	Channel-1 V _{DS} = 15 V, V _{GS} = 5 V, I _D = 7.5 A Channel-2 V _{DS} = 15 V, V _{GS} = 5 V, I _D = -9.8 A	Ch-1		8.0	12	nC
			Ch-2		23	34	
Gate-Source Charge	Q _{gs}		Ch-1		1.75		
			Ch-2		8.6		
Gate-Drain Charge	Q _{gd}		Ch-1		3.2		
			Ch-2		7.2		
Turn-On Delay Time	t _{d(on)}	Channel-1 V _{DD} = 15 V, R _L = 15 Ω I _D ≅ 1 A, V _{GEN} = 10 V, R _G = 6 Ω	Ch-1		10	20	ns
		Ch-2		17	30		
Rise Time	t _r	Channel-1	Ch-1		5	10	
		Channel-2	Ch-2		10	20	
Turn-Off Delay Time	t _{d(off)}	Channel-1	Ch-1		26	50	
		Channel-2	Ch-2		60	100	
Fall Time	t _f	Channel-1	Ch-1		10	16	
		Channel-2	Ch-2		17	30	
Source-Drain Reverse Recovery Time	t _{rr}	I _F = 1.8 A, di/dt = 100 A/μs	Ch-1		30	60	
		I _F = 1.8 A, di/dt = 100 μA/μs	Ch-2		40	70	

Notes

- a. Pulse test; pulse width ≤ 300 μs, duty cycle ≤ 2%.
b. Guaranteed by design, not subject to production testing.



TYPICAL CHARACTERISTICS (25°C UNLESS NOTED) **CHANNEL-1**

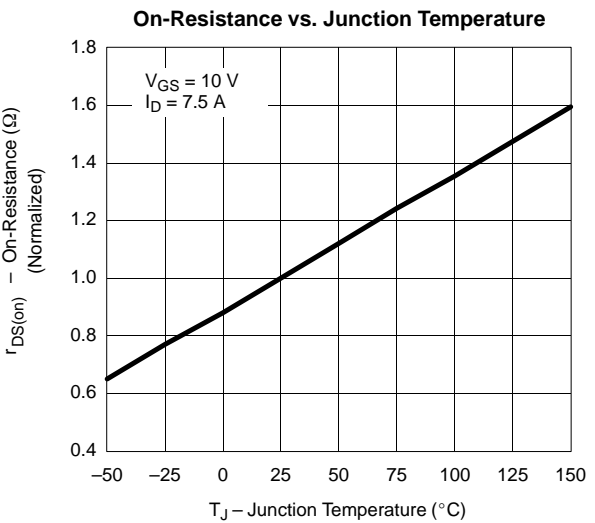
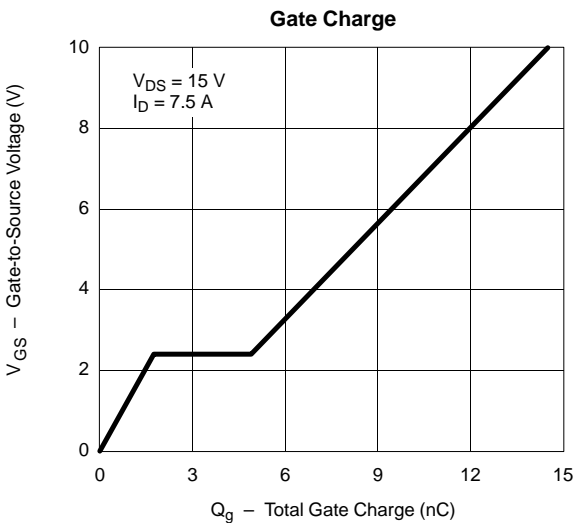
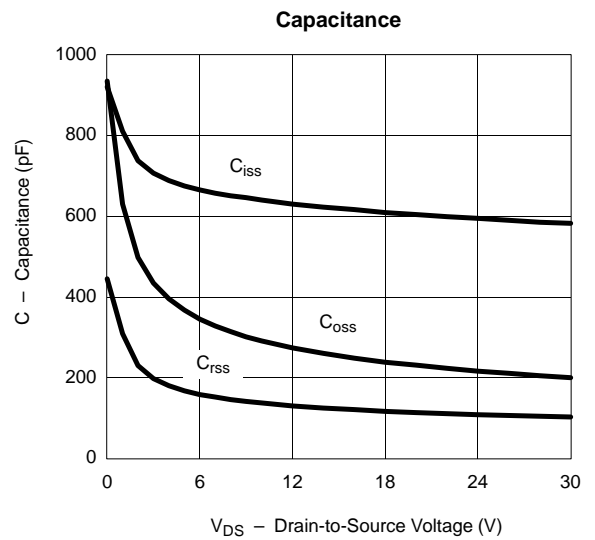
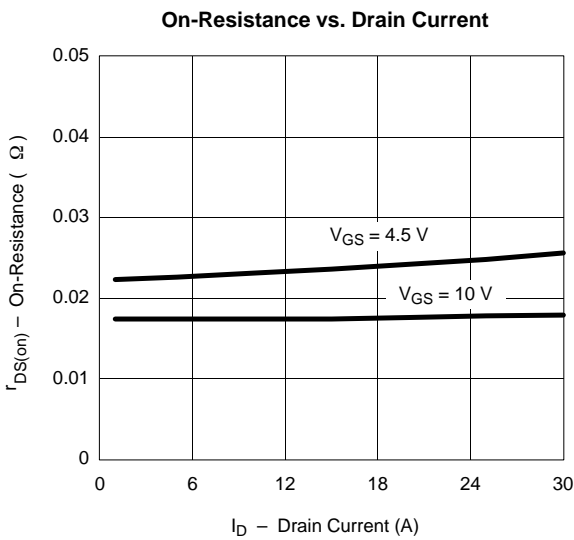
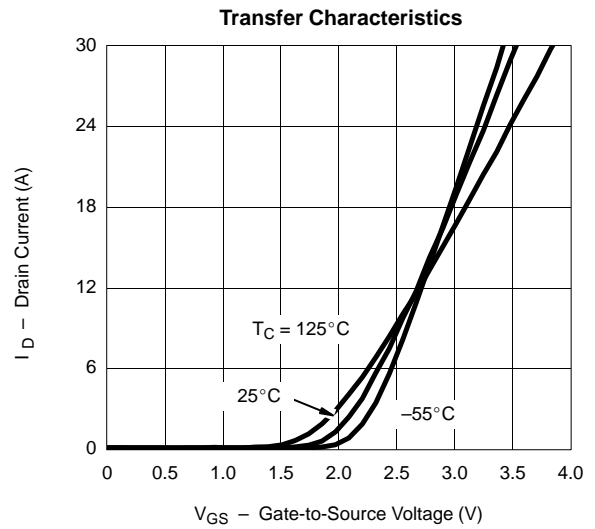
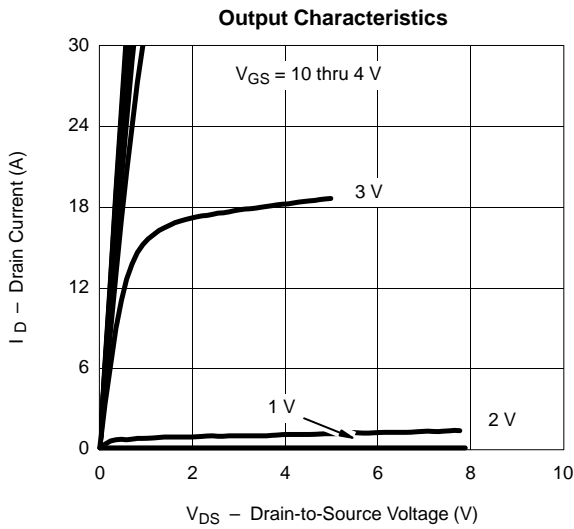



TYPICAL CHARACTERISTICS (25°C UNLESS NOTED) CHANNEL-1

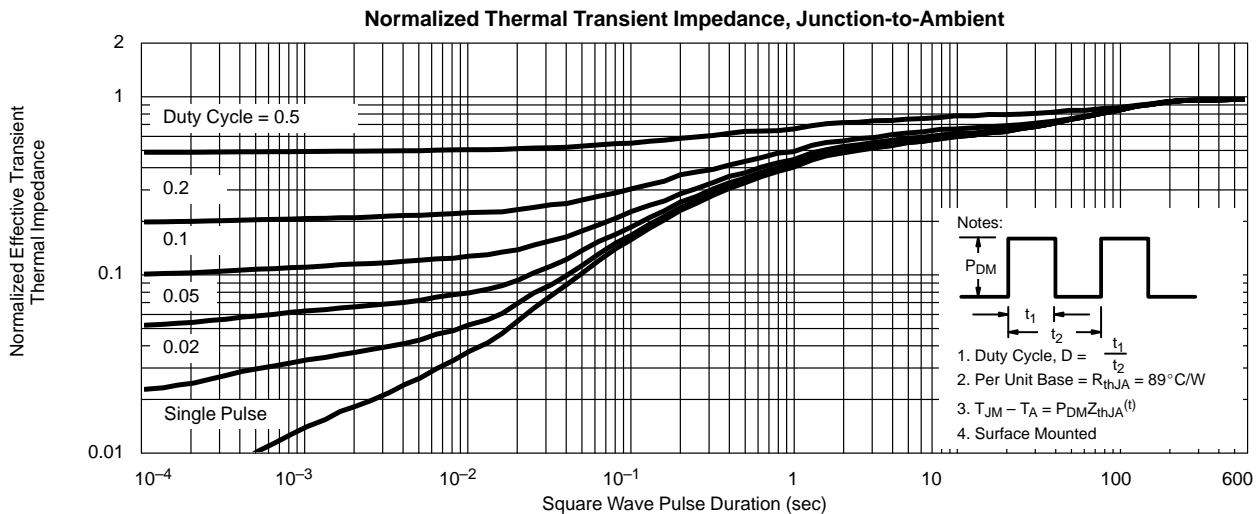
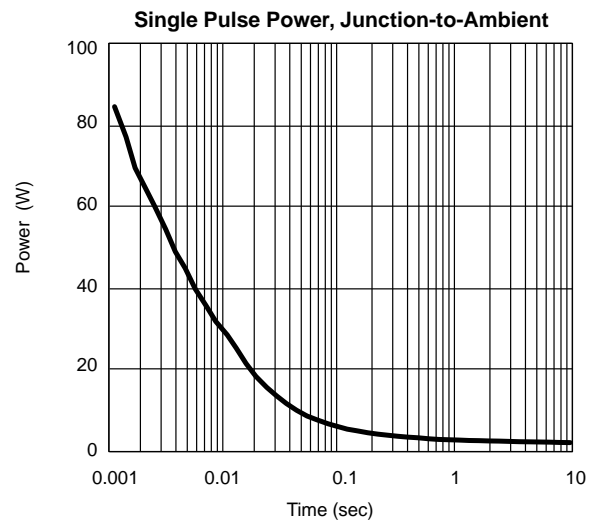
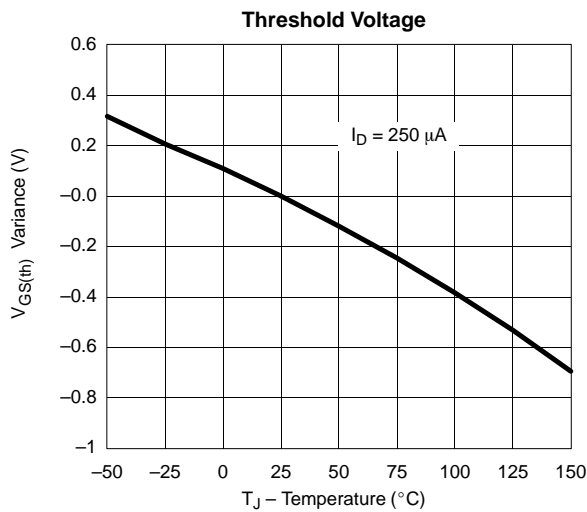
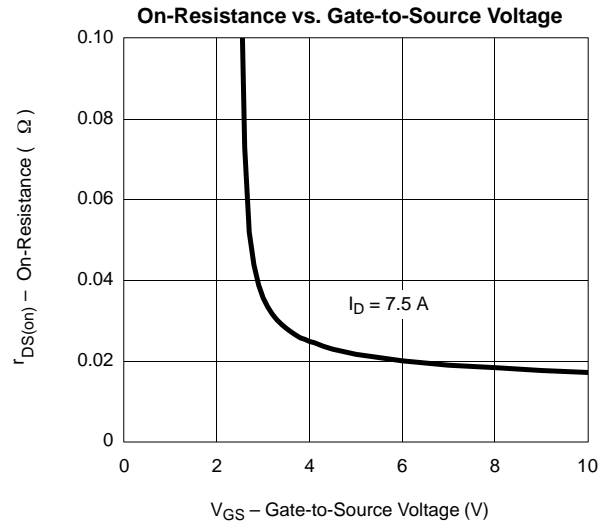
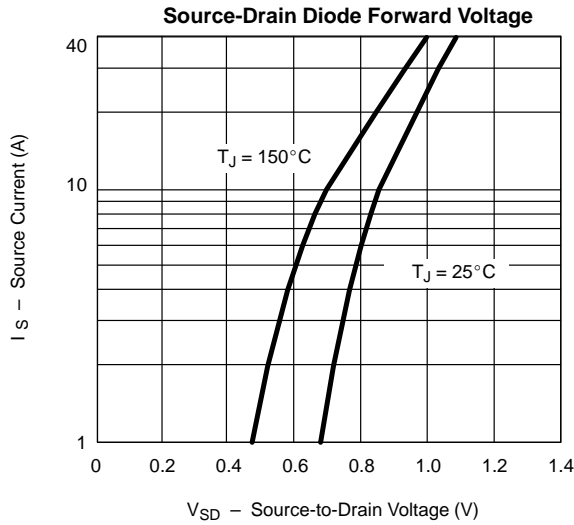



TYPICAL CHARACTERISTICS (25°C UNLESS NOTED) CHANNEL-1

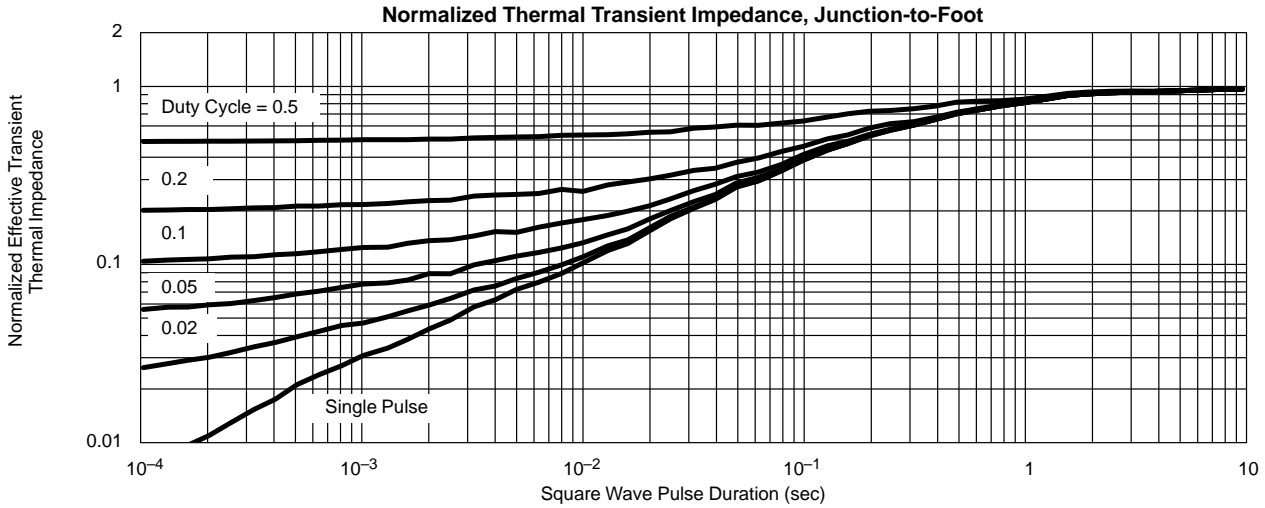

TYPICAL CHARACTERISTICS (25°C UNLESS NOTED) CHANNEL-2

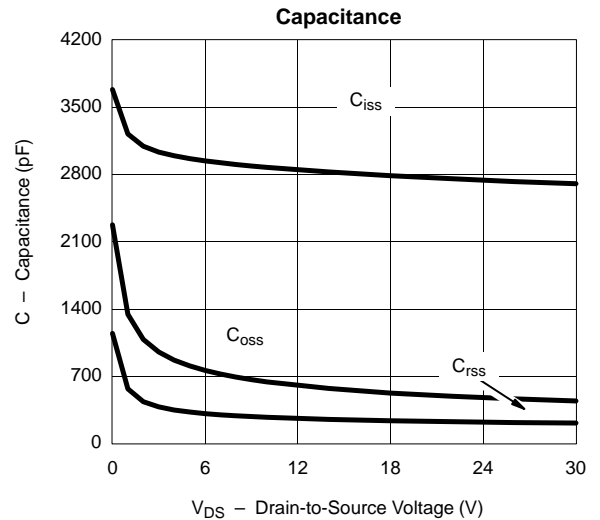
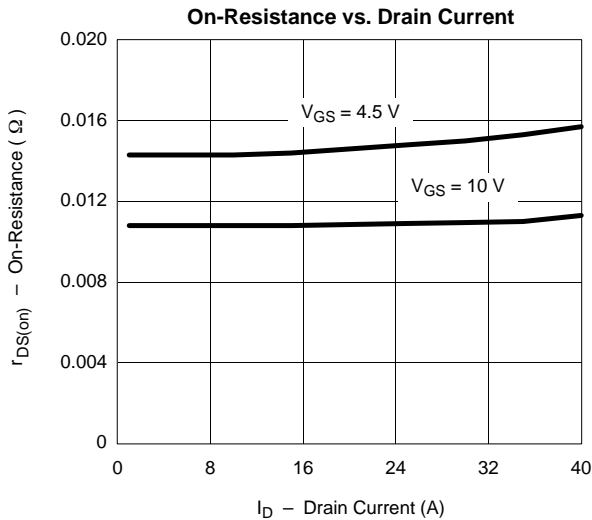
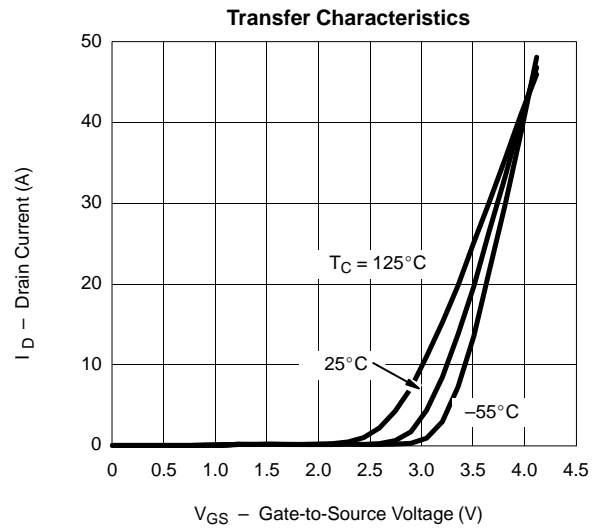
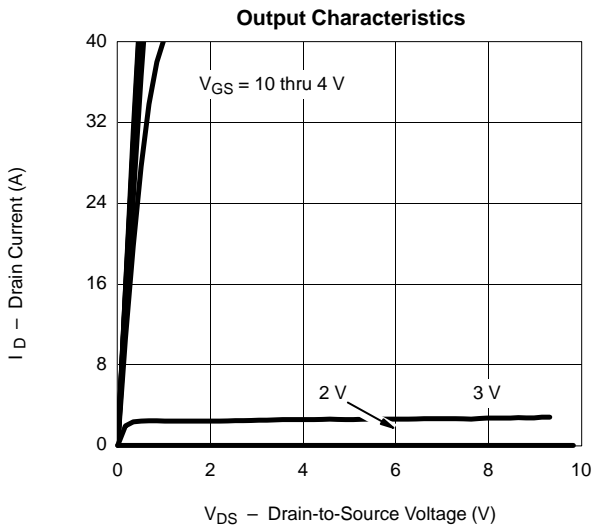



TYPICAL CHARACTERISTICS (25 °C UNLESS NOTED)

CHANNEL-2

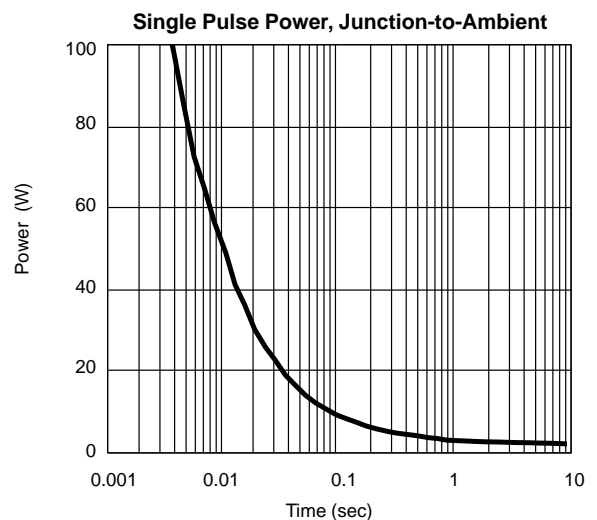
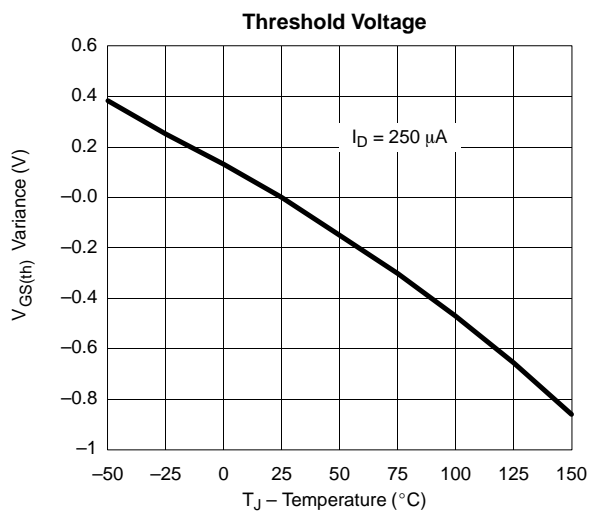
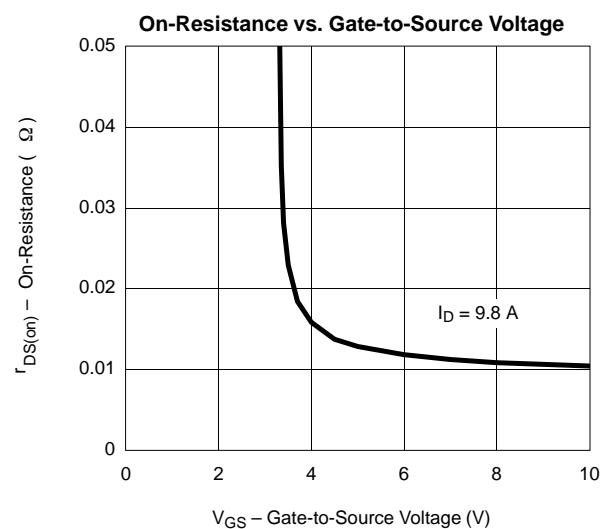
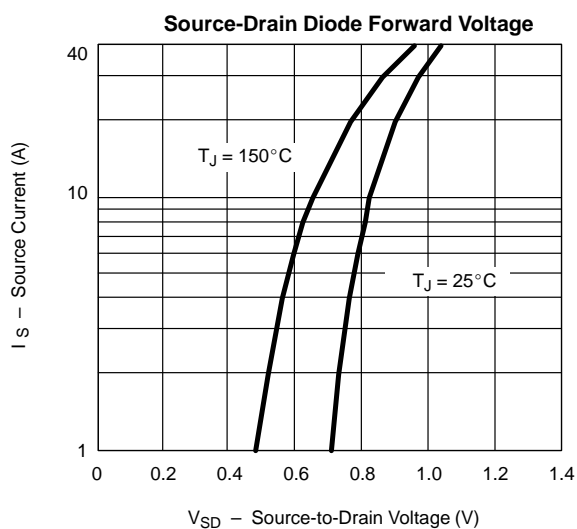
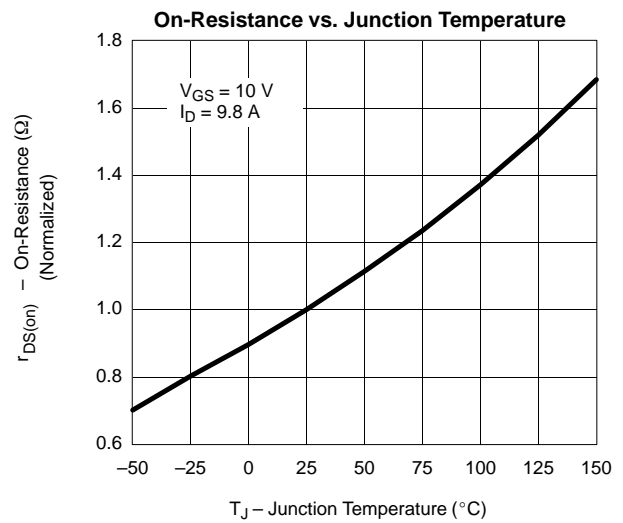
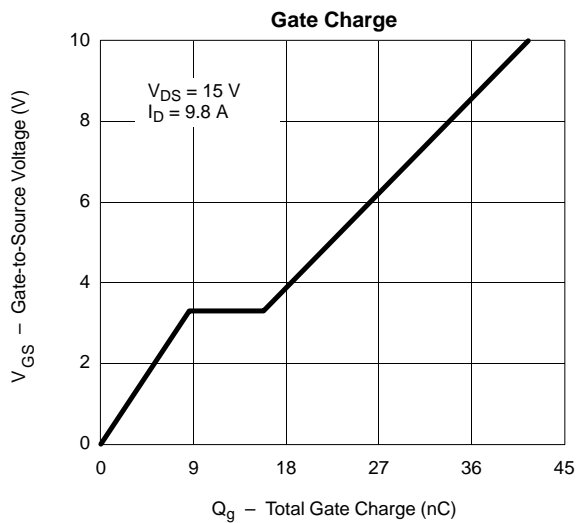



TYPICAL CHARACTERISTICS (25°C UNLESS NOTED) **CHANNEL-2**

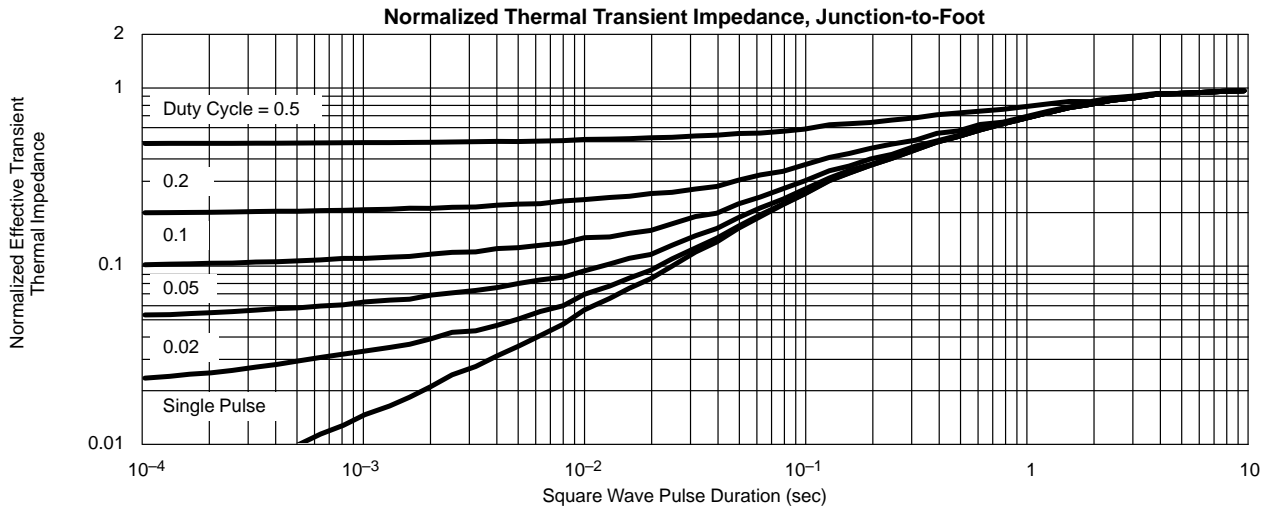
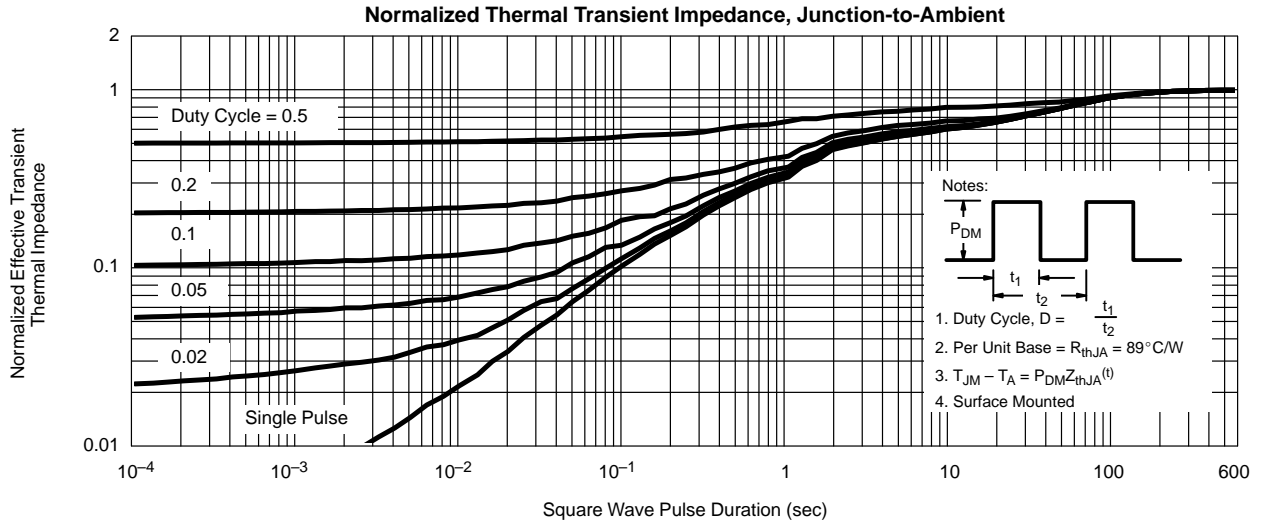



Disclaimer

All product specifications and data are subject to change without notice.

Vishay Intertechnology, Inc., its affiliates, agents, and employees, and all persons acting on its or their behalf (collectively, "Vishay"), disclaim any and all liability for any errors, inaccuracies or incompleteness contained herein or in any other disclosure relating to any product.

Vishay disclaims any and all liability arising out of the use or application of any product described herein or of any information provided herein to the maximum extent permitted by law. The product specifications do not expand or otherwise modify Vishay's terms and conditions of purchase, including but not limited to the warranty expressed therein, which apply to these products.

No license, express or implied, by estoppel or otherwise, to any intellectual property rights is granted by this document or by any conduct of Vishay.

The products shown herein are not designed for use in medical, life-saving, or life-sustaining applications unless otherwise expressly indicated. Customers using or selling Vishay products not expressly indicated for use in such applications do so entirely at their own risk and agree to fully indemnify Vishay for any damages arising or resulting from such use or sale. Please contact authorized Vishay personnel to obtain written terms and conditions regarding products designed for such applications.

Product names and markings noted herein may be trademarks of their respective owners.