

RF Wireless CCT Dimmer

SR-2803A/SR-2803B/SR-2803C

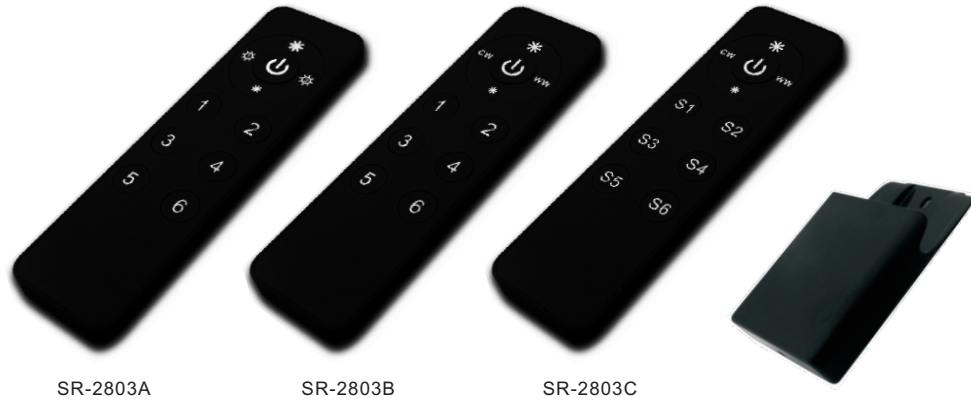

Product Size

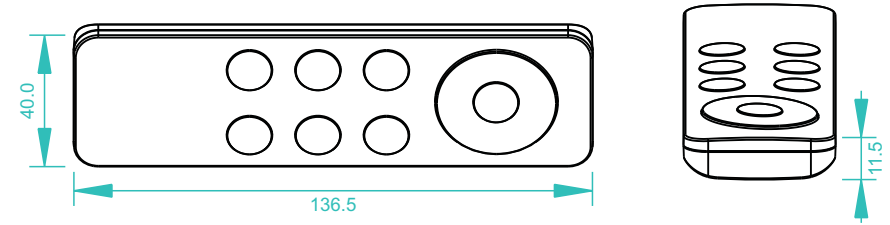

Wiring diagram

1)Receiver Connection Diagram for Single Unit

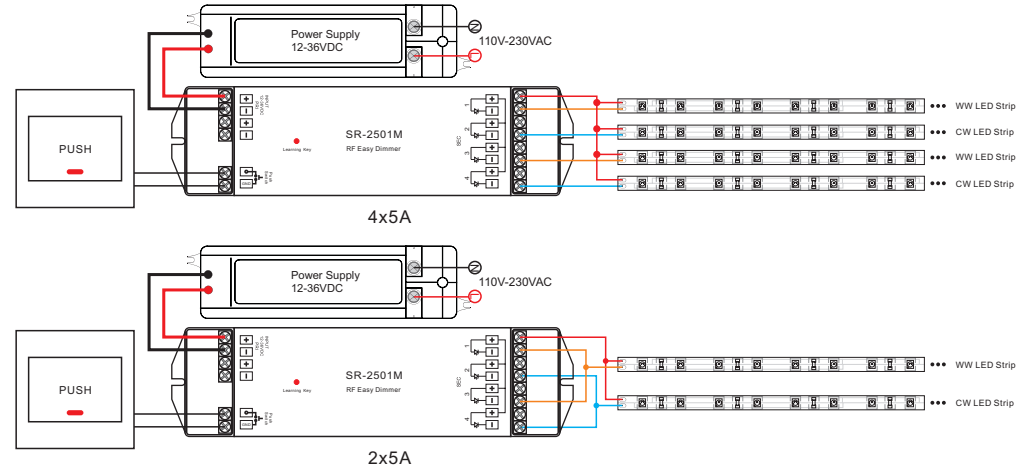

2)Receiver Connection Diagram for Multiple Units

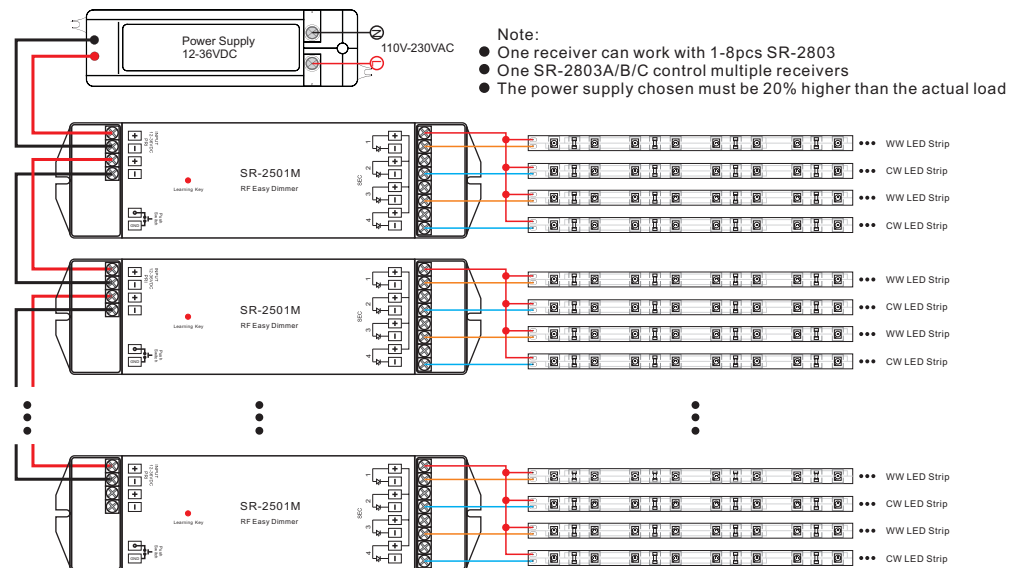

Feature

- SR-2803 A/B/C is RF Wireless CCT Dimmer.
- SR-2803 A/B let you individual ly control up to 6 different zones independently or in a group.
- SR-2803A , dim WW and CW separately, for example if WW is 70%, CW can be 60%. dim 6zones separately or synchronously.
- SR-2803B, dim WW and CW associatively , for example if WW is 70%, CW is 30%. dim 6zones separately or synchronously.
- SR-2803C, dim WW and CW associatively, for example if WW is 60%, CW is 40%. 1 zone. save 6 color temperature.
- Push dim function

Parameter

Remote

| Part No. | Operation Voltage | Operation Frequency | DIMENSIONS ø/h (mm) | Remarks |
|----------|-------------------|---------------------|------------------------|----------------|
| SR-2803A | 3VDC | 434MHz/868MHz | 39X136.5X10.7 | Battery CR2025 |
| SR-2803B | 3VDC | 434MHz/868MHz | 39X136.5X10.7 | Battery CR2025 |
| SR-2803C | 3VDC | 434MHz/868MHz | 39X136.5X10.7 | Battery CR2025 |







Receiver

| Part No. | Input Voltage | Current | Output | Remarks |
|------------|---------------|---------|---------------|------------------|
| SR-2501M | 12-36VDC | 4x5A | 4x(60-180)W | Constant voltage |
| SR-2501MEA | 12-36VDC | 4x8A | 4x(96-288)W | Constant voltage |
| SR-2502M | 12-36VDC | 4x350mA | 4x(4.2-12.6)W | Constant current |
| SR-2503M | 12-36VDC | 4x700mA | 4x(8.4-25.2)W | Constant current |









Brief introduction of buttons







SR-2803A

-  ON/OFF button
-  Control the receiver's Channel 1 and Channel 3  Control the receiver's Channel 2 and Channel 4
-  Turn Up your selected zones' receives'(4 channels together) LED lights
-  Turn down your selected zones' receives'(4 channels together) LED lights
-  Six zones

SR-2803B

-  ON/OFF button
-  Control CW  Control WW
-  Turn Up your selected zones' receives'(4 channels together) LED lights
-  Turn down your selected zones' receives'(4 channels together) LED lights
-  Six zones

SR-2803C

-  ON/OFF button
-  Control CW  Control WW
-  Turn Up your selected zones' receives'(4 channels together) LED lights
-  Turn down your selected zones' receives'(4 channels together) LED lights
-  Save six color temperature

Operation

After you have wired all the receivers according to Figure 1 illustration you need to do the following:

1. Pull off the plastic film cover of the battery at the back of remote.
2. If you use multiple receivers, you have 2 choices:
 - 1) Have all receivers in the same zone like Zone 1 for example
 - 2) Have each receiver in a different zone, like Zone 1, 2, 3 and so on
3. In order for each receiver to know what Zone it belongs to, you will need to "pair" it to the zone you wish to use: short press the Learning Key on the receiver, and immediately short press the zone number (1-6) which you wish to use(for example 1).

Once you do that, the LED lights will blink once. Now your remote and receiver are paired!

4. Do the same for the other receivers if you use them.

This wireless receiver can work in any of the 6 zones. It has a special "Learning Key" that will enable you to pair it to any of the 6 zones in the wireless remote control. You can add as many optional receivers as you wish, to create up to 6 different control zones. Each zone can have an endless number of receivers.

Memory Reset:

In case you want to reset the memory of the receiver, press the learning function button for 10 seconds while the unit is being powered. The unit will then reset to factory defaults.



Re-Assign Zone:





Re assigning the receiver to a different zone is easy, just repeat Step 3 as above.

 button to turn ON/OFF all zones' LED lights.

Long press the zone number for 3 seconds to turn OFF that zone separately (for example 1), and you can turn it ON only by long press that zone number again, but Not the power button.

After ID learning between remote and receiver, press the zone number(for example 1) to select the zone you want to control.

Regarding SR-2803C saving color temperature, first choose CCT you like, short press  , the light will be blink, it means you save this CCT to  , then you also can save other 5 CCT to S2-S6. Just press S1-S6, can recall 6 CCT you saved separately.

Note: If the max brightness is set by   , then, you can not turn UP beyond that max brightness by   .

Safety & Warnings

- 1) The product shall be installed and serviced by a qualified person.
- 2) IP20. Please avoid the sun and rain. When installed outdoors, please ensure it is mounted in a water proof enclosure.
- 3) Always be sure to mount this unit in an area with proper ventilation to avoid overheating.
- 4) Please check if the output voltage of any LED power supplies used comply with the working voltage of the product.
- 5) Never connect any cables while power is on and always assure correct connections to avoid short circuits before switching on.
- 6) Please ensure that the cable is secured tightly in the connector
- 7) For update information please consult your supplier.

Warranty Agreement

- 1) We provide lifelong technical assistance with this product:
 - 3-year warranty. We print date on every products, for example :1125 means year 2011, week 25. The warranty is for free repair or replacement and covers manufacturing faults only.
 - For faults beyond the 3-year warranty we reserve the right to charge for time and parts.
- 2) Limited Warranty
 - Any defects caused by wrong operation.
 - Any damages caused by unauthorized removal, maintenance, modifying, incorrect connection and replacement of chips.
 - Any damages due to transportation, vibration etc. after purchase.
 - Any damages caused by earthquake, fire, lightning, pollution and abnormal voltage.
 - Any damages caused by negligence, inappropriate storing at high temperatures and humidity or near harmful chemicals.
 - Product has been updated
- 3) Repair or replacement as provided under this warranty is the exclusive remedy to the customer.